

IMSE **Ultra**

Configuration manual

UltraBase20

UltraBase30

UltraBase30+

UltraBase40

Valid for release 1.104.X

2026-04-15

Innehåll

- 1 Introduction 10**
 - 1.1 Other Manuals 11
 - 1.2 Safety and Important Information 11
 - 1.2.1 Installation and Protection 11
 - 1.2.2 Electromagnetic compatibility 12
 - 1.2.3 Cleaning 12
 - 1.2.4 Recycling 12
 - 1.3 Repair and service 12
 - 1.4 Contact Information 12
 - 1.5 Warranty 13

- 2 Installation IMSE UltraBase20 14**
 - 2.1 Power supply 15
 - 2.2 Connect Sensors and Actuators 15
 - 2.2.1 Analog outputs 15
 - 2.2.2 Digital outputs 16
 - 2.2.3 Temperature sensor inputs 16
 - 2.2.4 Analog inputs 16
 - 2.2.5 Digital inputs 17

- 3 Installation IMSE UltraBase30 18**
 - 3.1 Power Supply 19
 - 3.2 Connect Sensors and Actuators 19
 - 3.2.1 Universal Inputs 19
 - 3.2.2 Digital Inputs 21
 - 3.2.3 Analog Outputs 21
 - 3.2.4 Digital Outputs 21

- 4 Installation IMSE UltraBase30+ 23**
 - 4.1 Power supply 24
 - 4.2 Connect Sensors and Actuators 24
 - 4.2.1 Universal inputs 24
 - 4.2.2 Digital inputs 25
 - 4.3 Digital outputs 26
 - 4.4 Analog outputs 26

5	Installation IMSE UltraBase40	27
5.1	Power supply	28
5.2	Connect Sensors and Actuators	28
5.2.1	Analog outputs	28
5.2.2	Digital outputs	29
5.2.3	Temperature sensor inputs	29
5.2.4	Analog inputs	29
5.2.5	Digital inputs	30
6	Start-up	31
6.1	Network Connection	31
6.2	ETHERNET	31
6.3	LOCAL PC	31
6.4	Login and Password	32
6.4.1	Warnings when logging in	32
6.5	Overview User Interface	33
6.6	Connect Expansion Modules	37
7	Applications & Resources	38
7.1	Applications	38
7.2	Channels	38
7.3	Alarms	39
7.4	Alarm Groups	39
7.5	Parameters	39
7.6	Curves	39
7.7	Time Schedule	40
8	Graphical Programming	41
8.1	Create Substation and Ventilation Controllers	41
8.2	Create Graphical Programs	43
8.2.1	Create a Template of an application	52
8.2.2	Application backups	54
8.3	Channels	55
8.3.1	Channel logs	57
8.4	Alarms	58
8.5	Alarm Groups	60
8.6	Curves	62
8.7	Parameters	64

8.8	Time Schedules	65
8.8.1	Date	66
8.8.2	Weekly	67
8.8.3	Monthly	69
8.8.4	Yearly	69
8.8.5	Periodically	71
8.9	Applications Status	71
8.10	Overview Icons Graphical Programming	72
8.11	Explanation of the Different Components	75
9	Overviews	82
9.1	Create a New Overview	82
9.1.1	Add Backgrounds	83
9.1.2	Add Resources	84
9.1.3	Create custom symbol libraries	86
9.1.4	Add Text Boxes and Links	86
9.1.5	Create copy of an Overview	87
9.2	Tools	87
9.3	View Alternatives	88
9.4	Keyboard shortcuts	88
10	Summaries	90
10.1	Create a New Summary	90
10.2	Summary Tools	94
10.3	View Alternatives	95
10.4	Channels	95
10.5	Alarms	97
10.6	Time Schedules	97
10.7	Parameters	97
10.8	Curves	98
10.9	Overview in- & outputs	98
10.10	Summaries in summaries	99
11	Alarms	100
11.1	Active Alarms	100
11.2	Alarm Types	100
11.3	Edit Alarms	100
11.4	Create Alarm Groups	103
11.5	Alarm Sendouts	106

11.6	Events/Errors and Messages	107
12	Data logs	109
12.1	Types of logs	109
12.2	Create logs	111
12.3	View logs	111
12.3.1	Add a log to a plot	112
12.3.2	Selection of time period	113
12.3.3	Logs	113
12.4	Zoom and pan	114
12.4.1	Zoom with mouse wheel	114
12.4.2	Zoom with selection	114
12.4.3	Pinch zoom (only works with touch screen)	114
12.4.4	Reset zoom	114
12.4.5	Pan	114
12.5	Tooltip	114
12.6	Saved views	115
12.6.1	Create saved view	115
12.6.2	Delete saved view	115
12.6.3	Modify saved view	115
12.6.4	Export data	115
12.7	Log sendouts	115
13	Inputs & Outputs	119
13.1	Overview	119
13.2	Details Inputs and Outputs	119
13.2.1	Universal Inputs	119
13.2.2	Digital Inputs	120
13.2.3	Analog Outputs	120
13.2.4	Digital Outputs	120
13.3	Configure Sensors and Actuators	120
13.3.1	Configure Expansion Modules	122
13.4	Replacing an Expansion Module	124
14	External Units	125
14.1	Configure External Units with definition scripts	126
14.2	Configure external Modbus units	128
14.2.1	Modbus registers	130
14.2.2	Function codes	130

14.2.3	Readable and writeable registers	131
14.2.4	Register types and scaling	131
14.2.5	Update time and limitations	131
14.2.6	Export and use templates	132
14.3	Statistics and troubleshooting	132
14.4	Status	132
15	Web Shares	134
15.1	Create an Auto-export	134
15.2	Create an Export via I/O-unit	137
15.3	Create an Import via I/O-unit	141
15.4	Error Status	145
16	Manual Override	146
16.1	Allow Manual Override	146
16.2	Activate Manual Override	146
17	System	150
17.1	Notes	150
17.2	File Manager	150
17.3	Users	152
17.4	Settings	155
17.4.1	Settings	156
17.4.2	Choose start page	156
17.4.3	Set time	157
17.4.4	Time zone	157
17.4.5	Other settings	157
17.4.6	Clear history	158
17.4.7	Reboot	158
17.5	Backups	158
17.5.1	Create a new application backup	159
17.5.2	Create new system backup (UltraBase30+)	159
17.5.3	Create new system backup (UltraBase20, UltraBase30 och UltraBase40)	160
17.5.4	Create an automatic system backup	161
17.5.5	Backup to SD-card using buttons on UltraBase30	161
17.6	Update	162
17.6.1	Expansion modules	163
17.7	Information	164
17.8	Change history	165

18 Help	166
18.1 Support	166
18.1.1 Contact information	166
19 Communication	167
19.1 Network	167
19.2 Mail Host	168
19.3 Recipients	169
19.4 Modbus Slave Register	169
19.4.1 Register types	174
19.4.2 Time schedules in Modbus	174
19.5 Modbus slave settings	178
19.6 Modbus TCP Gateway	179
19.7 RS485 Ex settings	186
19.8 External devices sendouts	187
19.9 Portal Update	188
19.9.1 Status	189
19.10 Companion	189
19.10.1 Configuring connected devices	190
19.10.2 Configuring before plant is connected	193
19.10.3 View alarms	195
19.10.4 Home, overviews and summary pages	196
19.10.5 Safety	196
20 IMSE Ultra OP	198
20.1 Connection and function overview	198
20.2 Get started with your operator panel	199
20.3 Menu overview	199
20.4 Custom menus	199
21 Technical Specification IMSE UltraBase20	201
21.1 Temperature Inputs	201
21.2 Analog inputs	201
21.3 Digital Inputs	201
21.4 Analog outputs	202
21.5 Digital relay outputs	202
21.6 Communication	202
21.6.1 Ethernet	202
21.6.2 Ethernet Local PC	202

21.6.3	RS485	203
21.6.4	Ex Out	203
21.6.5	MBus	203
21.7	Processor unit	203
21.8	Other	203
22	Technical Specification IMSE UltraBase30	205
22.1	Universal Inputs	205
22.2	Digital Inputs	207
22.3	Analog outputs	207
22.4	Digital outputs	207
22.5	Communication	208
22.5.1	Ethernet	208
22.5.2	Ethernet Local PC	208
22.5.3	RS485	208
22.5.4	Ex Out	208
22.6	Processor unit	208
22.7	Other	209
23	Technical Specification UltraBase30+	210
24	Technical Specification IMSE UltraBase40	211
24.1	Temperature Inputs	211
24.2	Analog inputs	211
24.3	Digital Inputs	212
24.4	Analog outputs	212
24.5	Digital outputs	212
24.6	Communication	212
24.6.1	Ethernet	212
24.6.2	Ethernet Local PC	213
24.6.3	RS485	213
24.6.4	Ex Out	213
24.7	Processor unit	213
24.8	Other	213
25	Resistance measurement range	215
25.1	Measurement accuracy UltraBase20	215
25.2	Measurement accuracy UltraBase30	215
25.3	Measurement accuracy UltraBase30+	217

25.4 Measurement accuracy UltraBase40	218
26 Term Definitions	218

All information in this manual is based on information available at the time of printing. The manual is published to ease the use of an Ultra. Abelko Innovation cannot guarantee that there are no mistakes or errors in this documentation and cannot be held responsible for any consequences resulting from the use or misuse based on this information.

All information in this document can be changed without notice. It is likely that certain sections will be changed at the release of new product versions. Be sure to have the latest version of this document and the corresponding version of Ultra.

© Abelko Innovation. All Rights Reserved.

1 Introduction

Welcome to IMSE Ultra. This series of products consists of the control units IMSE UltraBase20, IMSE UltraBase30, IMSE UltraBase30+, IMSE UltraBase40, operator panel IMSE Ultra OP and expansion modules that can be connected to expand the number of inputs and outputs.

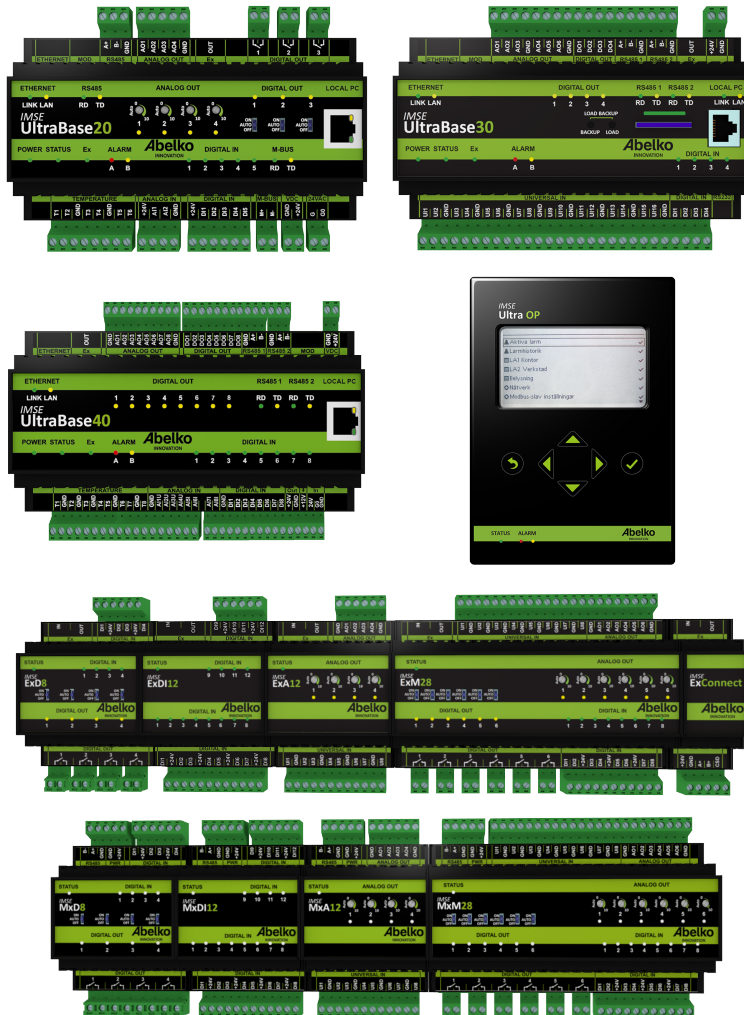

This configuration manual is mainly for the person configuring the Ultra system. It aims to provide a guide on how to use the system in the easiest and most effective way.

1.1 Other Manuals

User manual: a guide for how to use the configured system.

Reference manual: more detailed technical information and script programming.

Quick start guide: information on how to quickly get the system up and running.

Referensmanual IMSE Expansionsmoduler more detailed technical information about expansion modules (only in Swedish).

All manuals are available for download at www.abelko.se

1.2 Safety and Important Information



All users of UltraBase20, UltraBase30, UltraBase30+ or UltraBase40 must carefully read the manual and take necessary safety precautions. The term Ultra when used in this manual refers to any of these products. If the product is not used as intended its protection and safety functions may not work.

1.2.1 Installation and Protection

Electrical installation work may only be carried out by qualified electricians in accordance with the applicable regulations. **The equipment must be unplugged from the mains and other possibly dangerous voltage sources during installation and service.**

At high ambient temperatures there is a risk for burning injuries. Wait for the equipment to cool down, and use protective gloves.

The unit is to be mounted on a DIN rail in a locked cabinet. Cables must be fastened and secured so that no risk for injury or fire exists. Ventilation openings in the device housing may not be covered.

A circuit breaker shall be installed close to the unit and its power supply. Function and position shall be clearly labelled. This must also be done for dangerous voltages connected to built in relays. Power sources connected to built in relays must be limited to max 2 A current resistive load.

All external equipment connected to the device must have double or enhanced isolation (class II) from power mains or other dangerous voltage source (>50 VAC or > 75 VDC).

Note that all cables used must be approved for at least 50 °C ambient temperature.

The UltraBase units are protected to IP 20, which means they are not water resistant. It must **not be installed where it might be exposed to water of any kind.**

1.2.2 Electromagnetic compatibility

When measurement and control systems are installed, the cables must lie in a way that minimizes magnetic and electric fields. These fields can be influenced by many factors: frequency converters, relays, contactors, earth currents and static discharge. Cable lengths can also affect sensitivity. The installation should be carefully planned to minimize interference.

1.2.3 Cleaning

The housing is cleaned from dust and dirt using a dry cloth. Do not use chemicals.

1.2.4 Recycling

When recycling, sort the product as electronics.

1.3 Repair and service

Reparation and service shall always be performed by Abelko Innovation. Contact your distributor first if the need arises.

1.4 Contact Information

Web page	www.abelko.se
Address	Abelko Innovation Box 808 971 25 Luleå Sweden
E-mail	info@abelko.se

1.5 Warranty

1. Abelko will repair any design, material and manufacturing defects at its own expense, provided they occur during normal use and the purchaser submits a claim within 60 months of the verified delivery date. The purchaser is responsible for removal, re-installation and for paying transport costs to Abelko, and Abelko will repair the defect and return the equipment free of charge to the purchaser.
2. The warranty only covers design, material and manufacturing defects. Abelko is not responsible for defects caused by a failure to follow the instructions, or defects resulting from normal wear and tear, poor maintenance, unauthorized work, noncompliant operating conditions, incorrect installation or repairs not carried out by Abelko or an authorized agent, voltage surges or other electrical faults.
3. Abelko's responsibility for defects is limited to the circumstances described above. Abelko is not responsible for any consequential damage that may occur as a result of design, material and manufacturing defects. The purchaser is therefore not entitled to use defects as grounds for compensation or any other claim, except in the circumstances described above, nor may such claim be made against any third parties responsible for fulfilling this warranty.
4. Abelko is not responsible for restoring any configurations, etc. added by the purchaser. The purchaser should create a backup of configurations and save them to a server.

The information in this document is the property of Abelko Innovation. The content is confidential and unless you have Abelko Innovation's written permission, you may not disclose it to anyone except Abelko Innovation personnel, resellers, agents or licensees. You may not copy parts of the document or save it to data media or other media, including photocopying or recording, unless you have the permission of the copyright holder, Abelko Innovation.

Abelko Innovation makes no guarantees in respect of the content of this document. Abelko Innovation also retains the right to alter, add or remove parts of the document at any time and without notice. Reasons for doing so include printing errors, incorrect information and software/product improvements. Any such changes will always be included in new editions of this document.

All rights reserved.

© Abelko Innovation 2026

2 Installation IMSE UltraBase20

In this chapter, we will explain things you need to know to begin setting up an UltraBase20.

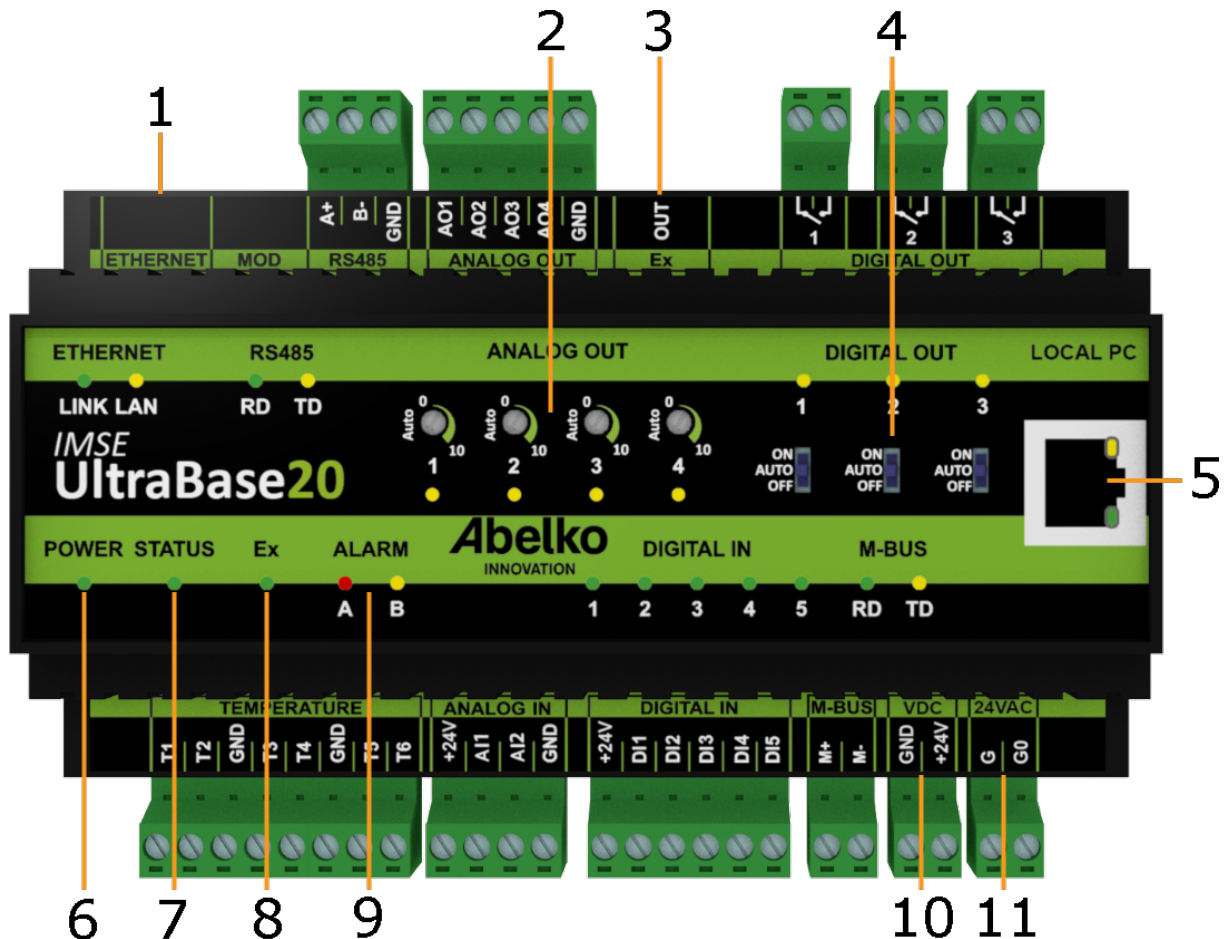

1. **ETHERNET** is used to connect to the network.
2. **ANALOG OUT** manual override. Turn right to activate manual override and increase the output voltage. When the corresponding yellow LED is lit manual override is active. Turn fully left to deactivate.
3. **Ex OUT** is used to connect to expansions modules. This port can also be configured as an RS485-port
4. **DIGITAL OUT** switch for manual override. Set to AUTO for normal operation. A yellow LED indicates a closed relay output.
5. **LOCAL PC** is used only for direct connection to a PC with address **https://192.168.142.1**.
6. **POWER** shines green when the unit is powered.
7. **STATUS** shines green when the unit is running. It may take a little while before STATUS lights up when the unit is powered. If it does not light up, inputs and outputs are not working. If the status

LED blinks, there is something wrong, go to menu Active Alarm for more information about the error.

8. **Ex** shines green when all the expansion modules that should be connected are running. If it blinks, a module is missing. Ex does not shine if the port is configured as RS485
9. **ALARM** has one red LED for A-alarms and one yellow LED for B-alarms. The LEDs blink if there are alarms that need to be acknowledged.
10. **VDC** is used to power the Ultra with 24 V stabilized DC.
11. **24VAC** is used to power the Ultra with 24 V AC power. Ex OUT is not powered on AC power.

2.1 Power supply

UltraBase20 can be powered in several ways. Requirements and characteristics of the unit's inputs and outputs can be found in the table below.

Port	Supply	Supply expansion module (port Ex)
VDC	24 VDC* (>300 mA)	24 VDC, 1A
24VAC	24 VAC (>300 mA)	No
	24 VDC* (>300 mA)	No

* Stabilized DC voltage.

The **Power** LED lights up when the device is energized and the **Status** LED lights up when the device has started up and is working.

2.2 Connect Sensors and Actuators

2.2.1 Analog outputs

Analog outputs for 0-10 V, marked AO, are located on the upper terminal strip. The figure below is an example on how you can connect an AC-powered valve controller.

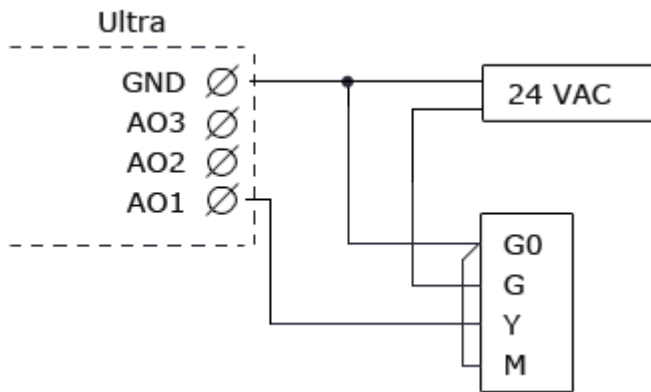

2.2.2 Digital outputs

Digital outputs, marked DO, are located on the upper terminal strip. They are normally open relays with breaking capacity of 250 VAC/2A or 30 VDC/2A with resistive load.

2.2.3 Temperature sensor inputs

On the lower terminal row, there are inputs for resistive temperature sensors marked with T. They have a measurement range of 800 to 1600 Ohms and works for example with PT1000 sensors (approximately -50°C to 150°C) and Ni1000 sensors. Temperature inputs can also be used as digital status inputs for potential-free switches.

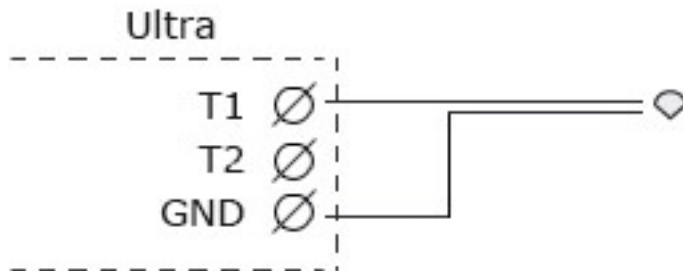

2.2.4 Analog inputs

On the lower terminal row there are two analog inputs marked AI. These can be configured to measure 0-10 V or 0-20 mA.

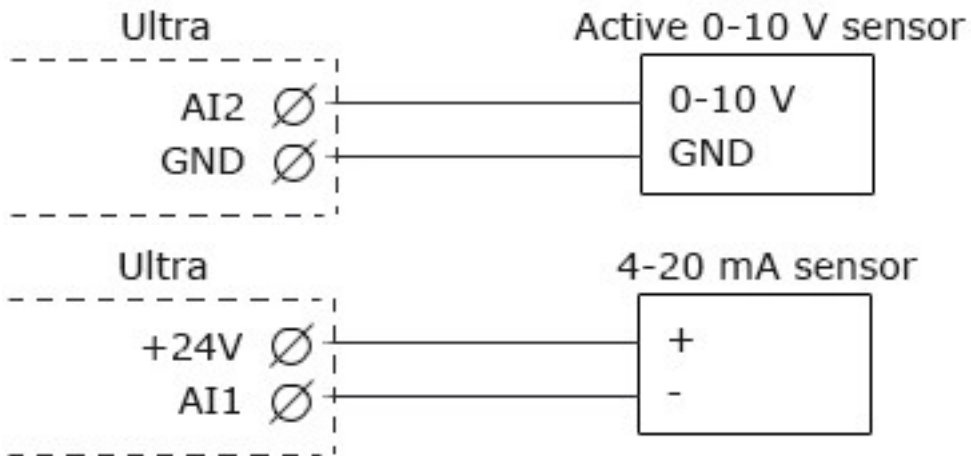

2.2.5 Digital inputs

Five digital inputs, marked DI, are located on the lower terminal strip. These can be used for digital status, counters and frequency measurement.

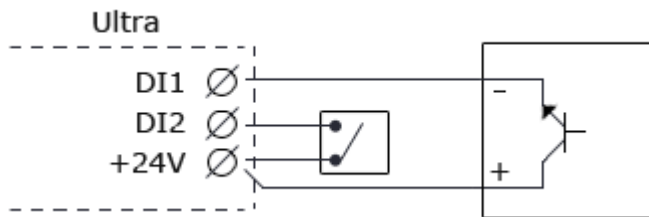

3 Installation IMSE UltraBase30

In this chapter, we will explain things you need to know to begin setting up an UltraBase30.

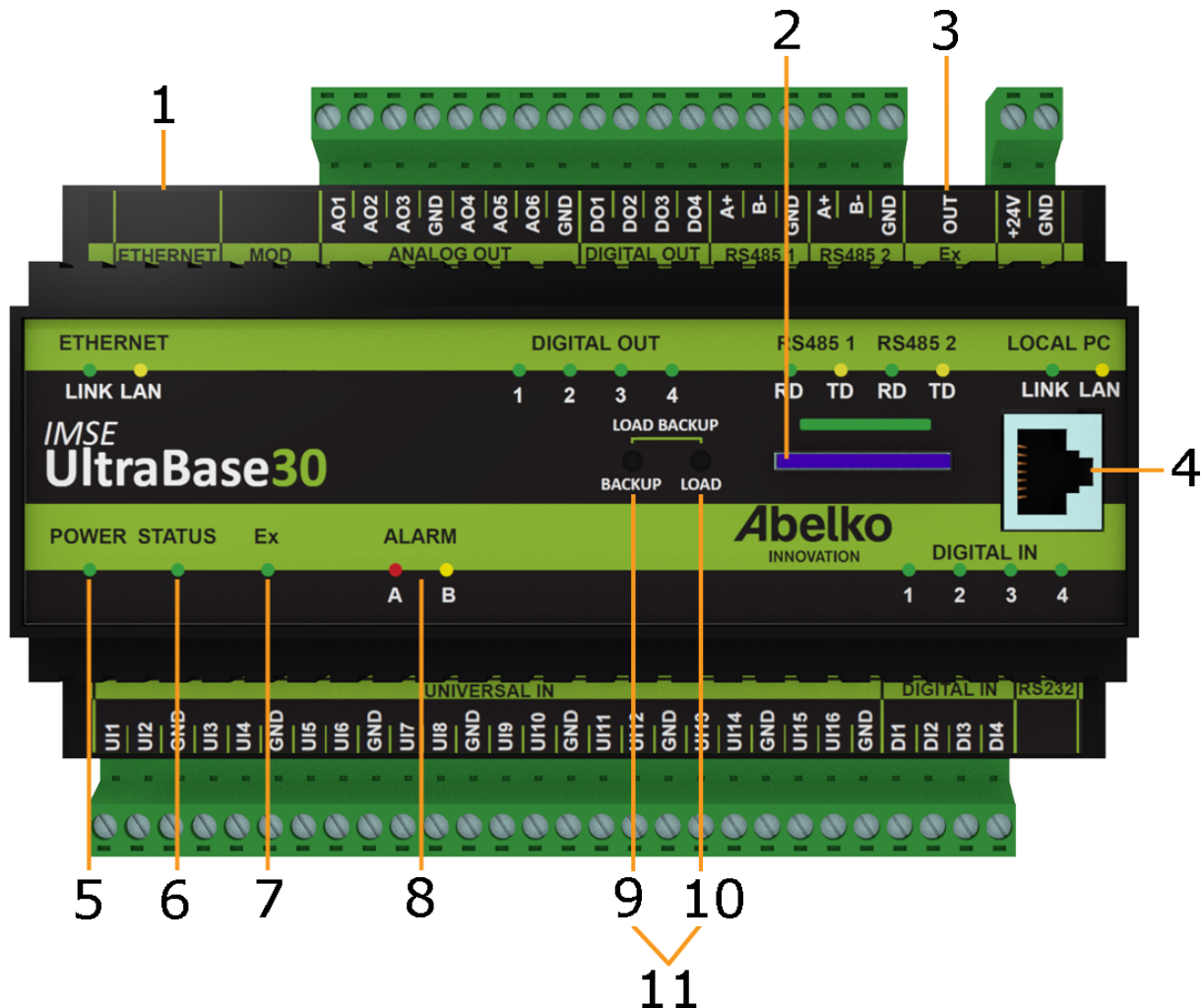

1. **ETHERNET** is used to connect to the network.
2. Place for SD card.
3. **Ex Out** is used to connect to expansions modules. This port can also be configured as an RS485-port
4. **LOCAL PC** is used only for direct connection to a PC with the address **https://192.168.142.1**.
5. **POWER** shines green when the unit is powered.
6. **STATUS** shines green when the unit is running. It may take a little while before STATUS lights up when the unit is powered. If it does not light up, inputs and outputs are not working.

7. **Ex** shines green when all the expansion modules that should be connected are running. If it blinks, a module is missing. Ex does not shine if the port is configured as RS485
8. **ALARM** has one red LED for **A-alarms** and one yellow LED for **B-alarms**.
9. **BACKUP** is used to create a full backup of the system to the SD card.
10. **LOAD** is used to execute a .load file stored on the SD card. There may only be one .load file on the card. A .load file can contain a software upgrade or other commands that will be executed.
11. **LOAD + BACKUP** is pressed simultaneously to restore the latest backup stored on the SD-card.

3.1 Power Supply

UltraBase30 is powered by 24 V DC, through the terminal marked **+24V** and **GND**.

Requirements and characteristics of the unit's inputs and outputs can be found in the table below.

Port	Supply	Supply Expansion module (port Ex)
+24V/GND	24 VDC* (>300 mA)	24 VDC, 1A

* Stabilized DC voltage.

The **Power** LED lights up when the device is energized and the **Status** LED lights up when the device has started up and is working.

3.2 Connect Sensors and Actuators

3.2.1 Universal Inputs

Universal inputs, marked **UI**, are located on the lower terminal strip. Universal inputs can be used for both resistive temperature sensors, voltage 0-10 V and current 0-10 V. UI can also be used as a digital status input for potential-free switches. You need to make settings for the various sensors. This is done under the menu **Configuration, In- & outputs**.

Resistive temperature sensors

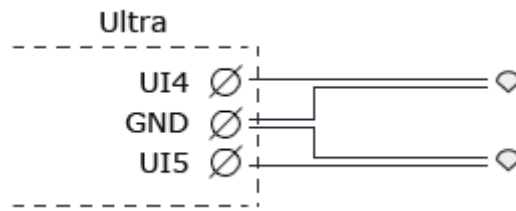

Voltage 0-10 V

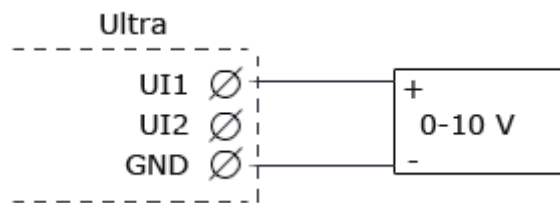

Current 0-20 mA

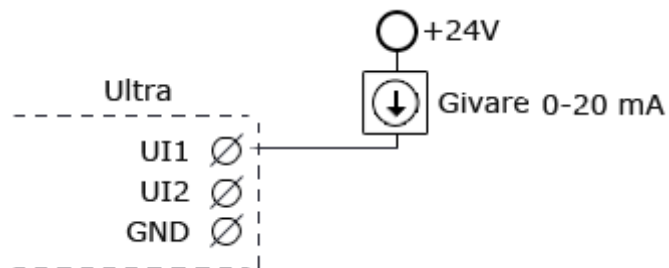

Digital status input for potential-free switches

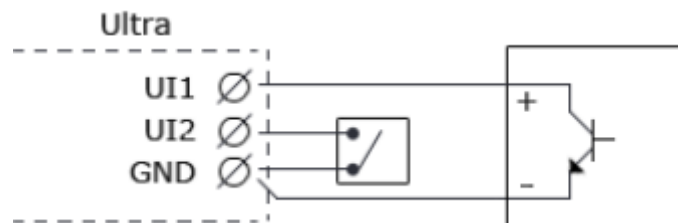

3.2.2 Digital Inputs

Digital inputs, marked **DI**, are located on the lower terminal strip. These can be used for digital status, counters and frequency

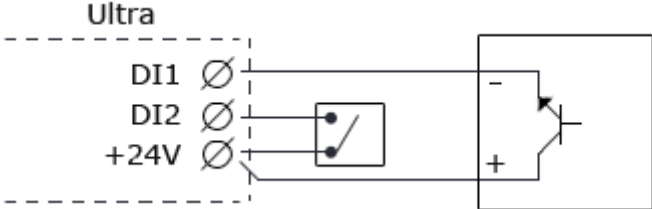

3.2.3 Analog Outputs

Analog outputs 0-10 V, marked **AO**, are located on the upper terminal strip. The following figure is an example on how you can connect an AC-powered valve actuator.

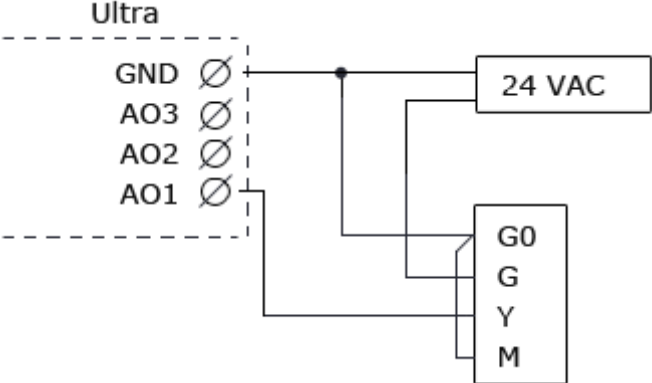

3.2.4 Digital Outputs

Digital outputs, marked **DO**, are located on the upper terminal strip. Digital outputs are open collector that closes to ground (GND) when they are activated.

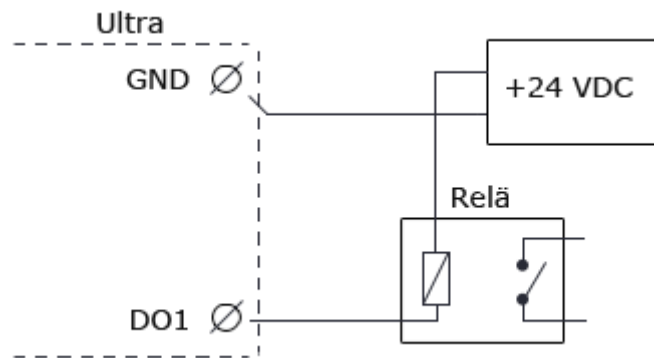

For more detailed information see chapter Technical Specification IMSE UltraBase30. You can configure all of these sensors and actuators in the interface under the menu **Configuration** and **In- & outputs**. Read more about this in chapter **In- & Outputs**.

4 Installation IMSE UltraBase30+

In this chapter, we go through what you need to know to quickly get started with UltraBase30+

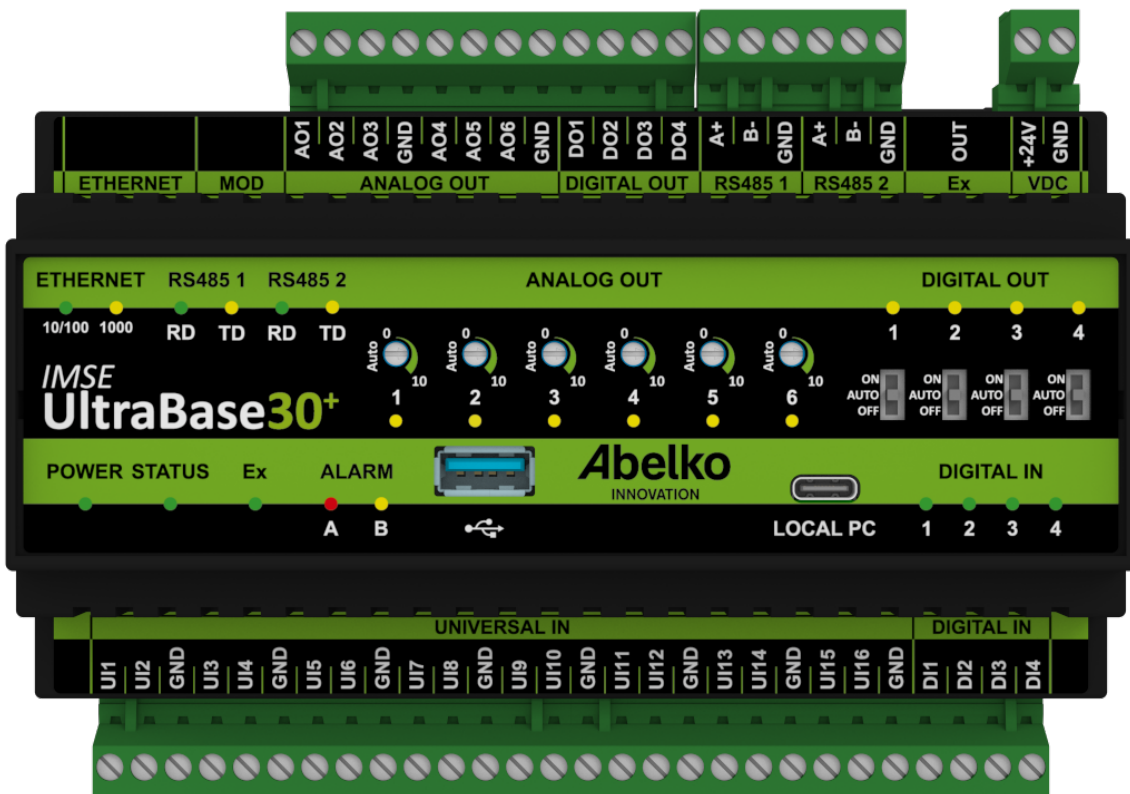

1. **ETHERNET** is used to connect to a network.
2. **USB-A port**. Used for backup management with a USB flash drive.
3. **Ex OUT** is used to connect expansion modules. This port can also be configured as an RS485 port; in that case, for example, an ExConnect is required.
4. **LOCAL PC** USB-C port for direct connection to a PC at the address <https://192.168.142.1>.
5. **POWER** shines green when the device has power.
6. **STATUS** shines green when the device is operating and running. It may take a short while before Status lights up when the device is powered on. If it does not light up, inputs and outputs will not function. If the status LED flashes, something is wrong; go to the Active alarms menu for more information about the error.
7. **Ex** shines green when there is communication with all configured expansion modules. If it flas-

hes, a module is missing. Ex does not light up if the port is configured as RS485.

8. **ALARM** has a red LED for **A alarms** and a yellow LED for **B alarms**. The LEDs flash if there are alarms that need to be acknowledged.

4.1 Power supply

Port	Supply	Supply expansion module (port Ex)
+24V/GND	24 VDC* (>300 mA)	24 VDC, 1A

- Stabilized DC voltage.

The **Power** LED lights up when the device is energized and the **Status** LED lights up when the device has started up and is working.

4.2 Connect Sensors and Actuators

4.2.1 Universal inputs

All universal inputs have the following characteristics:

- Digital input: Activated by connection to GND
- Analog voltage input
- Analog current input
- Resistance input with four measuring ranges

The input type and measuring range are configured via the communication interface. Refer to the device's technical data for electrical specifications.

Example Universal input:

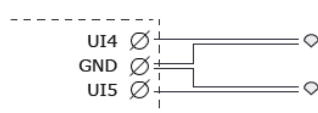

Resistive temperature sensors



Voltage 0-10 V

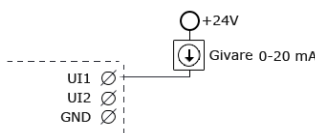

Current 0-20 mA

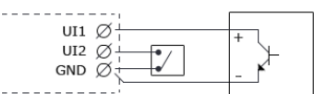

Digital status input for potential-free switches

4.2.2 Digital inputs

All digital inputs have the following characteristics:

- An open input (not connected) is inactive (0).
- Activate (1) the input by applying an external voltage. Switching thresholds: from below 3 V to above 4 V.
- Pulse counter: Maximum 200 Hz, minimum pulse width 2.5 ms.
- Frequency input: 0–200 Hz, minimum pulse width 2.5 ms.

Configuration is performed via the communication interface. A green LED for each input lights up when the input is activated (1) and is off when the input is deactivated (0). The LED blinks if the input detects a frequency above 1 Hz.

The module saves the current counter value every 20 minutes. This means that pulses counted since the last save are lost if power to the unit is interrupted.

Exemple Digital input:

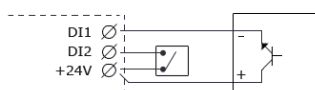

Connect a switch to a digital input

4.3 Digital outputs

Digital outputs are of the open-collector type and connect to ground when activated. The digital outputs have LED indicators that light up when the output is active. The digital outputs can be manually controlled using switches on the front of the device. In the OFF position, the output is always inactive (0). In the ON position, the output is always active (1). In the Auto position, the output is controlled via the communication interface.

4.4 Analog outputs

The analog outputs are voltage outputs, 0–10 V. A control knob on the front of the module can be used to manually set the output. When the knob is set to Auto, the output is controlled via the communication interface. When the output is manually overridden, a yellow LED next to the knob lights up. The voltage to which the output has been manually set can be read via the communication interface.

Exemple Analog output:

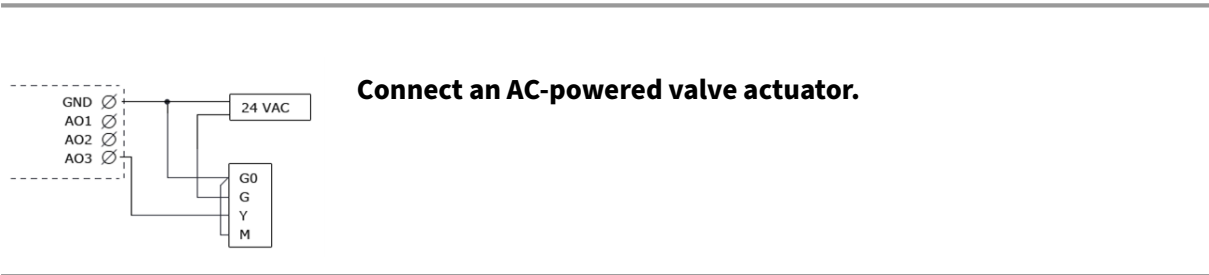

For more information, see the section Technical specification UltraBase30+.

Inputs and outputs are configured in the interface under the **Configuration** and **Inputs & Outputs** menu. This is described in more detail in the chapter Inputs & Outputs.

5 Installation IMSE UltraBase40

In this chapter, we will explain things you need to know to begin setting up an UltraBase40.

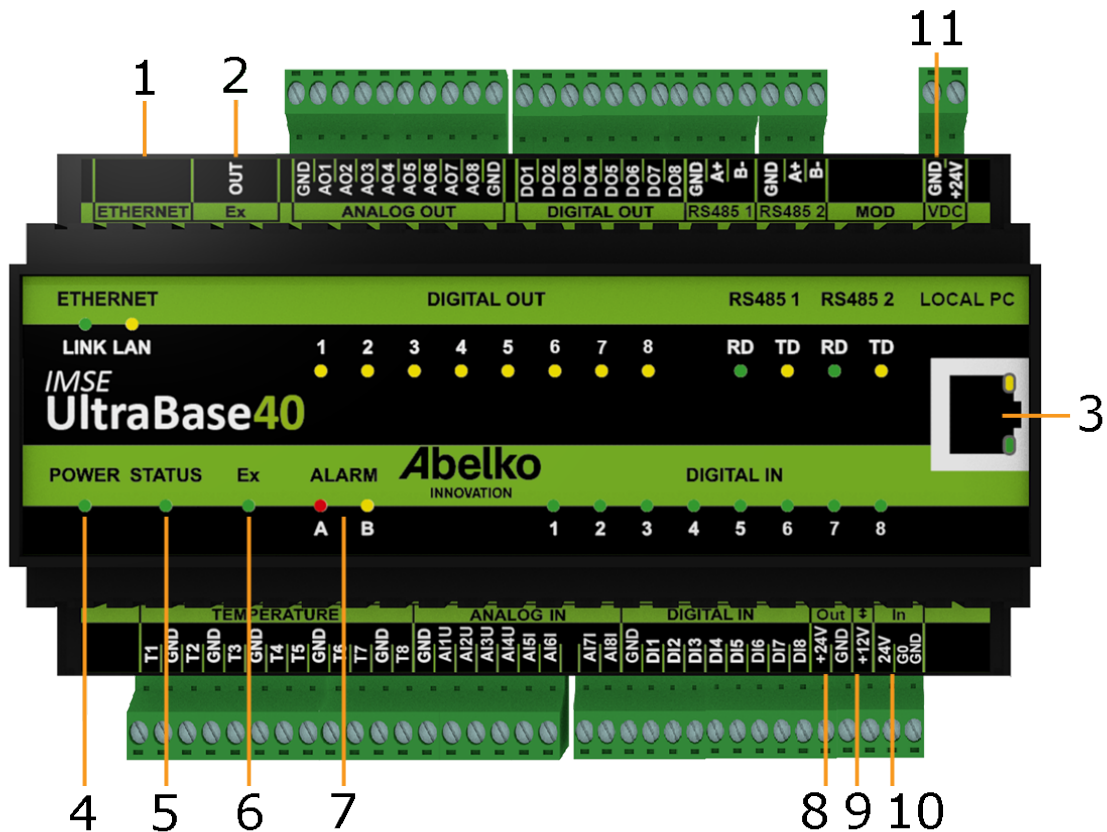

1. **ETHERNET** is used to connect to the network.
2. **Ex OUT** is used to connect to expansions modules. This port can also be configured as an RS485-port.
3. **LOCAL PC** is used only for direct connection to a PC with address **https://192.168.142.1**.
4. **POWER** shines green when the unit is powered.
5. **STATUS** shines green when the unit is running. It may take a little while before STATUS lights up when the unit is powered. If it does not light up, inputs and outputs are not working. If the status LED blinks, there is something wrong, go to menu Active Alarm for more information about the error.
6. **Ex** shines green when all the expansion modules that should be connected are running. If it blinks, a module is missing. Ex does not shine if the port is configured as RS485
7. **ALARM** has one red LED for A-alarms and one yellow LED for B-alarms. The LEDs blink if there are alarms that need to be acknowledged.

8. **Out** +24 V output





9. **(+12V)** is used to power the Ultra with 12 V stabilized DC, or as a +12 V output when the Ultra is powered from another port. Ex OUT is not powered on +12V power.

10. **In** is used to power the Ultra with 24 V AC power. Ex OUT is not powered on AC power.

11. **VDC** is used to power the Ultra with 24 V stabilized DC.

5.1 Power supply

UltraBase40 can be powered in several ways. Requirements and characteristics of the unit's inputs and outputs can be found in the table below.

Port	Supply	Supply expansion module (port Ex)	24 V out (port Out)	 (out +12V)
 (in +12V**)	12 VDC* (>300 mA)	No	No	Not available
VDC	24 VDC* (>300 mA)	24 VDC, 1A	24 VDC, 100 mA	12 VDC, 100 mA
24VAC	24 VAC (>300 mA)	No	No	12 VDC, 100 mA
24VAC	24 VDC* (>300 mA)	No	No	12 VDC, 100 mA

* Stabilized DC voltage.

** Use **GND** from the port **Out**.

The **Power** LED lights up when the device is energized and the **Status** LED lights up when the device has started up and is working.

5.2 Connect Sensors and Actuators

5.2.1 Analog outputs

There are eight analog outputs for 0-10 V, marked **AO**. The figure below is an example on how you can connect an ACpowered valve controller.

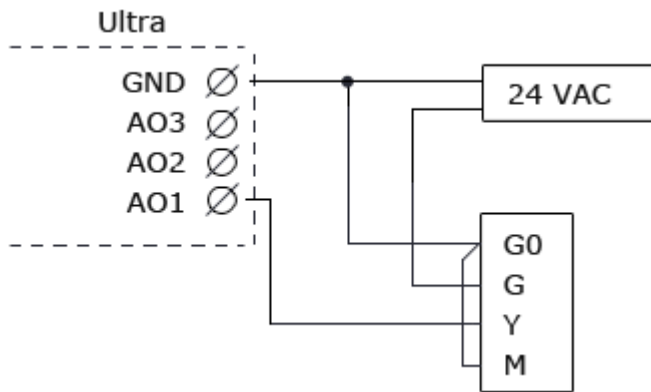

5.2.2 Digital outputs

There are eight digital outputs marked **DO**. These are open drain outputs with breaking capacity 0,5 A and 24 VDC at resistive load.

5.2.3 Temperature sensor inputs

There are eight inputs for resistive temperature sensors marked with **T**. They have a measurement range 800 till 1580 Ohm and works for example with PT1000 sensors (approximately -50°C till 150°C) and Ni1000 sensors. Temperature inputs can also be used as digital status inputs for potential-free switches.

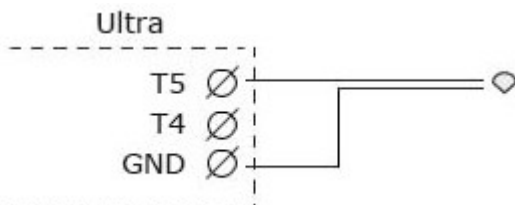

5.2.4 Analog inputs

There are eight analog inputs marked **AI**. Input 1-4 can be set to measure 0-10 V. Input 5-8 can measure 0-20 mA.



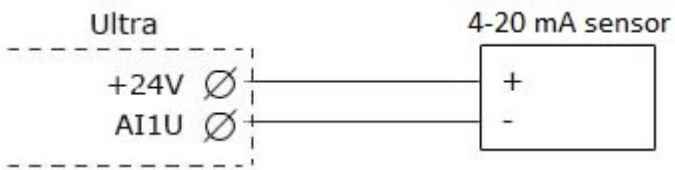

5.2.5 Digital inputs

There are eight digital inputs marked **DI**. Digital inputs can be used for digital status. In addition to this, inputs 1-4 can be used as counters and for frequency measurement.

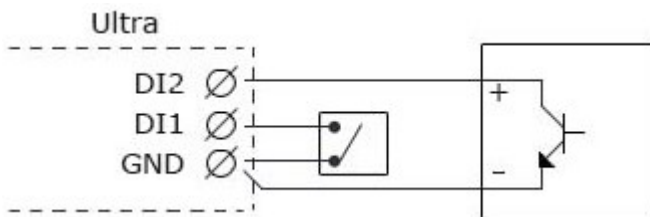

6 Start-up

6.1 Network Connection

To configure settings and access information in an Ultra, it must be connected to a network or a computer. IMSE UltraBase has two ports for network communication, **ETHERNET** and **LOCAL PC**.

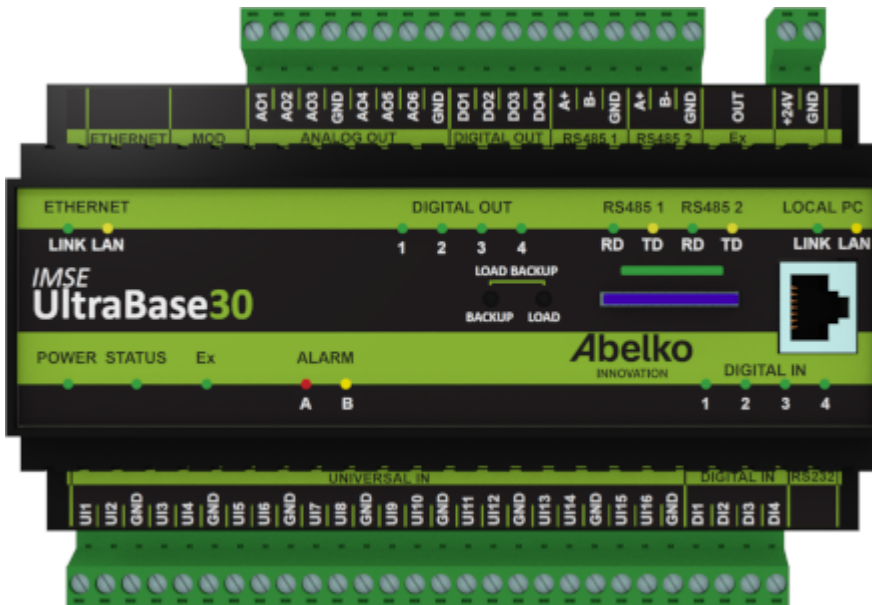

6.2 ETHERNET

ETHERNET is used to connect the device to a wired network. From the factory, it is configured with the IP address 10.0.48.94.

The port's network settings must be changed to match the network it is connected to; see the chapter Network

6.3 LOCAL PC

LOCAL PC is used to connect the unit directly to a PC. The address is **https://192.168.142.1**.

The local PC port has a built-in DHCP server. It provides a connected PC with network settings so that the web pages can be accessed immediately without manually changing network settings.

This means that this port must never be connected to an existing network. The port is slower than the one labeled **ETHERNET** and should only be used for configuring the primary network connection.

On the **UltraBase30+**, **LOCAL PC** is a USB-C port that supports Ethernet over USB. Connection to a PC is made using a USB cable. No configuration is required on the PC.

On other UltraBase devices, **LOCAL PC** is an RJ-45 Ethernet connector.

UltraBase30+

- **10/100**: Lights yellow when connected at 10 Mbit/s. Lights green when connected at 100 Mbit/s. Blinks during activity.
- **1000**: Lights green when connected at 1000 Mbit/s. Blinks during activity.

Other UltraBase Devices

These have two LEDs per port. **LINK** lights yellow when the unit is connected to a network, and **LAN** blinks green when there is network communication.

6.4 Login and Password

UltraBase30+

The username and password for the standard users **view**, **operator**, and **config** are printed on a label on the back of the device.

UltraBase20, UltraBase30, and UltraBase40

User name	Password	User level
view	ab12	View
operator	cd34	Operator
config	ef56	Configurator

For each user, there is a possibility to configure automatic logout if the user has been inactive for a specified time. This setting is found under **Users**.

6.4.1 Warnings when logging in

When connecting to the device, you may receive warnings in the web browser about an insecure connection or similar messages. Verify that the IP address you are connecting to is correct and accept the warning.

To avoid browser warnings about an insecure connection, the **Abelko Innovation root certificate** can be downloaded and installed on the computer. The certificate must be imported into Windows, or alternatively into the Firefox browser. See: abelko.se/nedladdningar/.

Change the password to keep the system as secure as possible. Go to **System** and **Users**. Here you can change passwords for existing users and also add new users.

Under the **Communication** and **Network** menu, you can change the network settings.

6.5 Overview User Interface

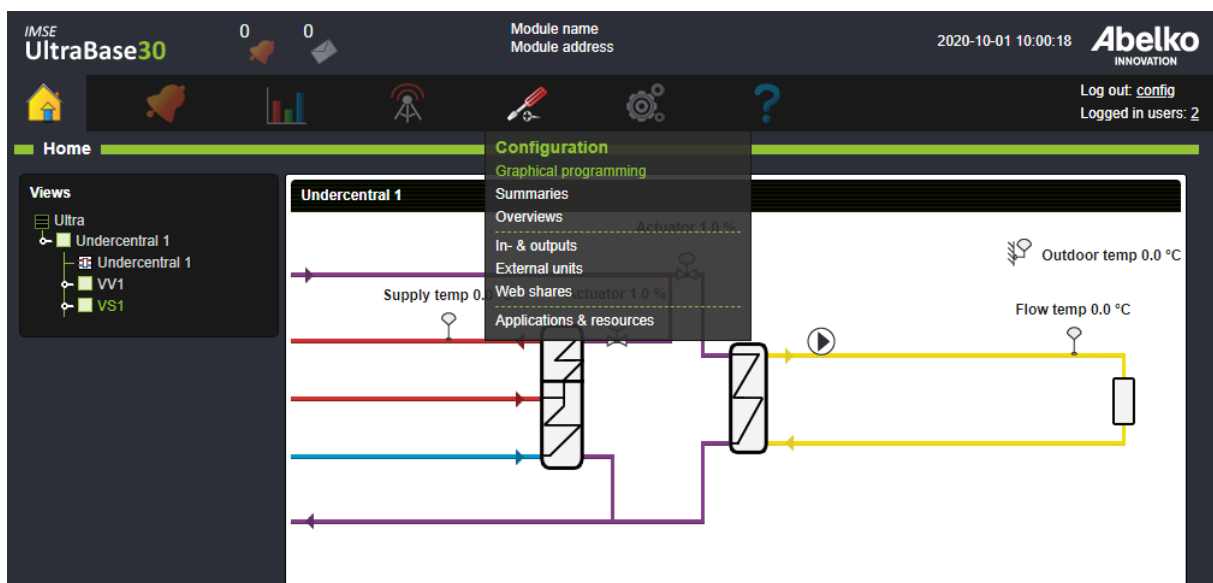

The **graphical programming** tool must be installed on your computer. Links can be found under the **Configuration** menu. Here you can configure substation and ventilation controllers, generate PID controllers and create applications with both graphical programming and script programming.

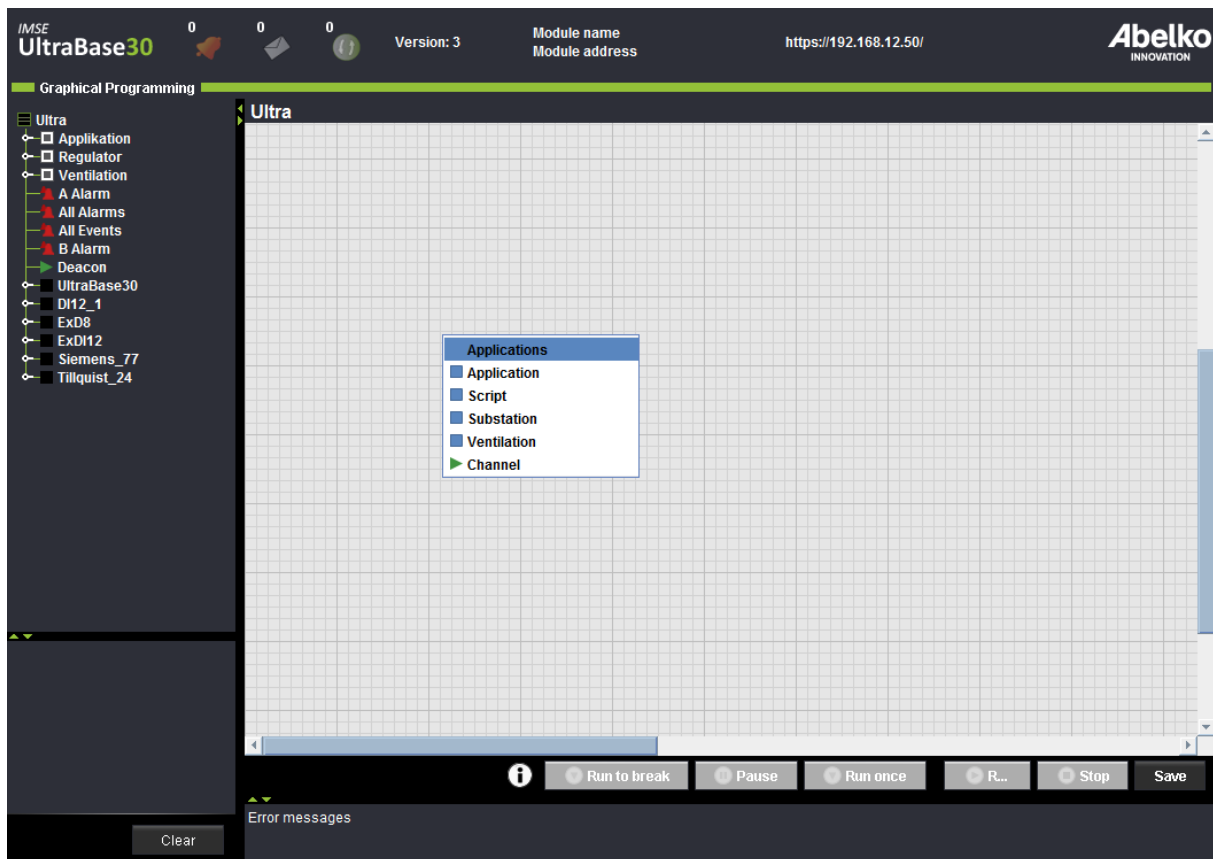

1. **Right-click** on the workspace and select the type of application you want to create. Substation, ventilation and PID take you to the controller tool.
2. Add the controllers and applications you want to use.
3. Open an application by **double-clicking** on it. **Right-click** on the workspace inside an application to add components and resources.
4. Click **Save** down to the right.

To understand how all the inputs, outputs etc. belong together, you may view the **node tree** (located to the left). The node tree contains all the elements in the system, arranged in hierarchical order. If you open an application, you can see what is in it, and further, if you fold out a subapplication, you can see what is in the subapplication.

Read more about the graphical programming in chapter Graphical Programming.

Create **Summaries** and **Overviews** for a detailed overview of the system. These tools are also located under the menu **Configuration menu**.

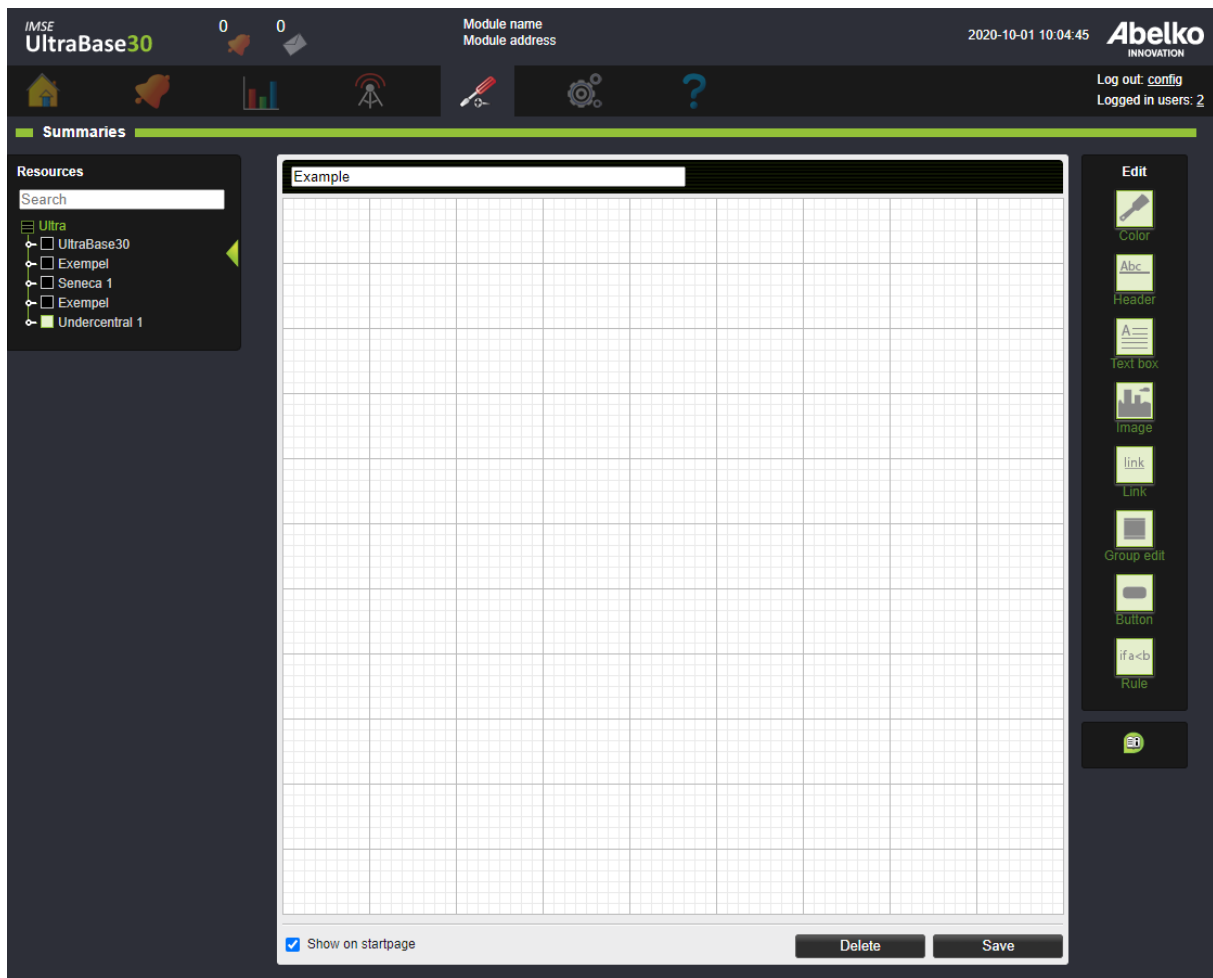

A **Summary** is a menu page you create for an installation. Add settings in terms of parameters, curves and time schedules, and information such as values from channels, alarms, text, links to overviews, and other summaries, and more.

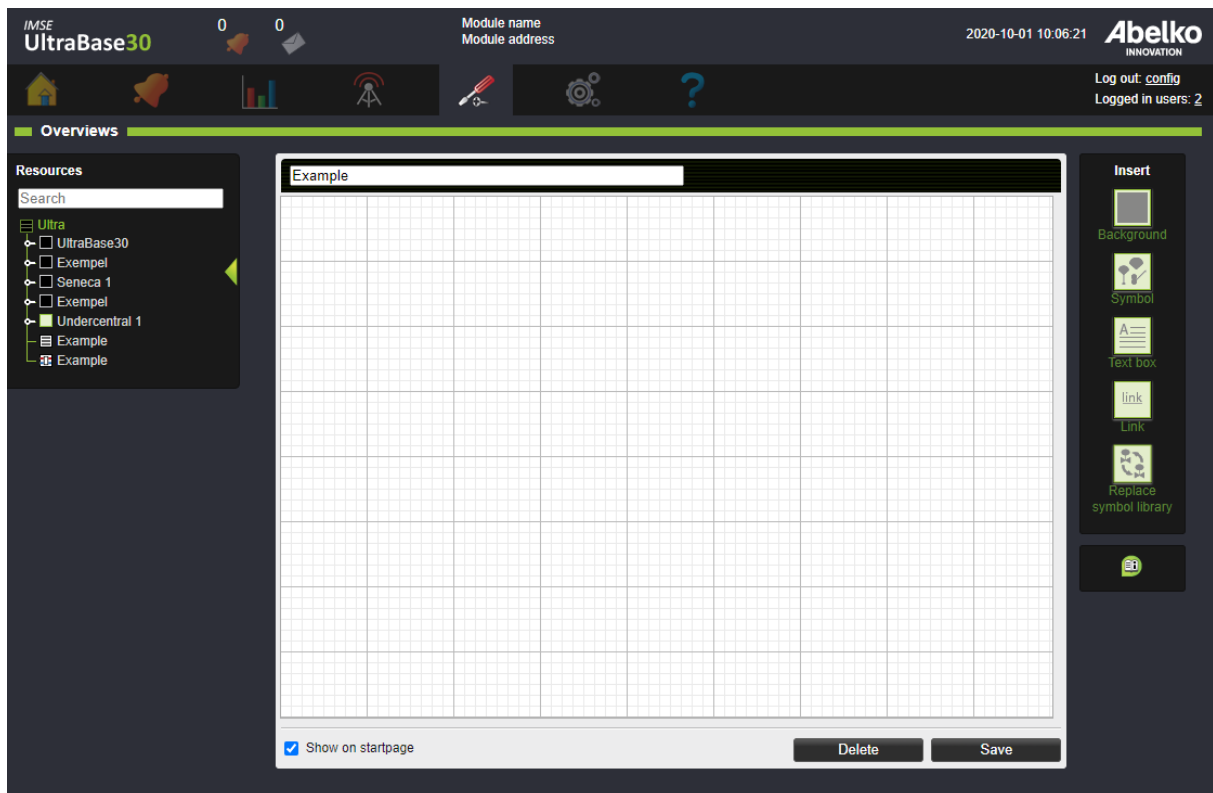

Overviews are pictures with live measurement values and settings you create to present a quick overview of the plant status. Drag and drop resources from the node tree on the left onto the workspace to add them. If you wish to use pictures for the overview, upload them by the page **System** and **File manager**. When you have finished creating overviews and summaries, they will be available at the **home page**.

If you need to change settings later or get an overview of applications, resources, inputs and outputs, external units and more, go to the menus located under the graphical programming.

Go to menu **In- & outputs** to configure inputs and outputs of the Ultra and IMSE Ex-expansions modules. Go to menu **External units** to configure other types of connected units, such as Modbus or M-bus devices. Under menu **Web shares**, you can configure communication with WMSHare.

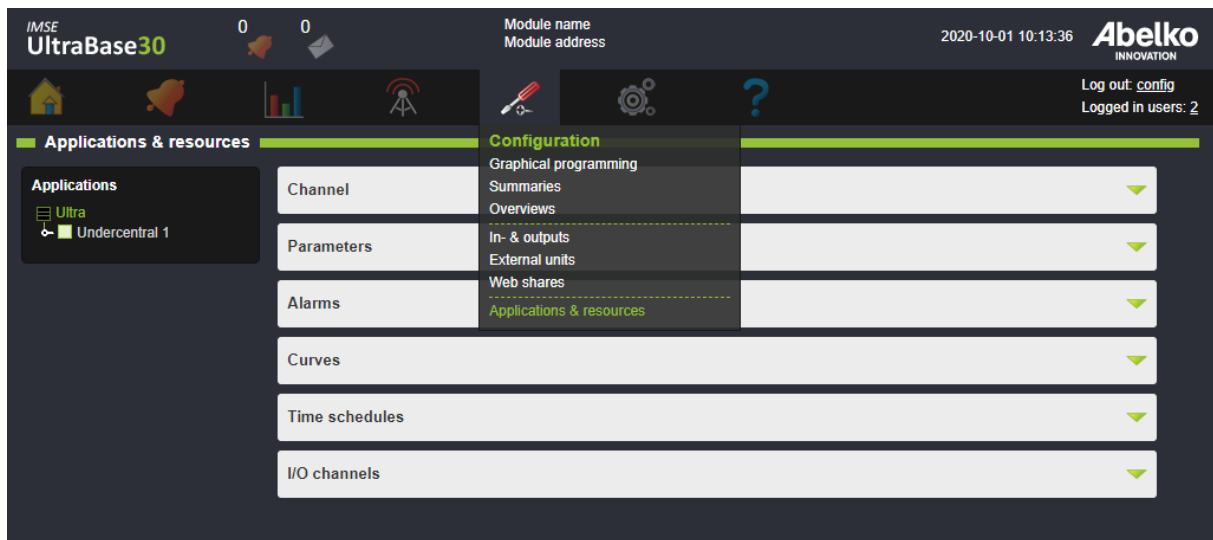

Under menu **Applications & resources**, you can see and edit settings for all the resources created in the unit. You can select an application in the node tree to the left to filter resources that belong to that application, and use the filter function above the table to search for resources with a certain name. Use this menu to access resources not included in a summary or an overview, or to get an overview of everything available in the unit.

There are four buttons in the interface:



The bell indicates if there are any active alarms in the system, the icon with multiple bells indicates if there are any active alarms for any companions and the letter shows if there are any new notes. The hand indicates that there are manually overridden channels. By clicking on these, you will be directed to more detailed information.

This was a short overview of the system. For more detailed information see the relevant chapter.

6.6 Connect Expansion Modules

Expansion modules are connected with a modular cable from **Ex OUT** on UltraBase. These are configured through the web interface under the menu **Configuration** and **In- & outputs**; read more about this in chapter **In- & Outputs**.

Keep in mind that if the system is preconfigured before the installation, it is important that the expansion modules are placed in the same order as configured for.

7 Applications & Resources

The unit's function is built up by applications and resources created in the Graphical programming tool. In this chapter we will explain what an application is and what types of resources are available in an Ultra. Under the menu **Configuration** and **Applications & resources** you can find an overview of the system's parts and also edit them.

7.1 Applications



An **application** is a box which contains a composition of functions. It is in the application that you will decide which features all channels, alarms, parameters and more will have and how they will work together.

Applications are created in the graphical programming, which in turn creates the underlying script. A tool has been added to help you to create substation, ventilation and PID controllers. Channels and I/O channels can also be configured for manual override, allowing a user to temporarily force the channel to have a different value than the system or application provides.

Channels can also be in- and output channels for an application, and become a way to connect an application with physical in- and outputs or other applications.

7.2 Channels



Channels handle all the variable data in the unit. I/O channels are connected to physical inputs and outputs and have scale factors for sensors and actuators. Ordinary internal channels handle calculating values. Channels can be monitored by alarms, and their values can be logged. Channels and IO-channels can also be configured for manual override, so that a user can temporarily override the channel to a different value than the one provided from the system or application.

Channels can also be input och output channels for an application, and become a way to connect an application to physical inputs or outputs or other applications.

7.3 Alarms



An **alarm** monitors the channel value according to set conditions and limits and is always created based on the channel. **A-alarm** has a red indicator and **B-alarm** has a yellow indicator.

In addition to the **A- and B-alarms**, you can assign an alarm a priority from **C-Z** (blue indication). You can also specify settings for acknowledgment and resetting an alarm.

Acknowledgment is a receipt that you have received and acknowledged the alarm by filling in your name. This is stored in the **Alarm history**, which is a list of all alarms and events status changes.

7.4 Alarm Groups



Alarm groups simplify managing alarm sendouts and allow creation of features for multiple alarms at the same time. You can select individual alarms or alarms of a specific priority.

7.5 Parameters



A **parameter** is a value that is named and set by the user. When you use the controller tool, parameters will be automatically created, including set points that you can edit later.

7.6 Curves

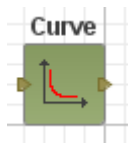

A **curve** is an interpolation table presented as a configurable curve. Curves are used by controllers to do things like converting an outdoor temperature into a flow temperature and can be monitored by the user both graphically and numerically. They can be edited by users both graphically and with numbers in tabular form.

7.7 Time Schedule



A **time schedule** is used to set times when things should be active or inactive. You can add rules which can be repeated weekly, monthly, yearly or with a free adjustable interval. You can also choose not to repeat the rule and only set times for a specific date.

8 Graphical Programming

In this chapter you will learn how to use the graphical programming. At the end of this chapter there is an overview of all the icons and their functions.

The graphical programming is located under the **Configuration** menu.

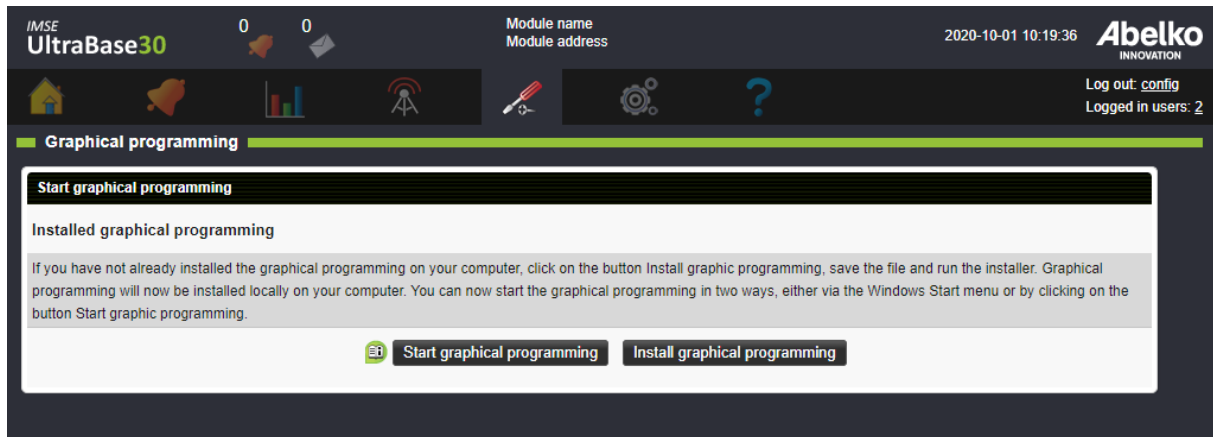

If you have not already installed the graphical programming on your computer, click on the button **Install graphic programming**, save the file and run the installer. Graphical programming will now be installed locally on your computer. You can now start the graphical programming in two ways, either via the Windows Start menu or by clicking on the button **Start graphic programming**.

You work with different levels in the graphical programming. On the top level you create head applications, which can be started and stopped independently. It is here you connect the physical inputs and outputs. Inside of these head applications, you have sublevels where you create subapplications. It is here you add components.

8.1 Create Substation and Ventilation Controllers

Create controllers is a wizard style tool in the graphical programming that helps you to create controllers quick and easy.

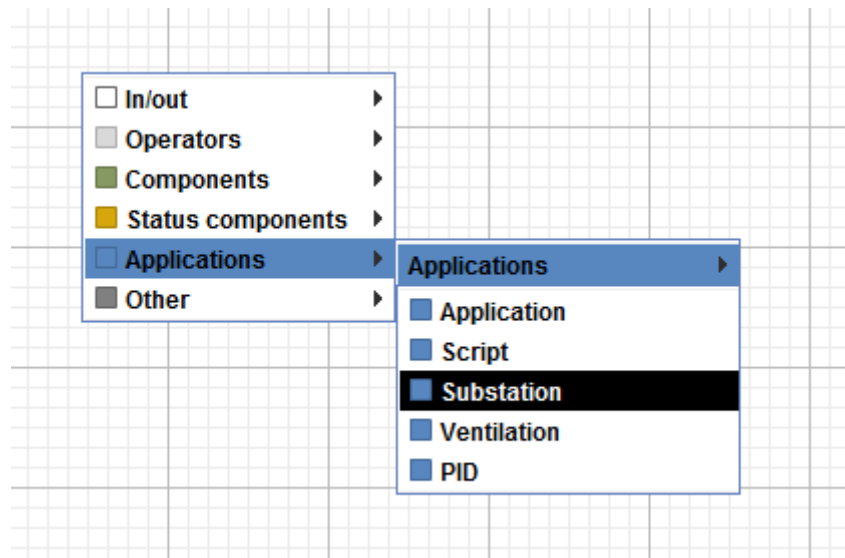

1. **Right-click** on the workspace and open menu **Applications**. Choose what type you want to create (**substation, ventilation** or **PID** controller).

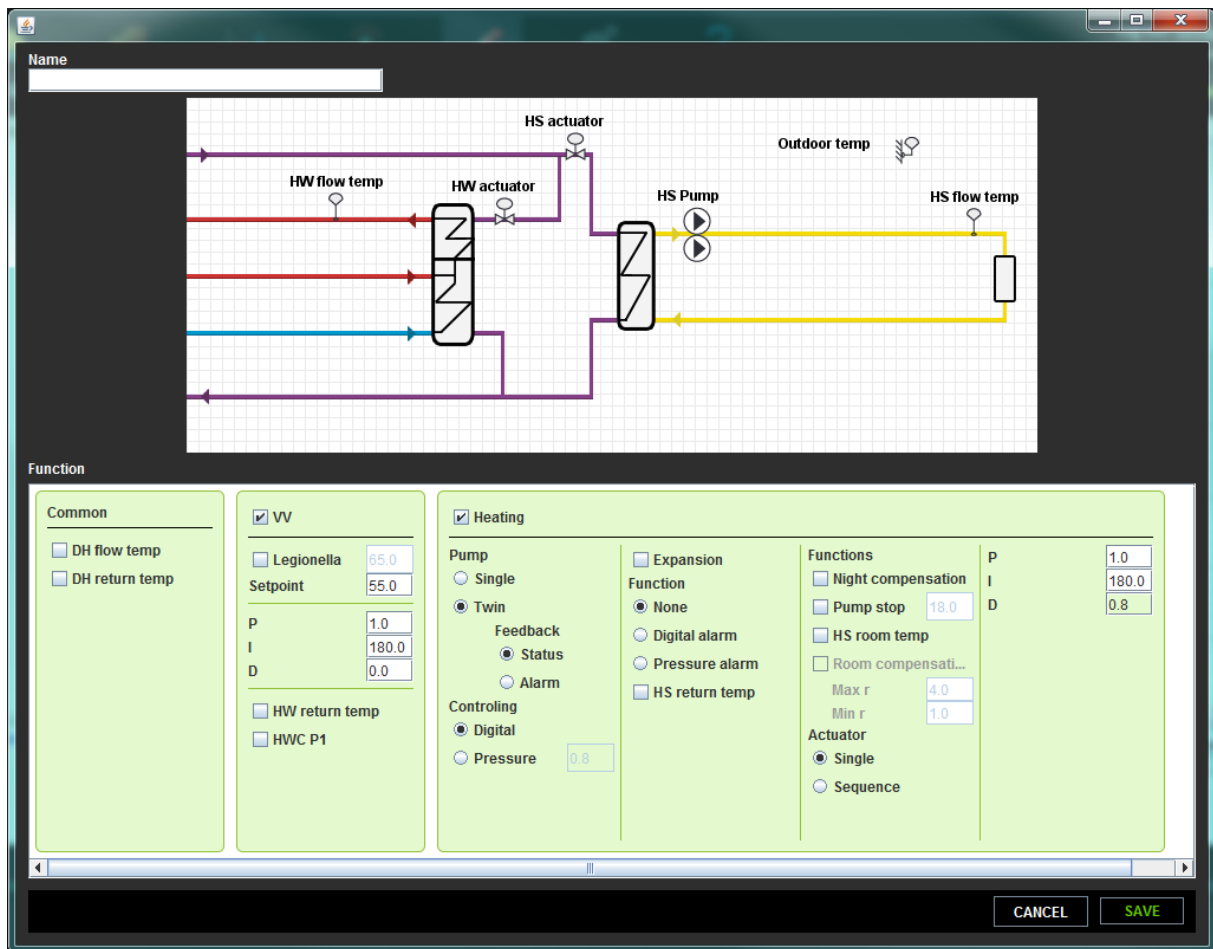

2. Choose what functions you want to have in the system in the new window. Don't forget to **name** the controller.
3. Click **Save**. A graphical programming will be created where you can make adjustments. The controller tool will also generate an overview and a summary for the web interface.
4. Verify that the generated application is working as you intended.

8.2 Create Graphical Programs

In order to build a system you need to create applications. These will contain all the components, which in their turn creates a system with different functions.

1. To create an application **right-click** on the workspace and choose **Application** in the menu.
2. **Double-click** on an application to enter. In this menu you can create subapplications and add resources and components by **right-clicking** on the workspace.

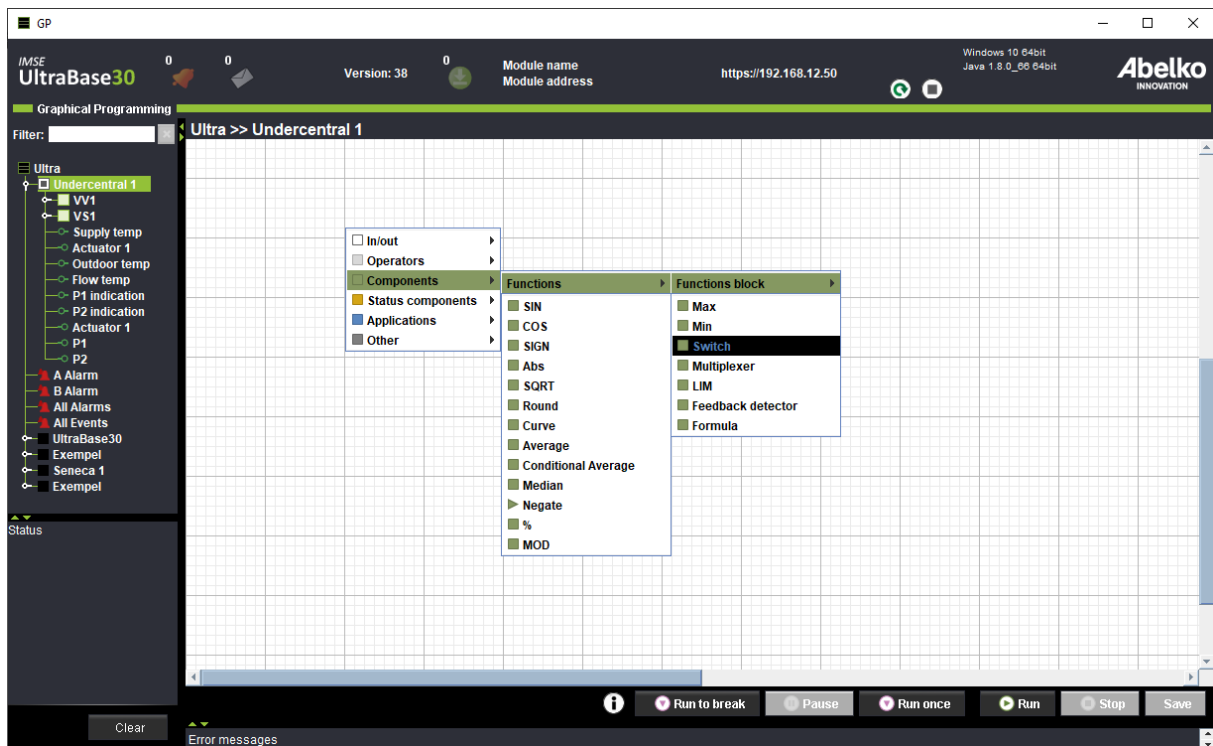

3. **Drag-and-drop** channels, parameters and more from the node tree to the left onto the workspace to add them.
4. Connect the resources and components.

Note! Before an application is ready to be used, it needs to be saved and to be **runnable**. For it to be **runnable**, all the components in the application and all subapplications need to be connected to each other so it can create a syntactically correct script. The text box down to the left gives information about the script. Expand the information window below the main window to see more detailed information. If it is not **runnable**, the main application box will turn grey and have an exclamation mark.

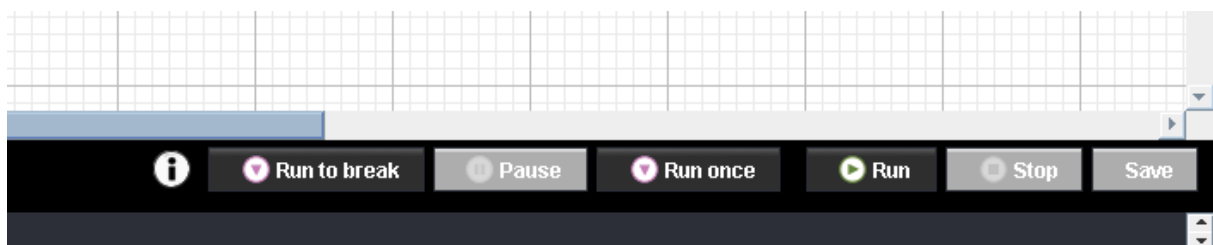

5. You can use one of the debug states if you want to test a script for an application. Mark the application and use the buttons down to the right (**Run to breakpoint**, **Pause** or **Run once**). Breakpoints only works when you create applications in the script editor. The head application will turn pink and a pink symbol will appear. Breakpoints in the script will be ignored when the application is not in the debug state.
6. To run the application, select it and press **Run** at the bottom right. It will turn green and a play icon will appear. If editing a running application, you must first stop the application before saving it.
7. To change to settings or create a template, **right-click** on the application. To delete an application, right-click on it in the tree menu, and select delete.
8. Do not forget to **save** at the bottom right of the page. The applications that you have made changes to will have a dashed frame around the name in the node tree so it is easy for you to see which ones that needs to be saved. Changes made at the top level are automatically saved as they are made.

Example: create a lighting control

In this example, we want to control an outdoor lighting. We start with creating a new application and call it Lighting control.



With a parameter, we will be able to choose how it should be controlled. Right click, create a parameter, and name it Function selection. Under optional settings choose **Formatting type Named list**.

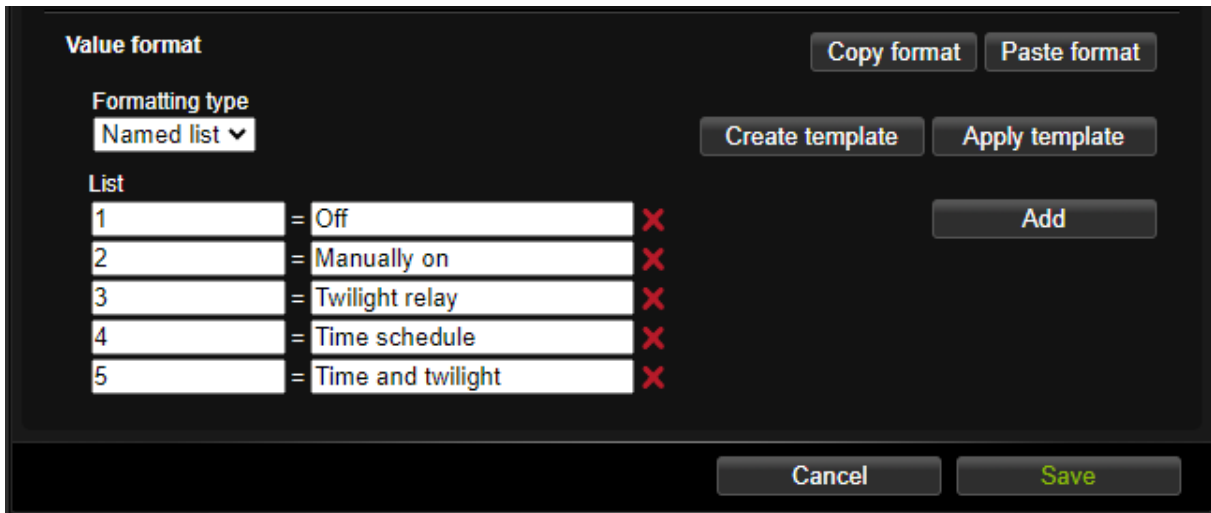

We create a list with:

1 = *Off*

2 = *Manually on*

3 = *Twilight relay*

4 = *Time schedule*

5 = *Time and twilight*

We right-click and select the **multiplexer** component from **Components / Functions block**. When the component is selected, it has an arrow symbol at the bottom. By clicking the arrow and pulling it down we can extend the multiplexer so we have five inputs in addition to the top control input. We connect the parameter to the control input so it can select its functioning. The inputs are numbered from the top so the first input corresponds to manually off and should therefore be zero. We create a constant from the **In/Out** menu by right-clicking, set the value to zero and connect it to the first input.

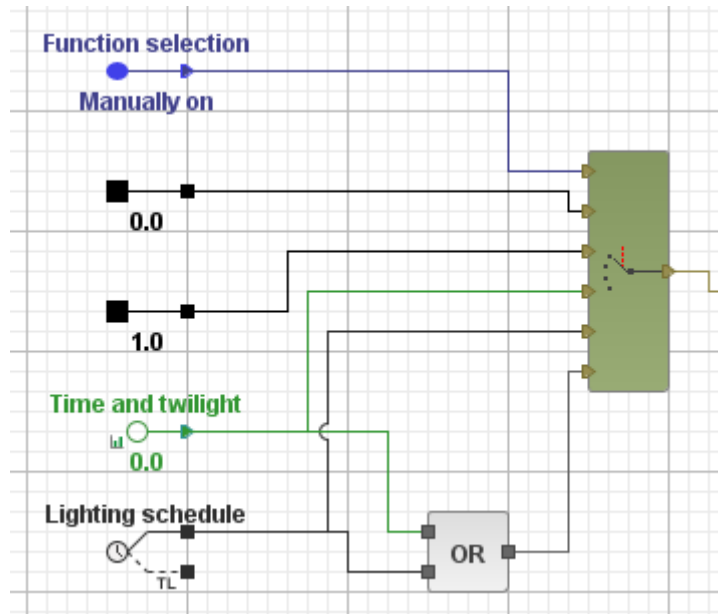

The next number should be for *Manually on*, and then we create an in channel for the twilight relay and create a time schedule.

Edit time schedule ✖

Name: Active Current status: Off

Add:

November 2023

	1	2	3	4	5
6	7	8	9	10	11
13	14	15	16	17	18
20	21	22	23	24	25
27	28	29	30		

Mon	Tue	Wed	Thu	Fri	Sat	Sun
01	03	05	07	09	11	13
15	17	19	21	23		

Active	Type	Rule type	Period	Edit	Delete	Status
<input checked="" type="checkbox"/>	On	Weekly	Monday,Tuesday,Wednesday,Thursday,Friday,Saturday,Sunday 20:00:00 - 23:59:59		✖	<input type="radio"/>
<input checked="" type="checkbox"/>	On	Weekly	Monday,Tuesday,Wednesday,Thursday,Friday,Saturday,Sunday 00:00:00 - 08:00:00		✖	<input type="radio"/>

▼ Holiday catalog: None

We create the last alternative Time and twilight by connecting the twilight relay with the time schedule with an **OR**-function located under **Operators**.

Another feature we want to add in the lighting control is a button that turns on the lights and then turns them off automatically after a predetermined time.

First, we create an in channel for the button and a parameter for the set time. If we choose to set the time in minutes, we need to multiply it by 60 to get seconds. We connect these two to a TIMER-component. The T-input states time and the R-input is a reset input. The components act as a stove timer. When r is one, the timer is turned on, and the outcome is one. When r gets low, the timer is released and starts the countdown. When r becomes zero, the output becomes zero.

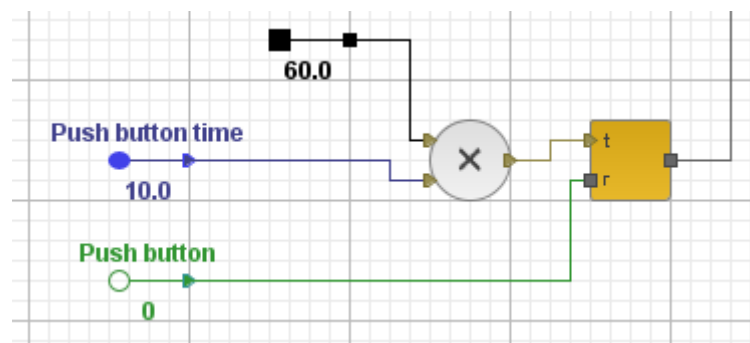

The multiplexers and the timers' outputs are connected to an OR-function and continue to an out channel that will control the light.

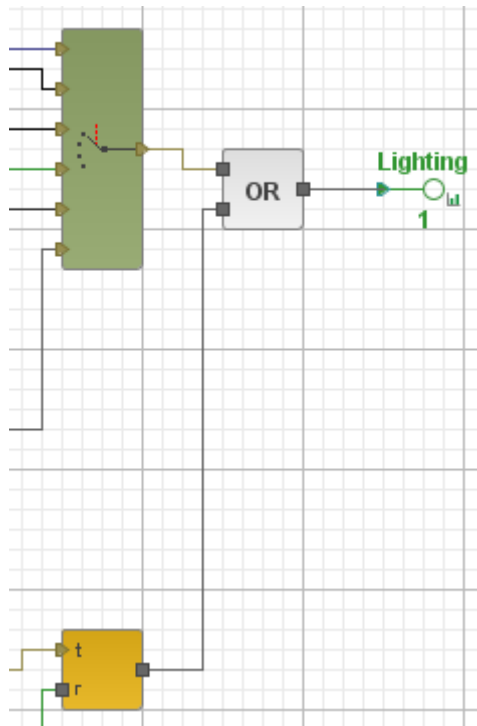

The lighting control is now complete and ready to be used.

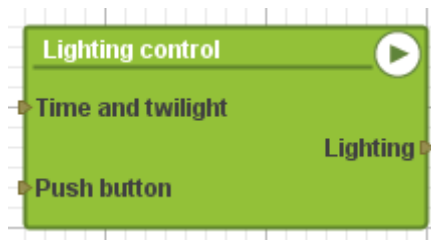

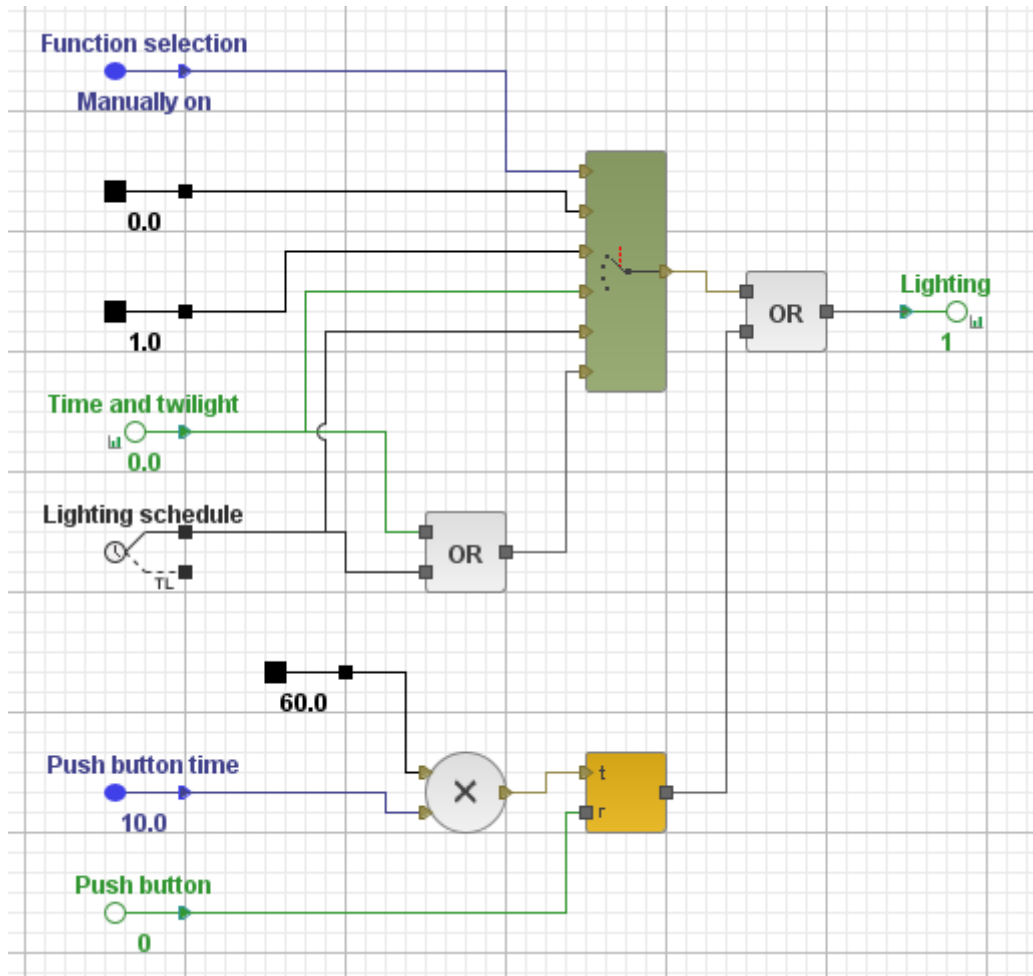

This is what the finished graphical programming and application looks like.

By saving and pressing **Run**, you can start the application and test how it works. Right-click on the parameter **Function selection** to change settings. With a little delay, you can see in the schematic how the output signal changes. Before the in-channels are connected to any inputs on a higher level in the graphical programming, you can set the values to see what's happening.

Application types

Applications (main applications, have a status symbol, located on the top level in the node tree).



Subapplications (have no status, located under an application in the node tree).

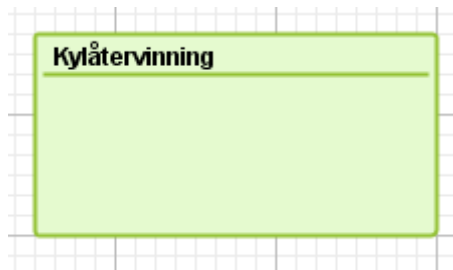

Script applications (marked with a notepad)

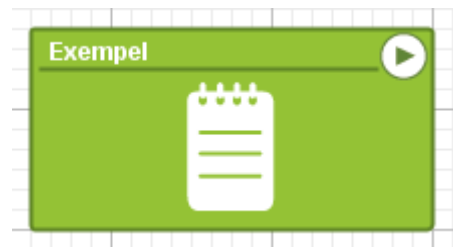

8.2.1 Create a Template of an application

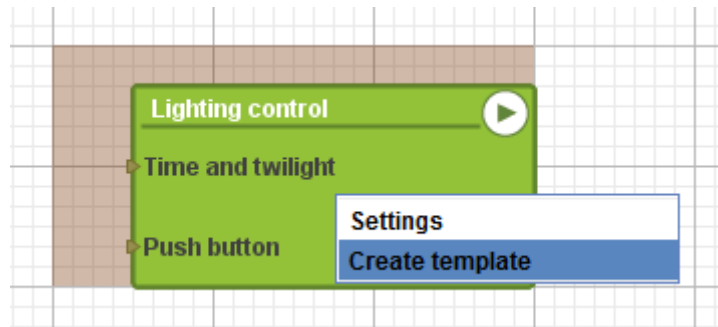

1. **Right-click** on an application and choose **Create template**. A template is a snapshot of how that application looks at the time it was taken.

A screenshot of the 'Create template' dialog box in the 'Ventilation' application. The dialog has a title bar with 'Ventilation' and a close button. The main area is dark with a white header 'Create template'. Below the header are two input fields: 'Name' and 'Description'. At the bottom are two buttons: 'Cancel' and 'Create'.

2. Name the template and add or change the description.
3. Click Save.

The template will be available when you create a new application. If you choose to use the template, the new application will be a copy of the old application including overviews and summaries.

Note! Holiday catalogs are not included in Application Templates.

If you want to change a template, you first need to create an application based on that template, make the changes and then save it as a new template.

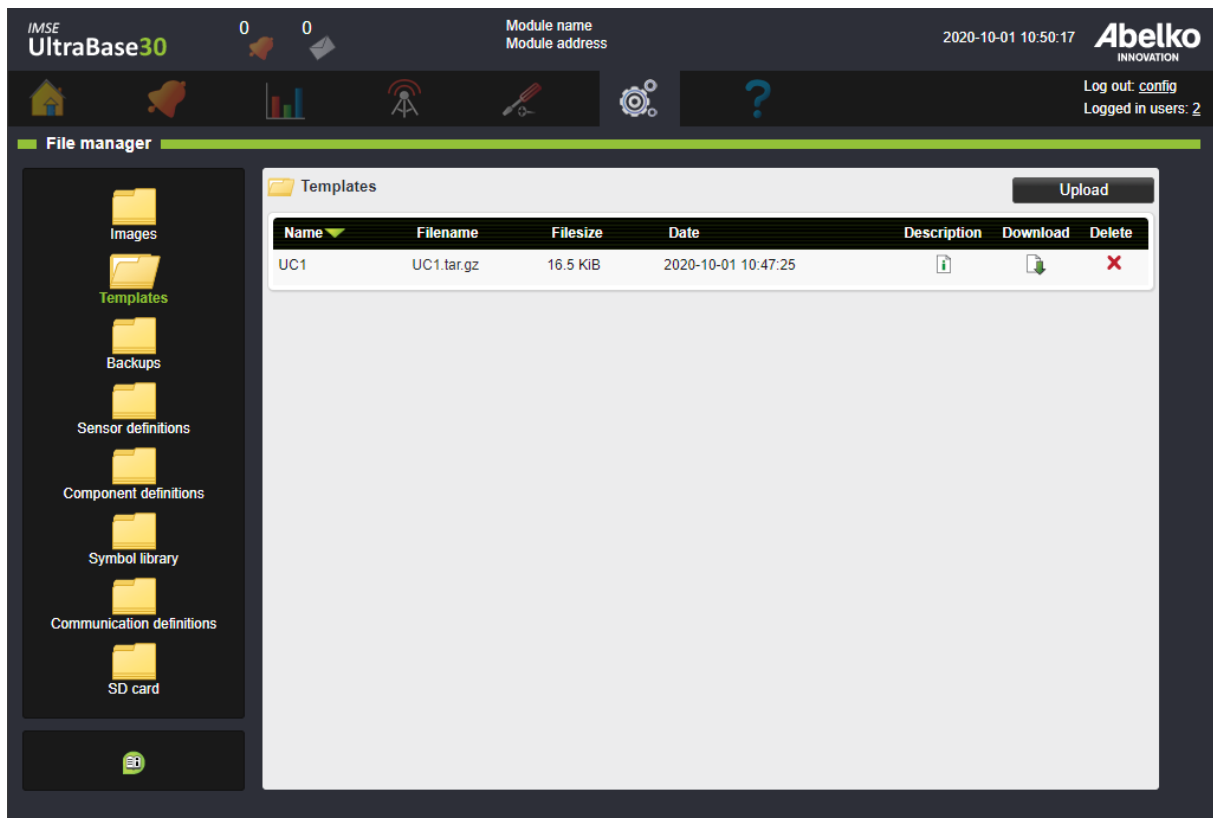

In the browser, under **System** and **File manager**, you can see the templates you have in the **Templates** folder. Here you can download templates to your computer, and upload templates from your computer to your Ultra. The templates in the folder will be available when you create a new application in the graphical programming.

8.2.2 Application backups

The screenshot shows the 'Backups' section of the UltraBase30 web interface. It is divided into two main parts: 'Application backups' and 'System backups'.

Application backups: This section contains a table with the following data:

Name	Description	Date	Delete	Export	Restore
2016-12-19		2016-12-19 10:15:23	X		
FactoryDefaults		2015-11-12 10:10:23	X		

System backups: This section includes a form for 'Automatic backup to SD-card' with the following settings:

- Periodically: Never
- Time: 00:00
- Day: Monday

The 'Automatic backups are disabled' message is visible. Below the form is a table of system backups:

Name	Date	Delete	Export	Restore
ultraBaseBackup_00000186_20150409_090054.tar.gz	2015-04-09 09:45:24	X		
ultraBaseBackup_00000186_20150415_130010.tar.gz	2015-04-15 13:15:26	X		
ultraBaseBackup_00000186_20150415_131557.tar.gz	2015-04-15 13:23:54	X		

Backups can be found under the **System** menu. Here you have both **Application backups** and **System backups**. Application backups can be used to go back to a configuration that worked before you made changes or if you want to create a new identical device. An application backup includes graphical programming, overviews, summaries, in- and outputs, external units, and more. **Not** included is logged data, alarm history, notes and network settings.

Create a new application backup

1. Click **Create new**.
2. Name the backup and add a short description.
3. Click **Create new**.

The backup is now saved in the system and placed in the list of existing application backups.

All backups are also available under the menu System and File manager in the Backups folder. There you can download an application backup to your computer or upload a previously saved backup to make a copy of an application.

Note! This section refers to creating an application backup. To create a full backup of the systems data see section Backups.

8.3 Channels

1. Create a channel by **right-clicking** on the workspace in the graphical programming and select **Channel** from the menu. Edit the channel and click **Save**. The channel will now be on the workspace.

The screenshot shows a 'New channel' dialog box with the following fields and sections:

- Name:** An empty text input field.
- Value:** A text input field containing the number '0'.
- Decimals:** A text input field containing the number '1'.
- Unit:** An empty text input field.
- Log settings:** A section with four columns: 'Status', 'Type', 'Interval', and 'Offset'. An 'Add' button is located to the right of this section.
- Optional settings:** A section with a dropdown arrow and the text 'Optional settings'.
- Buttons:** 'Cancel' and 'Save' buttons are located at the bottom of the dialog.

2. Connect a channel by dragging and dropping the arrow to the resource you want to connect it with. You can control how the value will be used with help by the arrows. The left arrow will connects in to the channel, and the right arrow connects out from the channel. You cannot use both from the same channel, but you can place two symbols of the same channel on the workspace.

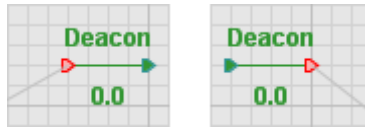

When you connect channels with an application, the channels will merge with the application in order to make room for more channels.

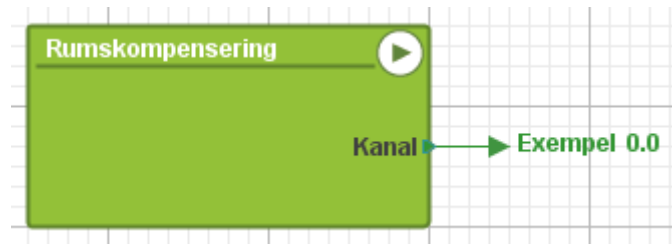

By moving a channel away from the application, it will return to normal mode so that you can connect the channel with more than one resource.

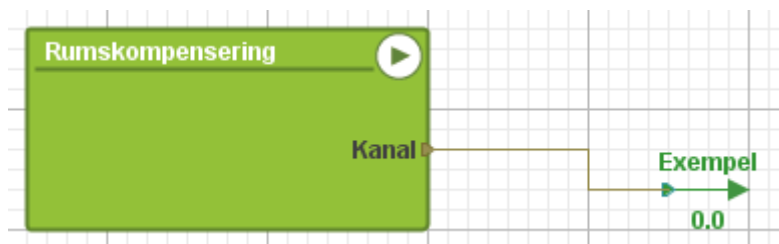

Value formatting

Under **Optional settings** you can choose to format the channel according to different types.

Normal The value of the channel is displayed according to the number of decimals you selected.

Float Displays the value with the decimals needed. If you select Scientific the number is presented as e.g. 1E6.

Fixed You select the width of the channel, the number of digits to be displayed. You can also select decimal or hexadecimal.

Pick list Shows only the values you listed yourself.

Named list Displays values as the name you selected for them. A Named list can be saved as a template to be used for other channels on the same Ultra, or on another Ultra. Templates are uploaded and downloaded under *File manager/Templates/Templates Named list*. It is also possible to copy the format of a Named list to paste it to another channel on the same Ultra.

Channel types, top level

↔ **IO-Channels** IO-Channels represents data input from an IO, an expansion module or an external unit, or data or settings that are outputs.

Channel types, applications

▶ **Channel** Handles changing data inside an application. A channel can be monitored with an alarm, and can be logged. Channel data can be presented on overview and summary web pages. Channels can also be created and used at top level.

↔ **In channel** When you create an in channel in an application, you create an input to application symbol one level up.

↔ **Out channel** When you create an out channel in an application, you create an output on the application symbol one level up.

If you drag and drop an I/O channel into an application, an in- or output channel is created in the application that automatically connects to the I/O channel at the levels above.

8.3.1 Channel logs

1. **Right-click** on a channel and select **Settings**.

New channel

Name

Value: 0 Decimals: 1 Unit:

Log settings

Status	Type	Interval	Offset

Optional settings

Cancel Save

2. Click on **Add** to add a log. You can have different types of logs for the same channel.
3. Choose **type** of log, set **range** and **offset**.
4. Click **Save**.

See more about the different types of logs in chapter Types of logs.

8.4 Alarms



1. To create a new alarm in the graphical programming, **right click** on a channel in the node tree or in the workspace and select **Alarm**.

Edit alarm

Channel: Control error - Name: LARM_REGLERFEL Change channel name

Priority: A

Condition: Outside (limit 1 > value > limit 2) Limit 1: -10 Limit 2: 10

Hysteresis: 1

Filter on: 60 sec. Filter off: 60 sec.

Acknowledgement type: Automatic reset, no acknowledgement

Alarm message: Message_Alr66_JAKV

Buttons: Cancel, Save

2. Under settings, you can change the name of the alarm, see which channel it belongs to, and change the priority and alarm limits.

The different **priorities** are:

- **A-alarm** (red indication)
- **B-alarm** (yellow indication)
- In addition to these, an alarm can have the priority **C-Z** (blue indicator)

The different **conditions** are:

- **Equals (value = limit 1)**: the alarm is activated when the value is exactly the same as the value entered under Limit 1.
- **Greater than (value > limit 1)**: the alarm is activated when the value is greater than the value entered under Limit 1.
- **Less than (value < limit 1)**: the alarm is activated when the value is less than the value entered under Limit 1.

- **Greater ($\text{abs}(\text{value}) > \text{limit 1}$):** the alarm is activated when the value is greater than the value entered under Limit 1 without taking into account whether the value is positive or negative.
- **Smaller ($\text{abs}(\text{value}) < \text{limit 1}$):** the alarm is activated when the value is smaller than the value entered under Limit 1 without taking into account whether the value is positive or negative.
- **Between ($\text{limit 1} < \text{value} < \text{limit 2}$):** the alarm is activated when the value is between the values entered under Limit 1 and Limit 2.
- **Outside ($\text{limit 1} > \text{value} > \text{limit 2}$):** the alarm is activated when the value is below the value entered under limit 1 or above the value under Limit 2.

The **Hysteresis** settings prevent the alarm from repeatedly switching between active and inactive when the value is equal to the limit. It specifies the number of degrees by which the value must fall back below the limit or limits before the alarm can be cleared.

The **On-filter** specifies the number of consecutive seconds the alarm condition must be true before the alarm is triggered. The **Off-filter** specifies the number of consecutive seconds the alarm condition must be false before the alarm is cleared.

The different **acknowledgments** are:

- **Reset when acknowledged:** the alarm remains active until a user acknowledges it. If the error remains after the alarm is acknowledged, it will remain active until the error is cleared, including the delay and hysteresis.
- **Automatic reset, with acknowledgment:** the alarm reset itself when the error is cleared, but it still has to be acknowledged. In this case, the acknowledgment is a kind of confirmation that someone has noticed the alarm. Details of the reset and the acknowledgment are both recorded in the alarm history.
- **Automatic reset, without acknowledgment:** there is no need for a user to acknowledge the alarm. The alarm is cleared when the error is no longer active as defined in the alarm conditions. You can specify delay and hysteresis values in the condition.

8.5 Alarm Groups



Alarm groups simplify managing alarm sendouts and allow creation of features for multiple alarms at the same time. For example, in the graphical programming you can use an alarm group that contains all **A-alarms** instead of working with all of the **A-alarms** one by one.

1. **Right-click** on the workspace when you are inside of an application; select menu **In/out** and choose **Alarm group**.
2. Name the alarm group.

New alarm group ✕

Name Application Ultra

Language
Swedish ▾

Type
Standard mail format for Comprobo ▾

Alarm priorities

A B

C D E F G H I J K L M

N O P Q R S T U V W X

Y Z

Application	Channel - Alarm	Priority
<input type="checkbox"/> Undercentral 1.VV1	Control error - LARM_VVC_REGLERFEL	B
<input type="checkbox"/> Undercentral 1.VS1	Control error - LARM_REGLERFEL	A
<input type="checkbox"/> Undercentral 1.VS1	P1 running error - P1 running error alarm	None
<input type="checkbox"/> Undercentral 1.VS1	P2 running error - P2 running error alarm	None

3. Select which alarms you want in the alarm group by clicking the box next to the alarms. You can only choose alarms from the application and its subapplication that you have selected.
4. For example, if you would like to add all **A-alarms** from that application, click the box next to the **A**. By doing this, all future **A-alarms** created in the application will be included in the alarm group.
5. Click Save.

Email settings for sendouts are configured under the menu **Data, Alarm sendouts** in the web interface.

8.6 Curves

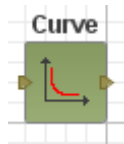

Curves are used to convert or compensate values.

1. Right click on the work space and select curve.

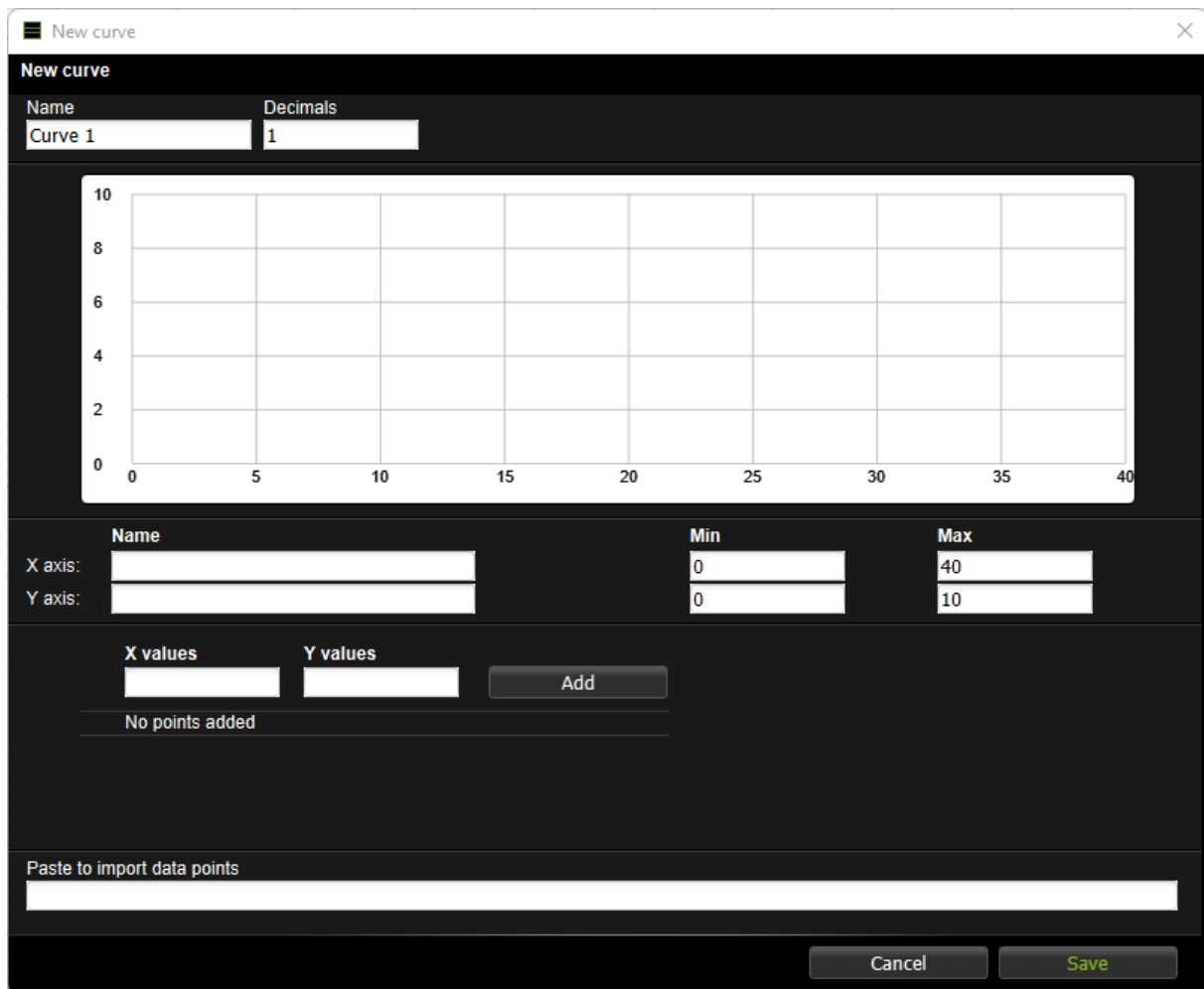

2. Set a name for the curve
3. Select the **number of decimals** you want the data points to have.
4. Choose **min** and **max** values for X- and Y-axis.
5. You can now start to add data points by **double-clicking in the graph** and adjust them by moving them around. You can erase a point by **double-clicking** on it.
6. You can also add and edit data points in the table under the graph. If you have a text file, you can paste it in the window **Paste to import data points**.
7. Click **Save**.

Example: a curve for room compensation

If you want to have a compensation from the room temperature in a controller, creating a curve is a good and easy way to set the compensation level.



The picture shows a curve with +3K compensation at 15°C with no compensation between 19-21°C and -10K at 30°C.

Connecting the curve to a room sensor is done in the graphical programming.

8.7 Parameters



Parameters are used to store values that can be changed by a user. You use these to set values, which in their turn control other parts of the plant.

1. **Right-click** on the workspace when inside an application; select menu **In/Out** and click Parameter.

The screenshot shows a 'New parameter' dialog box with the following fields and options:

- Name:** An empty text input field.
- Value:** A text input field containing the number '0'.
- Decimals:** A text input field containing the number '1'.
- Unit:** An empty text input field.
- Log settings:** A section containing a table with columns 'Status', 'Type', 'Interval', and 'Offset'. An 'Add' button is located to the right of this table.
- Optional settings:** A section with a dropdown arrow icon.
- Buttons:** 'Cancel' and 'Save' buttons are located at the bottom right of the dialog.

2. Name the parameter. Enter a value, number of decimals and a unit. You can choose if you want to log the parameter. Add a new log to the list by clicking on **Add**.
3. You can change the **value format** under **Optional settings**. For example, you can specify that you can only select listed values in a list (**Pick list**) or listed named values (**Named list**) as in the example in chapter Create Graphical Programs.

8.8 Time Schedules



A **time schedule** is used to set times when things should be active or inactive. You can create a time schedule and connect it to an object in the graphical programming. You can also choose if you want the time schedule to enable or disable an object (the red blocks always rule over the green blocks).

1. **Right-click** on the workspace when you are inside an application; select menu **In/Out** and click **Time schedule**.
2. Enter name, check the box **Active** and click **Save**.
3. Choose which type of rule you want to add: **Date, Weekly, Monthly, Yearly** or **Periodically**. We will explain the different types in the next section.
4. Under **Holiday catalog** you can choose to activate a holiday catalog which is uploaded via the **System > File Manager** page under the folder **Holiday catalogs**. You can see which dates the file contains along with a description and which day of the week the date will be counted as. **Holiday catalog** is only applicable to **Weekly** rules. This can be used if, for example, you have a regulation that the heat should be lowered on Sundays since the premises are not being used at that time, but that this should also apply to public holidays such as Christmas Eve that occurs on a weekday.

Keep in mind that all dates that are in the holiday catalog will be included in your rules which are **Weekly**, please double check that the correct rules are used in your weekly schedule.

Note! Holiday catalogs are not included in Application Templates.
5. When you added rules, you can see the time schedule's **status** on the top of the page. To **disable** a schedule uncheck the box to the left of its name. The time schedule will not become active until you select the box again.

8.8.1 Date

This is used when you want to do something on a specific date.

The screenshot shows a 'Date' configuration window with the following elements:

- Buttons: **On** (highlighted in green), **Off**, and **Active** (checkbox checked).
- Start** section:
 - Input fields: YYYY-MM-DD (2014-11-20), TT:MM:SS (07:42:00)
 - Calendar: November 2014, with the 20th highlighted.
- Stop** section:
 - Input fields: YYYY-MM-DD (2014-11-21), TT:MM:SS (07:42:00)
 - Calendar: November 2014, with the 21st highlighted.
- Bottom right: **Cancel** and **Save** buttons.

1. Select if you want the rule to enable (**On**) or disable (**Off**) objects.
2. Set start and stop time in the boxes **YYYY-MM-DD** and **TT:MM:SS**.
3. Mark the date in the calendar.

The rule will automatically be set to **Active**. You can **Inactivate** it by using the checkbox up in the corner. If you click **Cancel**, you will leave you the page without saving the changes you have made.

4. Click **Save**. The rule will now be included in the list on the overview page.

8.8.2 Weekly

This is used when you want something to be repeated every week.

1. Select if you want the rule to enable (**On**) or disable (**Off**) objects.

2. Set start and stop time by moving the bar in the time axis or type the time in the boxes.
3. Select the days the rule should apply to by clicking on the weekdays.

The rule will automatically be set to **Active**. You can **Inactivate** it by using the checkbox up in the corner. If you click **Cancel**, you will leave you the page without saving the changes you have made.

4. Click **Save**. The rule will now be included in the list on the overview page.

On the overview page, under **Holiday catalog**, you can choose to activate a holiday catalog which is uploaded via the **System > File Manager** page under the folder **Holiday catalogs**. You can see which dates the file contains along with a description and which day of the week the date will be counted as. **Holiday catalog** is only applicable to **Weekly** rules. This can be used if, for example, you have a regulation that the heat should be lowered on Sundays since the premises are not being used at that time, but that this should also apply to public holidays such as Christmas Eve that occurs on a weekday.

Keep in mind that all dates that are in the holiday catalog will be included in your **Weekly** rules, please double check that the correct rules are used in your weekly schedule.

Note! Holiday catalogs are not included in Application Templates.

8.8.3 Monthly

This is used when you want something to be repeated every month.

1. Select if you want the rule to enable (**On**) or disable (**Off**) objects.

The screenshot shows a configuration window titled "Monthly". At the top left, there are two buttons: "On" (highlighted in green) and "Off". At the top right, there is a checkbox labeled "Active" which is checked. Below these are two sections for time configuration. The first section is labeled "Start" and has a text input field containing "00:00:00" and a time axis bar below it. The time axis bar has 24 columns labeled from "00" to "24". A green bar is positioned at the "00" mark. The second section is labeled "Stop" and has a text input field containing "00:00:00" and a similar time axis bar with a green bar at the "00" mark. To the left of the time axes is a calendar grid with days numbered 1 through 31. At the bottom of the window are two buttons: "Cancel" and "Save".

2. Set start and stop time by moving the bar in the time axis or type the time in the boxes.
3. Mark the date in the calendar.

The rule will automatically be set to **Active**. You can **Inactivate** it by using the checkbox up in the corner. If you click **Cancel**, you will leave you the page without saving the changes you have made.

4. Click **Save**. The rule will now be included in the list on the overview page.

8.8.4 Yearly

This is used when you want something to be repeated yearly.

Yearly

Active

Start
00:00:00

00 01 02 03 04 05 06 07 08 09 10 11 12 13 14 15 16 17 18 19 20 21 22 23

January							February							March							April						
1	2	3	4	5	6	7	1	2	3	4	5	6	7	1	2	3	4	5	6	7	1	2	3	4	5	6	7
8	9	10	11	12	13	14	8	9	10	11	12	13	14	8	9	10	11	12	13	14	8	9	10	11	12	13	14
15	16	17	18	19	20	21	15	16	17	18	19	20	21	15	16	17	18	19	20	21	15	16	17	18	19	20	21
22	23	24	25	26	27	28	22	23	24	25	26	27	28	22	23	24	25	26	27	28	22	23	24	25	26	27	28
29	30	31					29							29	30	31					29	30					

May							June							July							August						
1	2	3	4	5	6	7	1	2	3	4	5	6	7	1	2	3	4	5	6	7	1	2	3	4	5	6	7
8	9	10	11	12	13	14	8	9	10	11	12	13	14	8	9	10	11	12	13	14	8	9	10	11	12	13	14
15	16	17	18	19	20	21	15	16	17	18	19	20	21	15	16	17	18	19	20	21	15	16	17	18	19	20	21
22	23	24	25	26	27	28	22	23	24	25	26	27	28	22	23	24	25	26	27	28	22	23	24	25	26	27	28
29	30	31					29	30						29	30	31					29	30	31				

September							October							November							December						
1	2	3	4	5	6	7	1	2	3	4	5	6	7	1	2	3	4	5	6	7	1	2	3	4	5	6	7
8	9	10	11	12	13	14	8	9	10	11	12	13	14	8	9	10	11	12	13	14	8	9	10	11	12	13	14
15	16	17	18	19	20	21	15	16	17	18	19	20	21	15	16	17	18	19	20	21	15	16	17	18	19	20	21
22	23	24	25	26	27	28	22	23	24	25	26	27	28	22	23	24	25	26	27	28	22	23	24	25	26	27	28
29	30						29	30	31					29	30						29	30	31				

Stop
00:00:00

00 01 02 03 04 05 06 07 08 09 10 11 12 13 14 15 16 17 18 19 20 21 22 23

1. Select if you want the rule to enable (**On**) or disable (**Off**) object.
2. Set start and stop time by moving the bar in the time axis or type the time in the boxes.
3. Mark the date in the calendar.

The rule will automatically be set to **Active**. You can **Inactivate** it by using the checkbox up in the corner. If you click **Cancel**, you will leave you the page without saving the changes you have made.

4. Click **Save**. The rule will now be included in the list on the overview page.

8.8.5 Periodically

This is used when you want something to be repeated a certain period.

The screenshot shows a configuration window titled "Periodically". At the top left, there are two buttons: "On" (highlighted in green) and "Off". At the top right, there is a checkbox labeled "Active" which is checked. The main area is divided into three sections. The first section is "Period time Every each" and contains four input fields labeled "Day", "Hour", "Minute", and "Second". The second section is "Duration" and also contains four input fields labeled "Day", "Hour", "Minute", and "Second". The third section is "Delay" and contains four input fields labeled "Day", "Hour", "Minute", and "Second", with the "Day" field containing the value "0". At the bottom right, there are two buttons: "Cancel" and "Save".

1. Select if you want the rule to enable (**On**) or disable (**Off**) objects.
2. Set **Period time**, this will decide how often the period should be repeated. For example, if you want something to be repeated every third day, type **3** under Day.
3. Set for how long you want it to be active under **Duration**. For example, two hours by typing 2 under **Hours**.
4. You can also add a **Delay**. This gives a delay into the period when the duration will be active. For example, five hours by typing 5 under **Hours**.

This means that it will be active every third day during 05:00 and 07:00.

The rule will automatically be set to **Active**. You can **Inactivate** it by using the checkbox up in the corner. If you click **Cancel**, you will leave you the page without saving the changes you have made.

5. Click **Save**. The rule will now be included in the list on the overview page.

8.9 Applications Status

Applications can have different statuses and they are indicated both on the application and in the node tree. Subapplications always have the same status as the head application.

Application status



Run: is used to run the application normally.



Stop: is used to stop the system, for example during maintenance. No script is running, all the alarms are blocked and channels will go back to their initial values.

In addition to these statuses, you can put the system in **debug mode** if you want to test the script. To use this mode, you must first stop the application by selecting the application and pressing **Stop** at the bottom of the page.



Pause: can be used for minor maintenance since it does not affect channel settings. Script execution is stopped, variables are not reset and there is no re-initialization of channels. Alarms and logs will function as normal. When the **run once** and **run to break** has been run through, they will finish in **Pause**.



Run once: is used to run the system to end or break point. When it has run once it will end in the paused mode.



Run to break: is used to run the system to a break statement in a script. When it has run to a break point it will end in the pause mode. Break points can only be used in script; you can read more about this in the Reference Manual (available at abelko.se).

You can also read about the different statuses in the web interface by clicking the **i** icon next to the status buttons.

8.10 Overview Icons Graphical Programming

Icons



Application (in the node tree)



Application (on the workspace)



Error-status



Debug-status



Channel (in the node tree)

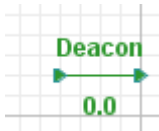

Channel (on the workspace)

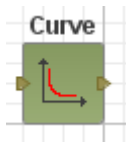

Curve



Run-status



Alarm



Alarm group



Log

Icons



Parameter



Pause-status



Summary

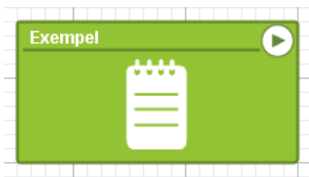

Script application



Stop-status

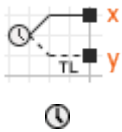

Time schedule: x is the time schedules status. If a rule says that the time schedule is On x is one, if the time schedule is Off x is zero. Y (TL) stands for Time Left and is the number of seconds until the schedule changes its status.



UltraBase



UltraTouch



Subapplication (in the node tree and on the workspace)



URL



Overview

8.11 Explanation of the Different Components

Operators



ANDNAND: if both a and b are true (non-zero), the output x is a. In all cases where x is one, y is one.

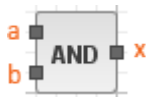

AND: if both a and b are true (non-zero), the output x is a. This component is extendable.

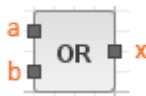

OR: if either a or b or both are true (non-zero), the output x is a. This component is extendable.

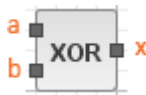

XOR: if a or b, but not both, are true (non-zero), the output x is a.

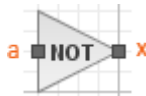

NOT: if a is true (nonzero), the output x is zero. Otherwise, x is one.

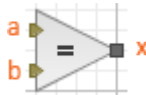

Equal: if a and b are equal, the output x is a.

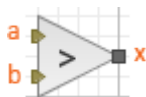

Greater than: if a is greater than b, the output signal x is a

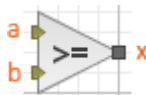

Greater equal: if a is greater or equal to B, the output x is a.

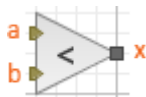

Less than: if a is less than b, the output signal x is a.

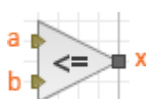

Less equal: if a is smaller or equal to b, the output x is a.

Operators

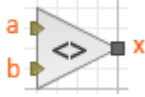

Not equal to: if a is different from b, the output signal x is a.

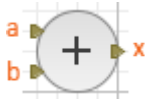

Addition: a plus b is the value of the output signal x.
This component is extendable.

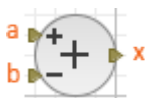

Subtraction: a minus b is the value of the output signal x.

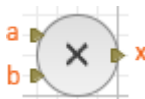

Multiplication: a multiplied by b, is the value of the output signal x.
This component is extendable

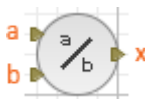

Division: a divided by b, is the value of the output signal x.

Components



SIN: $x = \sin(a)$ where a is an angle in radians.



COS: $x = \cos(a)$ where a is an angle in radians.



SIGN: keeps track on which value the input signal a has. If a is less than zero, the output signal $x = -1$. If a is greater than zero, $x = 1$. If a is exactly zero then x is also zero.



Absolute value: $x = \text{abs}(a)$, i.e. that a possible minus sign is removed.

Components



SQRT: the square root of a is the value of the output signal x.



Round: rounds the input signal a to the nearest integer which is the value of the output signal x.

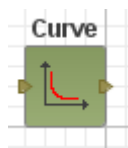

Curve: output x is the value at the y-axis corresponding to the input signals (a) position on the x axis.

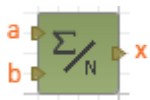

Average: is calculated on the input signals, the value of the output signal is x.

This component is extendable.

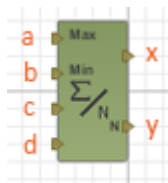

Conditional average: forming an average of the input signals (input C and higher) that lies between the max (a) and min (b). X is the mean, y is the number of values that meets this condition.

This component is extendable.



Median: is calculated on the input signals that will be the value of x.

This component is extendable.

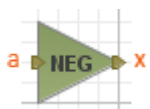

Negating: $x = a^{-1}$



Percent: a and c are set values that are compared with b. The output x is a percentage where between a and c b is. $x = 100 (b-c) / (ac)$, limited to be between 0 and 100. Useful for sequence control.

Components

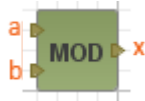

MOD: (Modulus) x is the remainings after the division a / b .

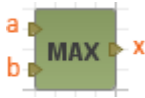

Max: selects the larger of the input signals as value for output signal x . This component is extendable.



Min: selects the smallest of the input signals as value for output signal x . This component is extendable.

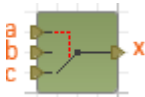

Switch: if a is zero, the output signal x equals c . If a is true (non-zero), the output signal x equals b .

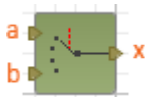

Multiplexer: the input signal a select which of the other input signals will be output signal. If $a = 0$ then $x = b$, if $a = 1$ then $x = c$, etc. This component is extendable.

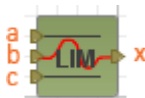

LIM: is a component that limits a signal. a specifies the upper limit, and c specifies the lower limit. If the input signal b is between the limits, the output x will have this value. But, if the input signal falls outside a or c , the output x will have the limit as a value.

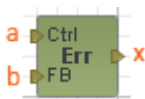

Feedback detector: if a or b , but not both, are true (non-zero), the output x is a .



Formula: the input signal a is calculated from the specified formula, which will give the value of the output signal x .

Status Components

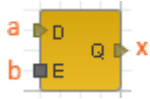

Latch: if the input signal b is true (non-zero), the output signal x is equal to the input signal a. If b is zero, the component will keep the previous value of the output signal. The signal will then freeze.

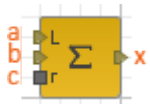

Sum: every second, the input signal is added to the sum, which is the value of the output signal x. If the absolute value of the sum is greater than a (Limit), the value is not increased. When the input signal c (RESET) is different from zero, the sum is set to zero.

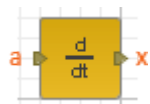

Derivata: output signal x is how much the input signal a has changed since previous second.

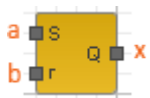

RS flip flop: if the input signal a (set) is true (nonzero), the output signal x has the value one. X remains one until b (reset) becomes true, then x is set to zero. At start-up, x is zero.



Date: x is the current year, y is the current month (1-12) and z is the current day of the month (1-31).



Time: x is the current hour (0-23), y is the current minute (0-59) and z is the current second (0-59).

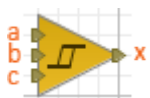

Hysteresis: a and c are limit values. When b is higher than a, x is set to one. When b is less than c, x is set to zero.

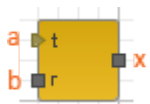

Timer: output signal x is one, during the number of seconds that a (timer) specifies. Then it becomes zero. If b (reset) reaches zero, the clock will start again and x is one for a seconds. At startup, the clock is active and x is one.

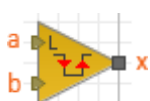

Flank detector: output signal x becomes one each time the input signal b passes the limit value a.

Status Components

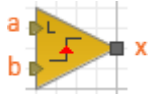

Flank detector pos: output signal x becomes one each time the input signal b passes limit value a on the way up.

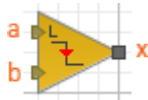

Flank detector neg: output signal x becomes one each time the input signal b passes limit value a on the way down.

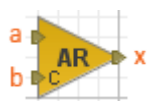

AR filter: autoregressive filter with filter factor b (Coefficient), which should be between zero and one. Zero means no filtering and one that the input signal a never goes through to the output signal x.



On/Off delay: delays the input signal b. When b is set to true, it must be true a seconds in a row before the output signal x becomes true. When b is set to zero and x is one, the x is changed to zero when b been zero c seconds in a row.

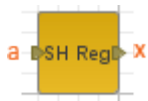

Shift register: with adjustable length (N). The input signal a is delayed for N seconds in the component, before it comes out in x.

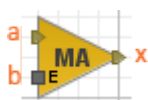

MA-filter: (Moving Average-filter) the filter has a buffer for values. The number of values that can fit in the buffer is adjustable. Every update (second) which b (Enable) is true, the value from a is stored in a buffer and the oldest value is lost. The output signal x is the average of the values in the buffer.

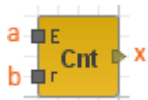

Counter: if a (Enable) is true, then x is added up every seconds. If b (Reset) is true, then x is set to zero.

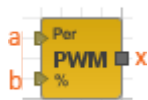

Pulse width modulation: the component creates a square wave with a period of seconds. b indicates how much of a that output x shall be high.

Other



Acknowledge all alarms: used to acknowledge all active alarms in the application in which it is located. This can not be placed on the top Ultra level. Acknowledgement is done when a changes from zero to be non-zero. Can be used for a physical acknowledge alarm button on a cabinet. Acknowledgment signature becomes —.



Total active manual override count: the component outputs the total count of active manual overrides for channels and I/O-channels. The output x indicates the number of manual overrides.

9 Overviews

Overviews provide a quick overview of the plant. You can add present values, alarms and more to this picture. In this chapter, you will learn how to create and edit overviews.

Overviews are created under the menus **Configuration** and **Overviews**. If you have used the controller tool in the graphical programming, there will already be a foundation for the overview. This is listed to the left with the same name as when you created them in the controller tool.

An overview created with the controller tool has a size of 720x300 pixels

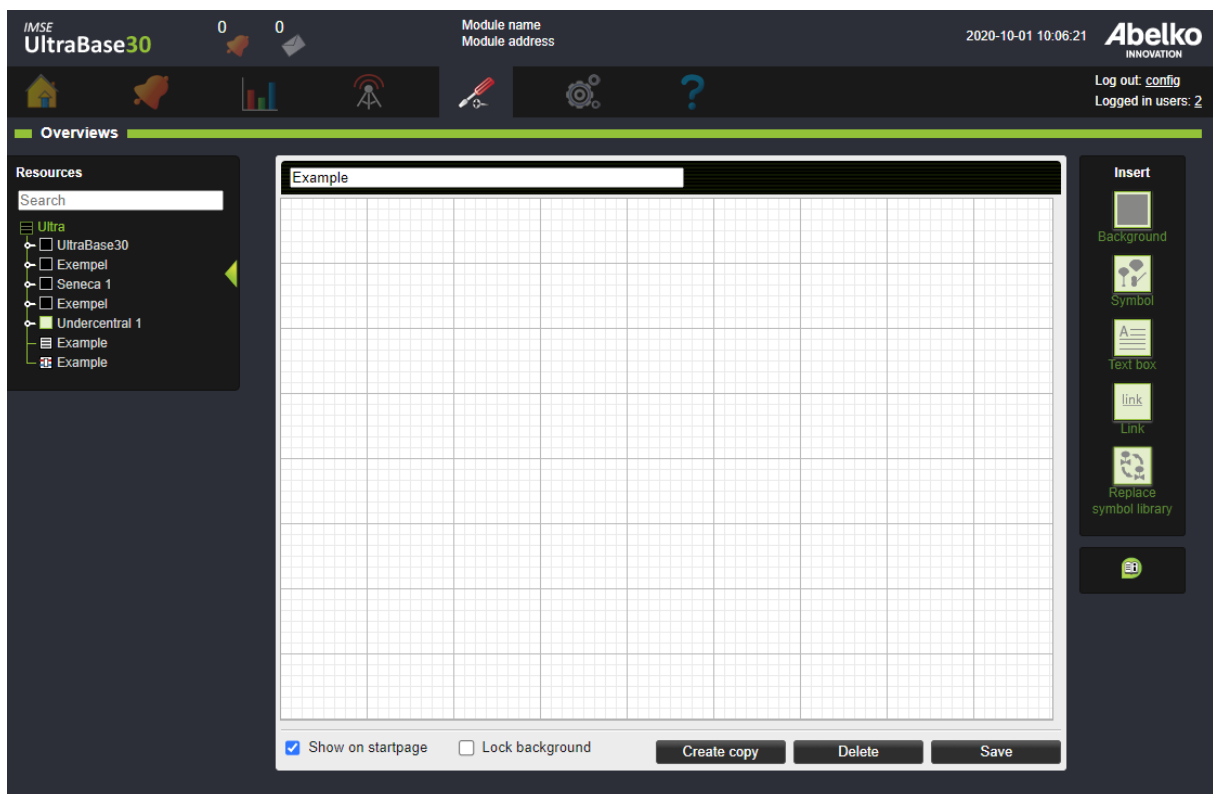

9.1 Create a New Overview

1. Decide for which application you want to create the overview. If it is not going to part of an application, you can create it on the top level (directly under the Ultra). If not, create it under the application you want to add values from. You can add and use channels, parameters and more from applications on the same level, as well as their subapplications.
2. Click **Create new** and name the overview.

3. Click **Save**. Now you can drag-and-drop resources from the node tree and edit them with the tools on the right. To find the unit's resources more easily, you can use the search function at the top of the tree view. **Regular Expression** is a programming language that uses special syntax rules. For example [abc] shows all resources containing a, b or c. Another example is four|4 which shows all resources containing either four or 4.

9.1.1 Add Backgrounds

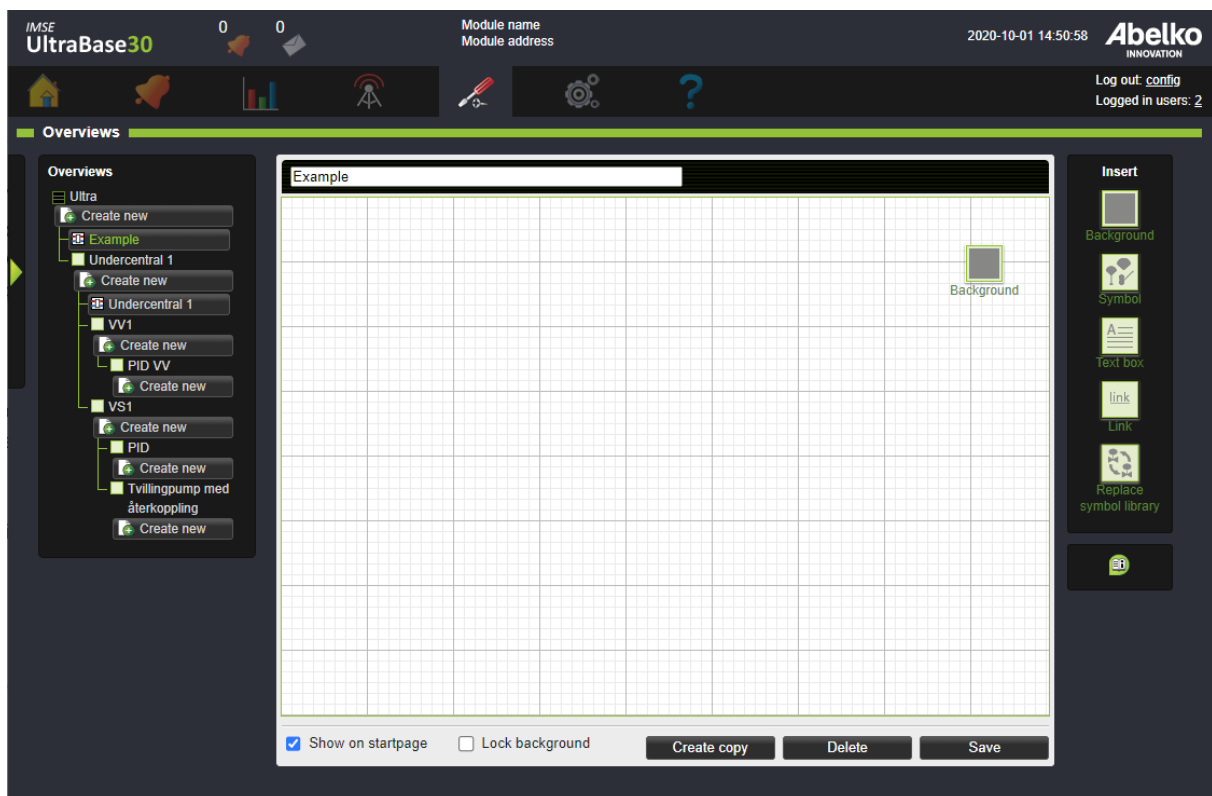

1. To add a background, use the **Background** tool in the **Insert** menu to the right. Grab the **Background** and drop it on the workspace.
2. You can select which image you want to use as a background, or you can also use a single color as a background. Once your background is determined, you may repeat it across the entire background or just parts of the background.
3. Click **OK**.

If you have an image as a background that does not cover the entire workspace, you can add a color as a background under the image.

The background (together with all symbols not associated with a channel) can be locked by ticking the check box **Lock background**.

9.1.2 Add Resources

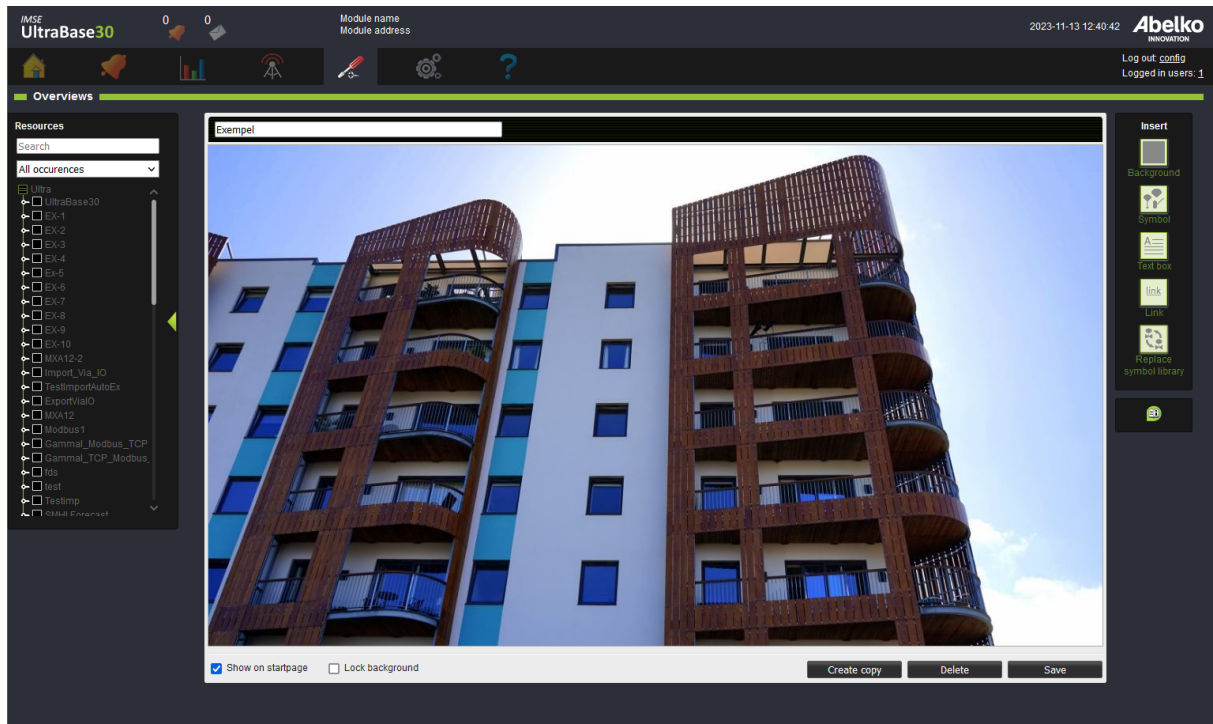



1. When the image is in place, you can drag-and-drop resources from the node tree onto the workspace. For example, time schedules can be helpful, so you add it to the overview for quick access.



2. By hovering your mouse over an item, you can edit **view alternatives** or **erase** it. When you mark a value on the overview, it will be marked in the node tree. This also works in the opposite direction: if you mark a value in the node tree, it will be marked out on the workspace.



Format is a view alternative where you can decide how the resource should be viewed by combining **Name**, **Value** and **Unit**. By dragging-and-dropping the same resource and changing their view alternatives, you can split the resource to adapt it to the background. You can also link a resource with an **Symbol**. Choose which **Symbol library** the symbol should be downloaded from. Some of the images will change their appearance when the value changes (for example when a pump goes from inactive to active).  



A channel can also be viewed as an **Active meter**. This is a graph that will update when new values come in.



9.1.3 Create custom symbol libraries

There is a standard library with several symbols in the UltraBase. But if you want to add your own symbols, there is a program to create your own library, Symbollib creator. The program can be found on www.abelko.se. You can upload new symbol libraries to the **Symbol library** folder under the menu **System** and **File manager**.

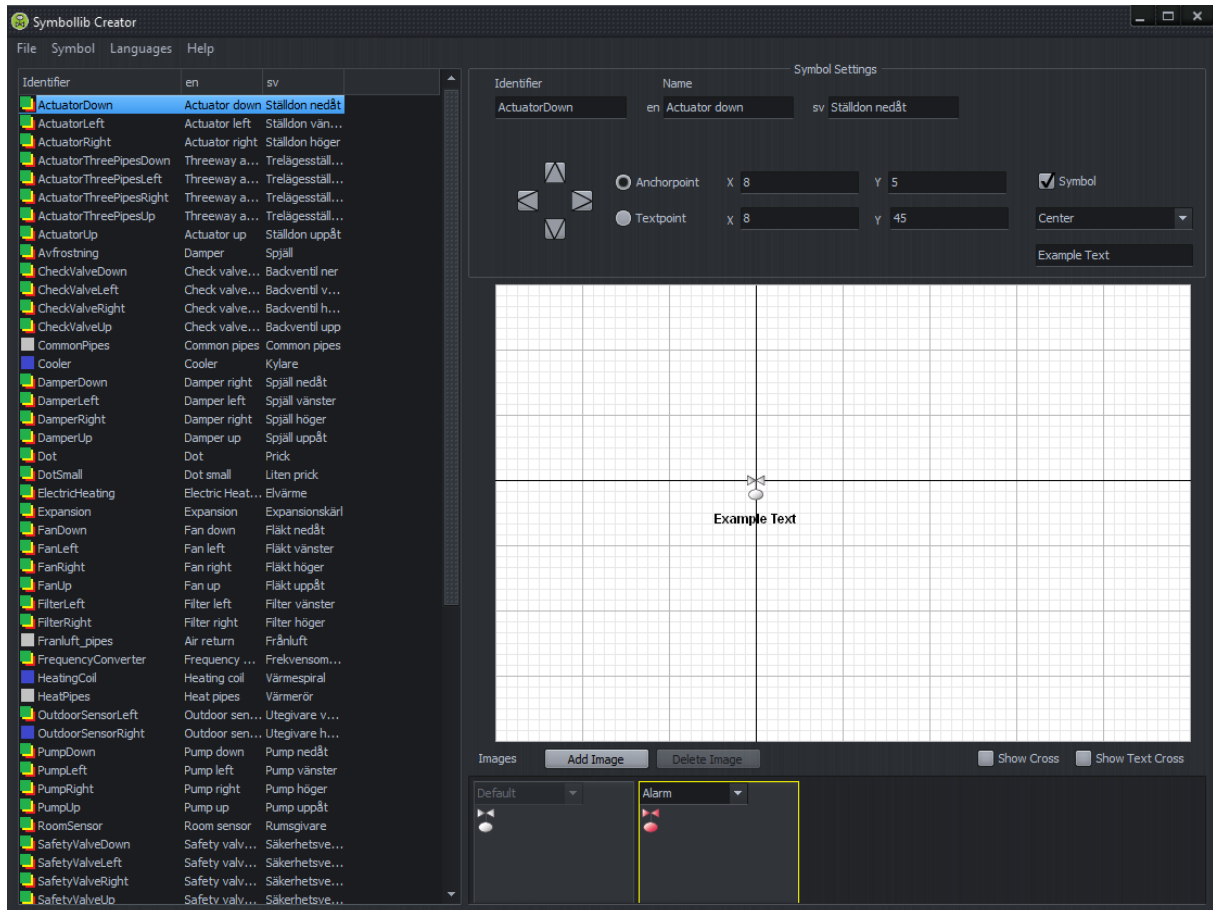

9.1.4 Add Text Boxes and Links

1. You can add your own text and links in the overview using the tools **Text box** and **Link**. These are located under the menu **Insert**.

Detta är en översikt över bostadsområde A.



2. You can easily link to other **overviews** and **summaries** by dragging and dropping them from the list **Resources** to the left. If you want to link from a companion, use the tool **Link**. When you create links, you can link back to the other overview to easily navigate between them.
3. When you are satisfied with the overview, click **Save**.

The overview is now available in the node tree, and you can choose to have it as your homepage (this setting is located under the menu **System** and **Settings**). If you don't want it to be available to view, deselect the **Visible** box next to its name.

9.1.5 Create copy of an Overview

An Overview can be copied with the button **Create copy**. When copying an overview it is possible to select under which application the copy shall be placed.

9.2 Tools

Tools



Background used to add a single colored background or an image as a background.



Symbol used to add symbols and images uploaded to the Ultra or symbols from the symbol library.



Text box used to add a box with text.

Tools



Box used to add a colored box.



Line used to add a colored line.



Link used to add a link to web pages and more. You can choose your own link text.



Replace symbol library used to change symbol library. If there are corresponding symbols in the library you are switching to, the symbols that are used are changed to the new symbols.

9.3 View Alternatives

View Alternatives



Format shows the value like a text with different alternatives for name, value and unit. The value can also be connected to a symbol. Some of the symbols will change appearance when the value changes, for example when a pump goes from active to inactive.



Active meter shows the value as a graph, which is updated as new values come in. You can set the x-axis so it will remember and keep the max height in the graph.

9.4 Keyboard shortcuts

Keyboard shortcut	Description
Arrow Keys	Moves the selected symbol(s) 1 pixel.

Keyboard shortcut	Description
CTRL + Arrow key	Moves the selected symbol(s) 5 pixels.
SHIFT + Arrow key	Moves the selected symbol(s) 10 pixels.
CTRL + SHIFT + Arrow Key	Moves the selected symbol(s) 80 pixels horizontally or 60 pixels vertically.
ALT + Arrow key	Moves the selected symbol(s) 10 pixels and snaps the anchor point of the symbol to the grid.
ALT + SHIFT + Arrow key	Moves the selected symbol(s) 80 pixels horizontally or 60 pixels vertically and snaps the anchor point of the symbol to the grid.
CTRL + Mouse button	Select / deselect a symbol.
SHIFT + Mouse drag	Create selection box that selects completely completely contained symbols.
SHIFT + Mousedrag from resource tree	Drag all resources that are visible, of the same type, and that belong to the same application/io-unit as the dragged resource (max 100 resources).
CTRL + SHIFT + Mousedrag from resource tree	Drag all resources that are visible and of the same type as the dragged resource (max 100 resources).
CTRL + A	Select all symbols.
DELETE	Deletes selected symbol(s).
CTRL + Z	Undo the last symbol drag and drop.
CTRL + S	Save the overview.
CTRL + L	Locks the background and all symbols not associated with a channel. Locked symbols cannot be selected or moved.
ESC	Deselect all selected symbols.
Right click or CTRL + E	Go to settings for the object.
CTRL + D	Duplicate selected object(s).

10 Summaries

Summaries are custom menu pages for applications. Here you can gather settings and information tailored for an end user. In this chapter, you will learn how to create and edit summaries. We start by going through an example and then explain the different tools and components in more detail.

You create summaries under the menu **Configuration, Summaries**. If you have used the controller tool in the graphical programming, there will already be a foundation for the summary. These are listed to the left with the same name as when you created them in the controller tool.

10.1 Create a New Summary

1. Deciding for which application you want to create the summary. If it is not going to part of an application, you can create it on the top level (directly under the Ultra). If not, create it under the application you want to add values from. You can add and use channels, parameters and more from applications on the same level, as well as their subapplications.
2. Click **Create new**, and name the summary.
3. Click **Save**. Now you can drag-and-drop resources from the node tree and edit them with the tools on the right.

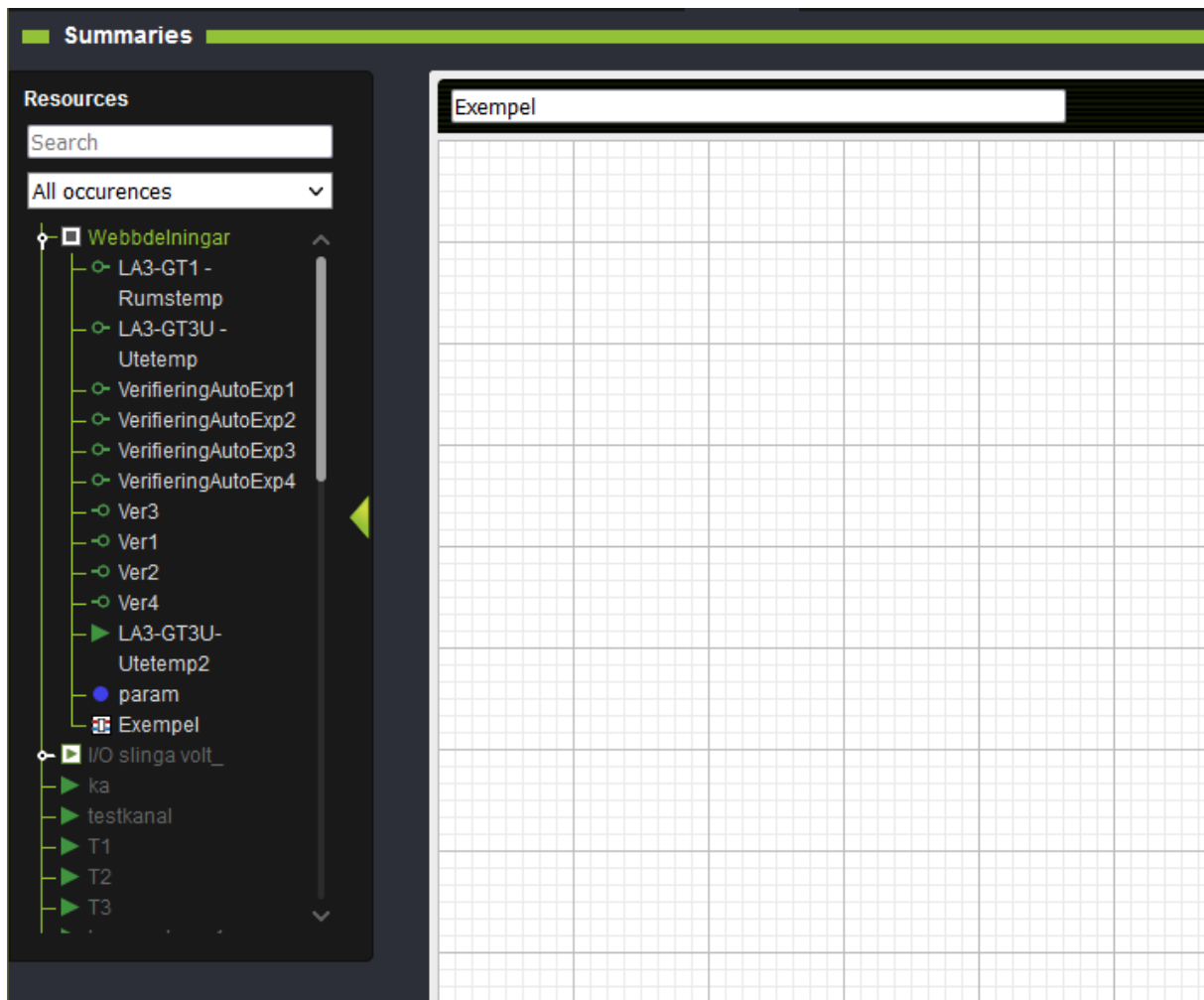

- The tree view will extend when you click save. Add resources by dragging-and-dropping them on the workspace. Channels, alarms, set points, and more will be available under each application in the tree view. Time schedules are good to have, makes it easier to access and edit them. To find the unit's resources more easily, you can use the search function at the top of the tree view. **Regular Expression** is a programming language that uses special syntax rules. For example [abc] shows all resources containing a, b or c. Another example is four|4 which shows all resources containing either four or 4.

In the following figure we have added a channel. The default view shows name, value and unit.

IMSE UltraBase30 0 0 Module name Module address 2020-10-01 15:30:28 **Abelko** INNOVATION

Log out: [config](#)
Logged in users: 2

Summaries

Resources

Search

- Ultra
 - UltraBase30
 - Exempel
 - Seneca 1
 - Exempel
 - Undercentral 1
 - Supply temp
 - Actuator 1
 - Outdoor temp A
 - Flow temp
 - P1 indication
 - P2 indication
 - Actuator 1
 - P1
 - P2
 - VV1
 - VS1
 - VV_PID
 - Kurvor
 - HEAD_PID
 - Rumskompensering
 - PID

Example

▶ Actuator 1 5.0 kW

Edit

- Color
- Abc Header
- Text box
- Image
- Link
- Link
- Group edit
- Button
- if a < b Rule

Show on startpage Delete Save

By hovering your mouse over an item, you can edit **view alternatives** or **erase** it.

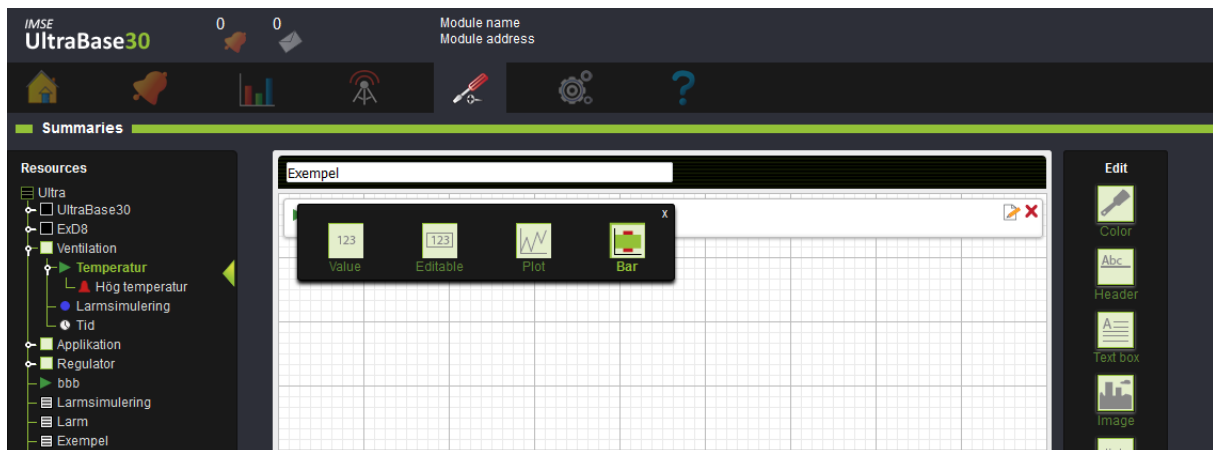

5. To modify the appearance of the summary, use the menu **Edit** to the right. Drag the desired editing icon from the menu and drop it on the resource you wish to change.
6. **Color** changes the color of a frame, a text or a background. **Header** adds a break with a header; this helps to divide and group the resources. You can create **Text boxes** and add **Links** and **Images** that will be handled as an element in the list.

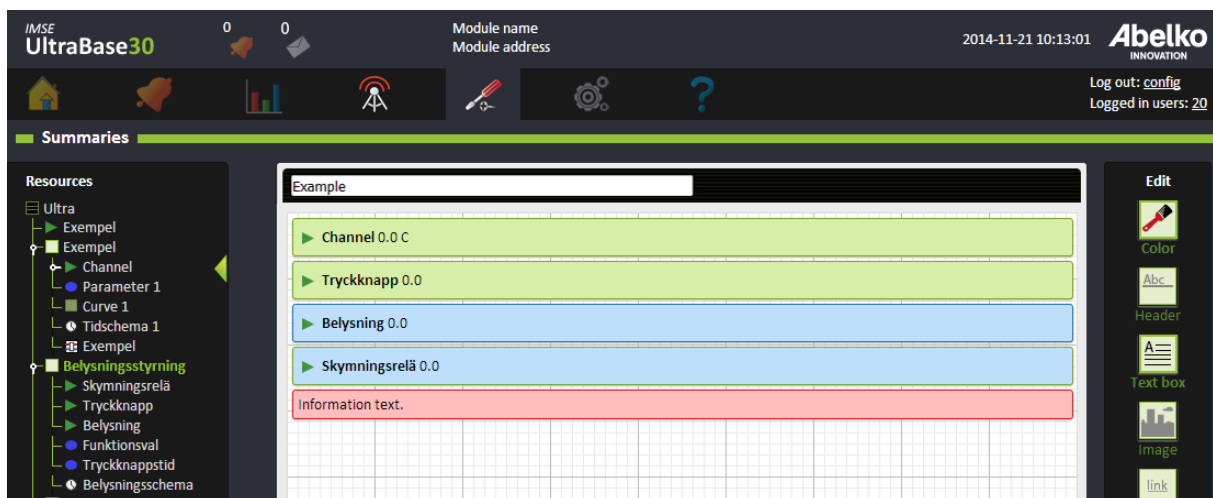

7. Group edit edits multiple resources at the same time. Button sets several values at the same time. Drag-and-drop the resources you want into the selected area. The value you enter in the box will be the value that is copied to the other resources when you press the button. **Rule** controls the view of a row. For example, you can choose a row to be visible if an alarm becomes active.

8. To reorder the summary rows, drag-and-drop them into the desired order.
9. When you are satisfied with the summary, click **Save**.

It will now be visible in the node tree. To make it your homepage, open the menu **System, Settings**. If you don't want it to be visible, deselect the **Visible** box at the bottom of the page.

10.2 Summary Tools

Tools



Color used to color backgrounds, frames and texts.



Header used to group and separate resources to organize overview.



Text box used to add a box with text or to add an explanatory text to another object.



Image used to add images uploaded to the Ultra.



Link used to link other overviews, summaries, files or URL-adresses. You can choose your own link text.



Group edit allows you to group resources to edit them at the same time.



Button used to add a function that will happen when the button is pressed. One or more values can be set when a user presses the button.



Rule adds rules for when something is shown or hidden. Drag-and-drop the rule-tool to an already added object, then add conditions for when the object will show or hide.

10.3 View Alternatives

These options are accessed by hovering your mouse over a resource and clicking **Edit**.

View Alternatives



Value shows the value as a text with different alternatives for name, value and unit. This is being used for static parameters like temperatures.



Editable allows manual editing from the page for a resource.



Plot shows the value as a graph and is updated continuously.



Bar is a bar chart that is automatically updated continuously. The value is displayed as a bar. Alarm limits and set points can be displayed as reference.

10.4 Channels

Channels can be viewed in several ways. As a default, it will appear in a row with name, value and unit. It can also be viewed as a plot or bar; hover your mouse above it and click on the **Edit** icon.

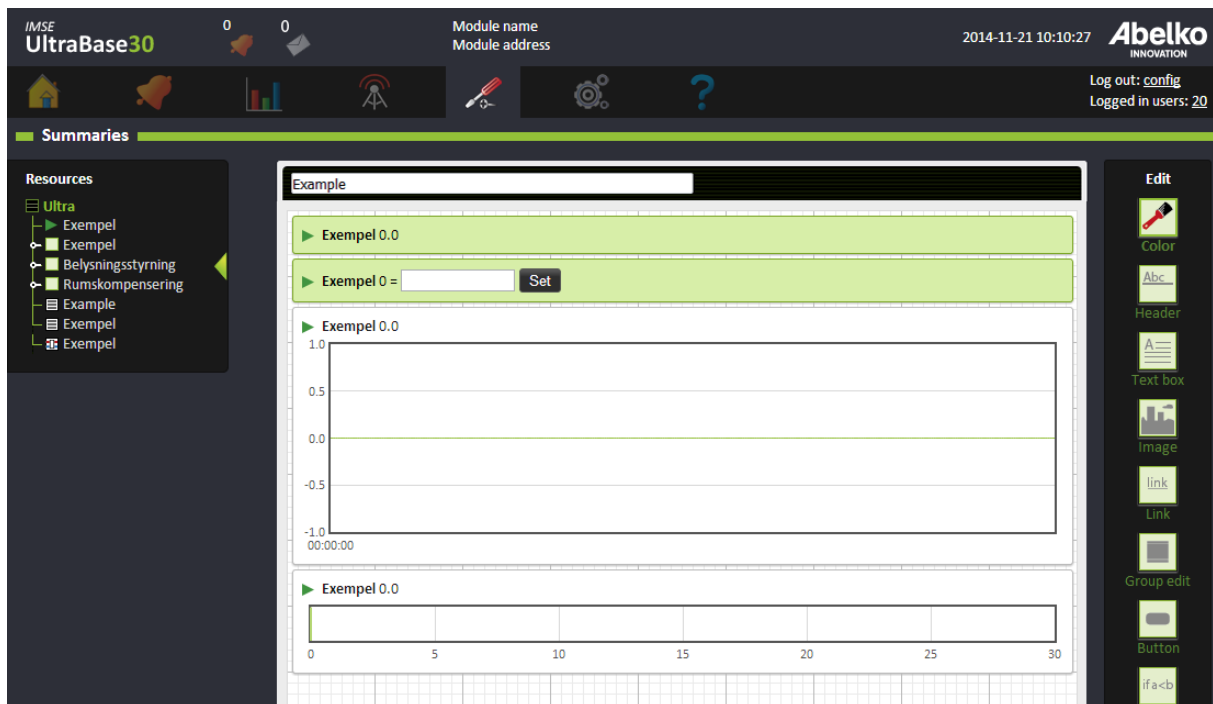

If you choose to display as a bar the current value is illustrated as a horizontal bar. You can choose to drag-and-drop the channels alarm to display its alarmlimits. If you drag-and-drop another channel or parameter it is shown as a line. This can be used to display e.g. a set point.

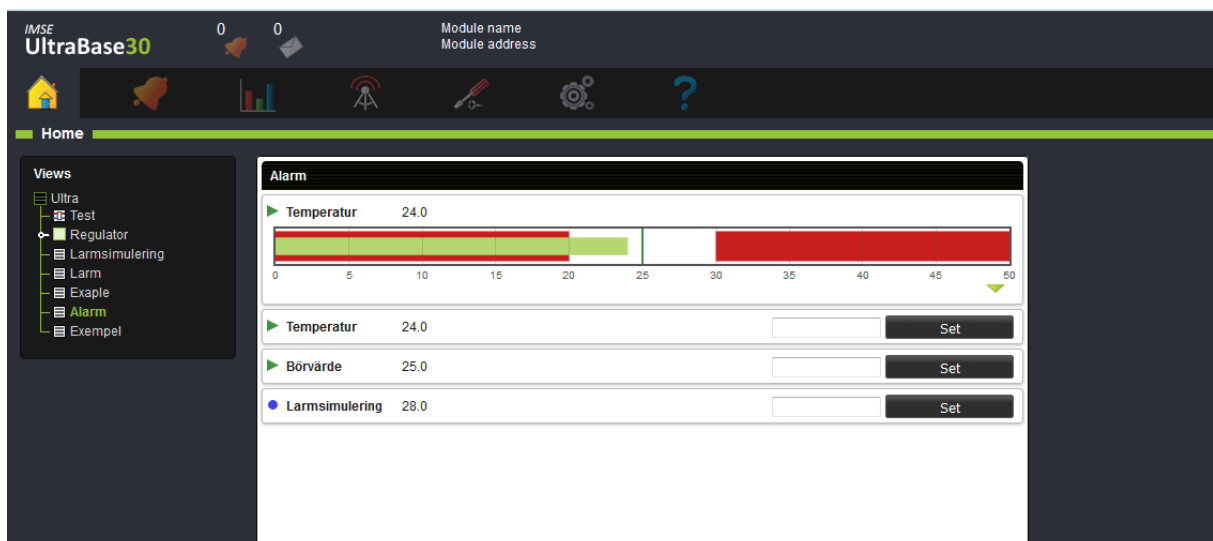

10.5 Alarms

When you add an alarm to the workspace, its name and current status will appear.

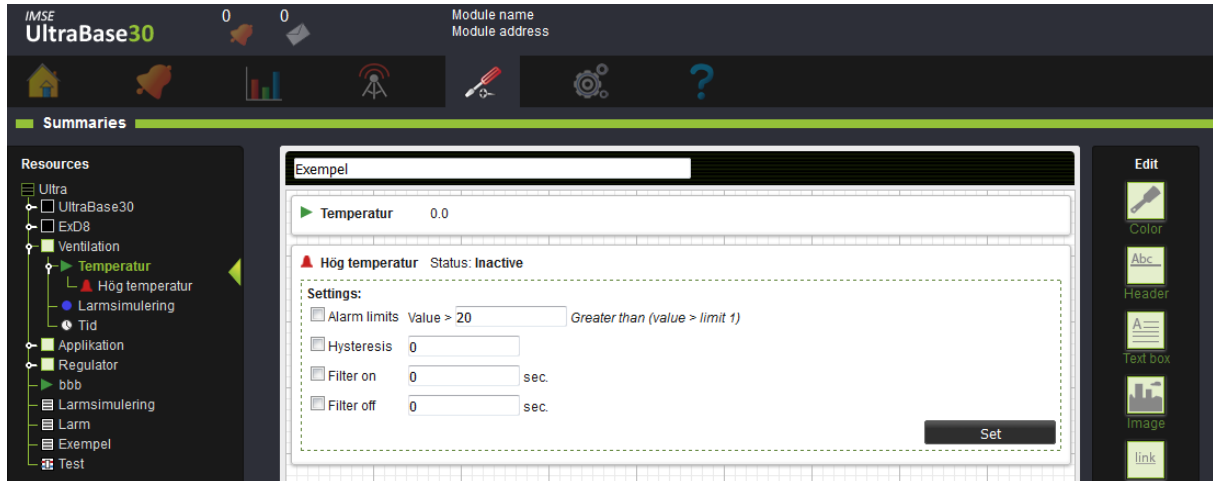

10.6 Time Schedules

When you add a time schedule from the node tree to the workspace, its name and current status will appear. In view mode, an edit button is available so you can edit the time schedule.

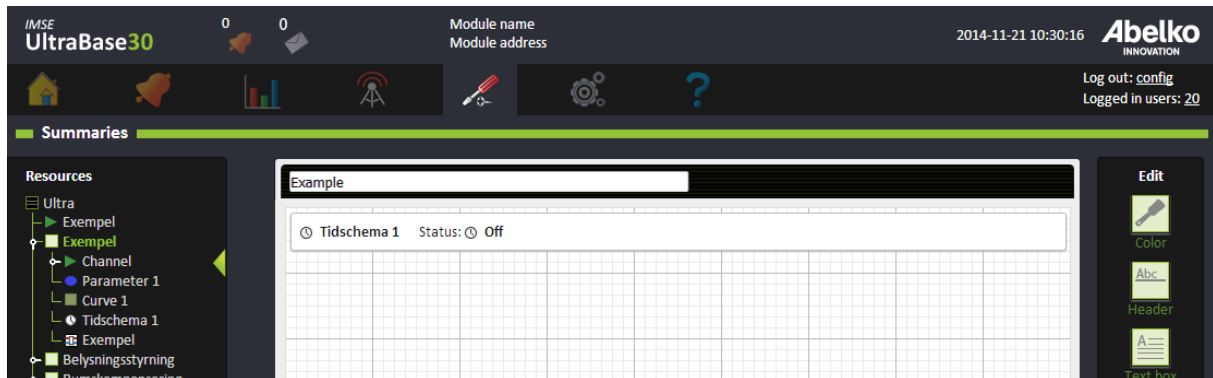

10.7 Parameters

Parameters can be both editable and non-editable. Hover the mouse over the parameter and click on the **edit** icon. Here you can choose if you want it to be editable (**Value**) or non-editable (**Set**).

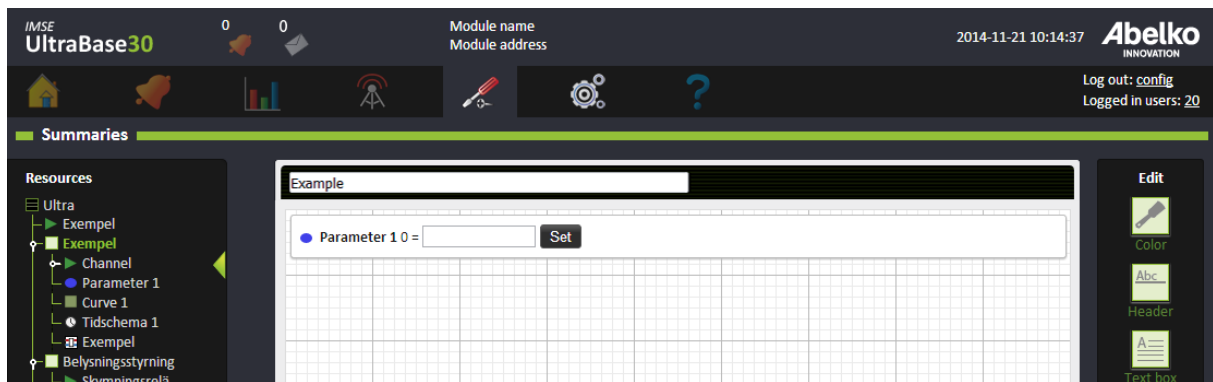

10.8 Curves

To view curves as a graph, **drag-and-drop** the curve onto the workspace. When you have a finished summary, you will be able to edit the data points of the curve.

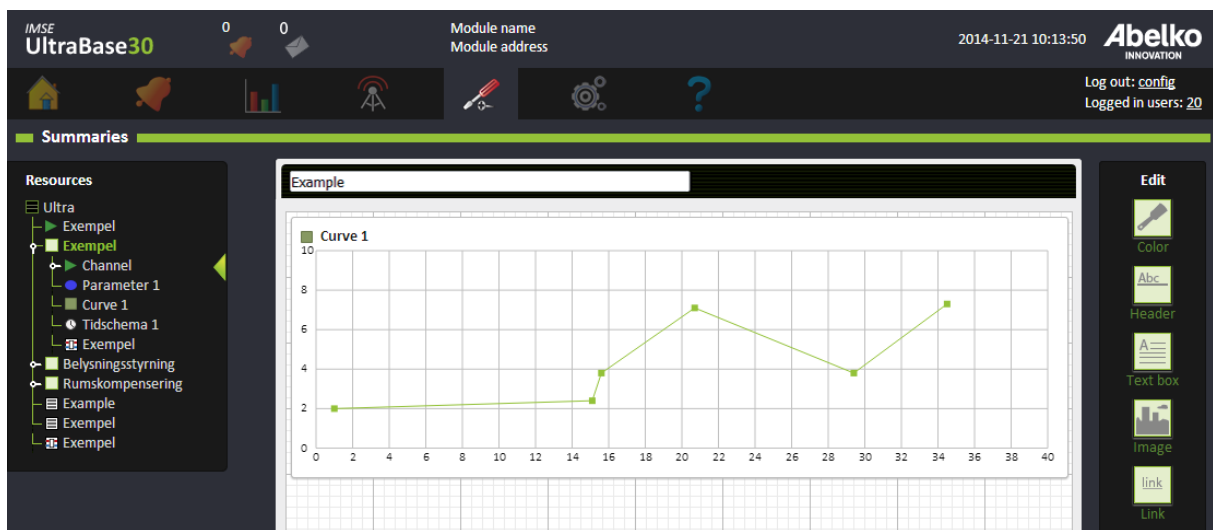

10.9 Overview in- & outputs

To add an overview of in- & outputs to a summary page you simply choose the module you want to show from the resources on the left hand side and **drag-and-drop** it onto the workspace. You can edit the manual control of all in- & outputs and view current values.

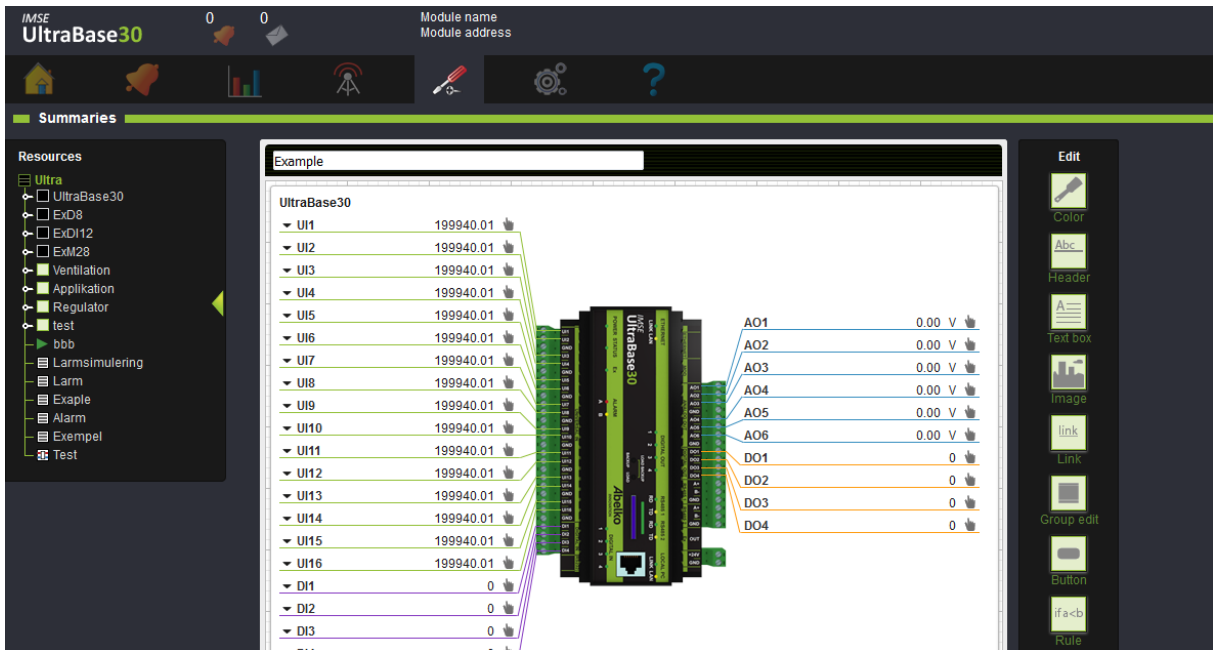

10.10 Summaries in summaries

Summaries can be added to other summaries. **Drag-and-drop** from the resource menu on the left. You can choose if they will start opened or closed. This can be used to create a deeper menu structure.

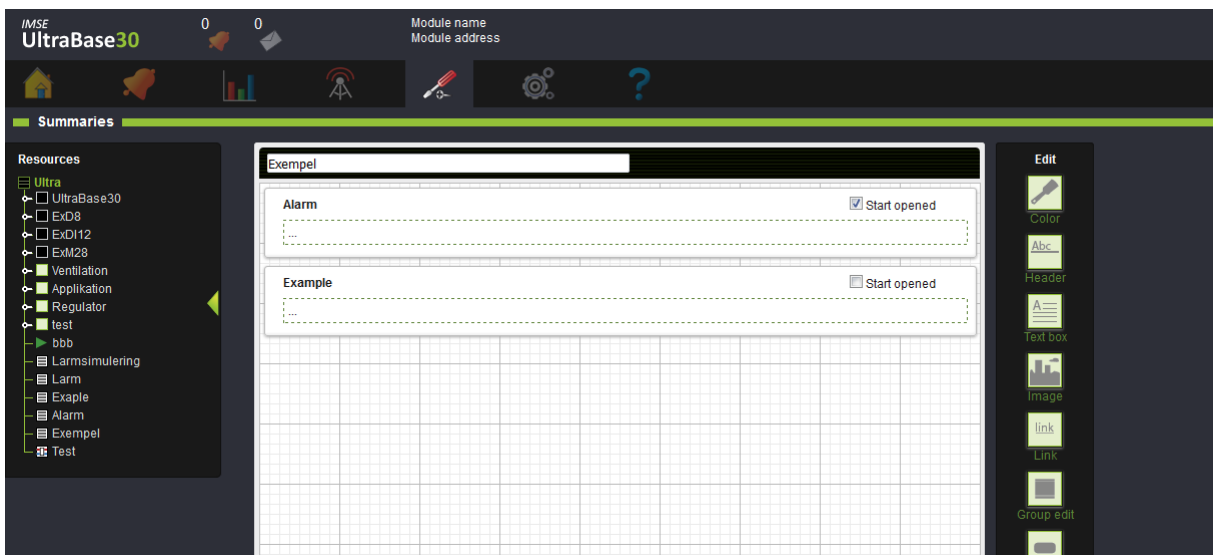

11 Alarms

This chapter will explain the different types of alarms. You will learn how to create and edit alarms and alarm groups. You will use these alarm groups to create alarm sendouts and black boxes.

You will find **Active alarms** and **Alarm history** under the **Alarms** menu.

11.1 Active Alarms

All active alarms in the system are listed on **Active alarms**. The number of active alarms will also be indicated on the top of the web interface. When it has a red symbol, it means that at least one of the active alarms is an **A-alarm**. When it has a yellow symbol, at least one of the active alarms is an **B-alarm**, and a blue symbol is when at least one alarm is a **C-Z alarm**. If the symbol is blinking, it means that there are alarms that need to be acknowledged.



You can see and acknowledge active alarms in this list. When these alarms are inactivated, they will appear in the alarm history. Both the reset and the acknowledgment is stored in the alarm history.

11.2 Alarm Types

An alarm is created based on a channel in the graphical programming and can have different types of priorities. **A-alarms** have a red indicator and **B-alarms** have a yellow indicator. They can also have a priority from **C-Z**, which have blue indicators. Alarms can have different types of acknowledgments.

In addition to these types, there are **events/errors** and **messages**. **Events/ errors** are created by the system and provide information when there is an error in the system, preventing from working properly.

Messages are created by script and provide information concerning system changes, such as the system being switched over to summer mode.

11.3 Edit Alarms

An overview of all the alarms is found and editable under the menu **Alarm, Alarm list**.

A complete list of all systems resources is found under the menu **Configuration, Applications & resources**.

IMSE
UltraBase20

Elapparatskåp LA1
Utvecklingsavdelning

1 11

Alarm list

Created alarms System alarms Export

Alarm list Filter: Search

Application - Channel - Alarm	Priority	Alarm message ▲	Acknowledgement type	Edit
LA1 - Overheating - Elh. overheating	A-alarm	Överhettning i elvärmebatteri. Blockering av värme aktiv	Reset when acknowledged	
LA1 - EXT_START - AL - Extern start via serverrum	B-alarm	Start av LA1 har skett via serverrum. Kontrollera temperatur i serverrum.	Automatic reset, no acknowledgement	
LA1 - Timer - AL1 - Serviceomkopplare i manuellt läge	B-alarm	Serviceomkopplare i manuellt läge	Automatic reset, no	

Click **Edit** to view and change alarm settings.

Edit alarm [X]

Channel: Control error - Name: LARM_REGLERFEL Change channel name

Priority: A

Condition: Outside (limit 1 > value > limit 2) Limit 1: -10 Limit 2: 10

Hysteresis: 1

Filter on: 60 sec. Filter off: 60 sec.

Acknowledgement type: Automatic reset, no acknowledgement

Alarm message: Message_Alr66_JAKV

Cancel Save

You can change the name of the alarm, see which channel it belongs to and change conditions and alarm limits. Under **Optional settings**, you can edit **Hysteresis** and **Filter**.

The different **conditions** are:

- **Equals (value = limit 1)**: the alarm is activated when the value is exactly the same as the value entered under Limit 1.
- **Greater than (value > limit 1)**: the alarm is activated when the value is greater than the value entered under Limit 1.
- **Less than (value < limit 1)**: the alarm is activated when the value is less than the value entered under Limit 1.
- **Greater (abs (value) > limit 1)**: the alarm is activated when the value is greater than the value entered under Limit 1 without taking into account whether the value is positive or negative.
- **Smaller (abs (value) < limit 1)**: the alarm is activated when the value is smaller than the value entered under Limit 1 without taking into account whether the value is positive or negative.
- **Between (limit 1 < value < limit 2)**: the alarm is activated when the value is between the values

entered under Limit 1 and Limit 2.

- **Outside (limit 1 > value > limit 2):** the alarm is activated when the value is below the value entered under limit 1 or above the value under Limit 2.

The **Hysteresis** settings prevent the alarm from repeatedly switching between active and inactive when the value is equal to the limit. It specifies the number of degrees by which the value must fall back below the limit or limits before the alarm can be cleared.

The **On-filter** specifies the number of consecutive seconds the alarm condition must be true before the alarm is triggered. The **Off-filter** specifies the number of consecutive seconds the alarm condition must be false before the alarm is cleared.

The different **acknowledgments** are:

- **Reset when acknowledged:** the alarm remains active until a user acknowledges it. If the error remains after the alarm is acknowledged, it will remain active until the error is cleared, including the delay and hysteresis.
- **Automatic reset, with acknowledgment:** the alarm reset itself when the error is cleared, but it still has to be acknowledged. In this case, the acknowledgment is a kind of confirmation that someone has noticed the alarm. Details of the reset and the acknowledgment are both recorded in the alarm history.
- **Automatic reset, without acknowledgment:** there is no need for a user to acknowledge the alarm. The alarm is cleared when the error is no longer active as defined in the alarm conditions. You can specify delay and hysteresis values in the condition.

11.4 Create Alarm Groups

Create alarm groups by grouping alarms from an application.

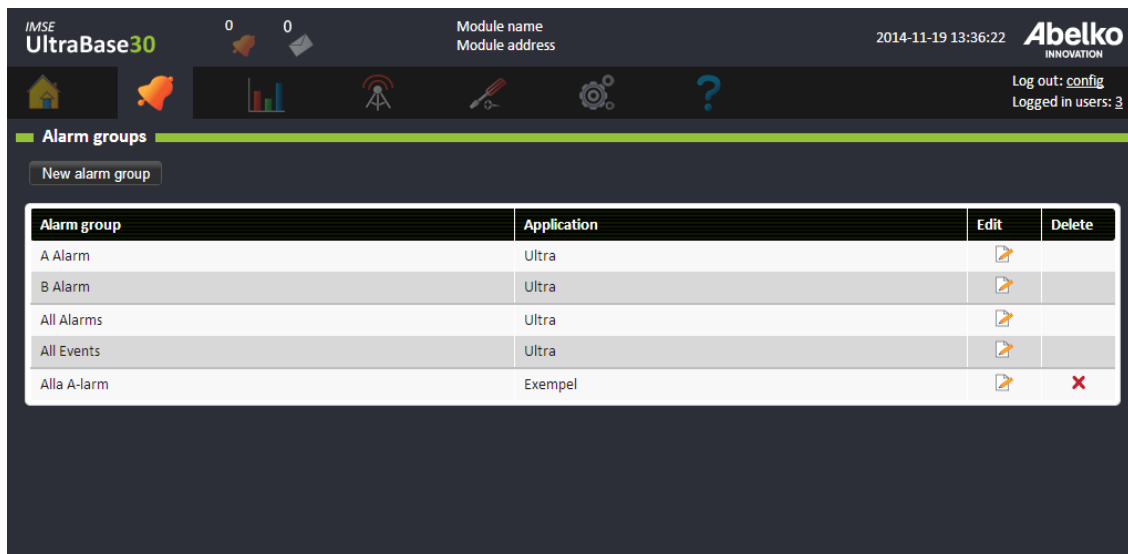

1. Create a new alarm group by clicking **New alarm group**.
2. **Name** the group and choose which language the sendouts will be in. Choose what type the sendout should be.

There is a default setting for **Comprobo** that should be used if you use IMSE Comprobo as an alarm system. There is also a standard format that fits better if the mail is sent directly to a human receiver. You can also choose to define your own format. This can be used if you send the mails to any other alarm system than Comprobo. The website provides help with the syntax for defining the messages. You can drag-and-drop keys for the values to the boxes for subject and text and mix it with free fixed text.

New alarm group ✕

Name Application
Ultra

Language
Swedish ▾

Type
Standard mail format for Comprobo ▾

Alarm priorities

A B

C D E F G H I J K L M

N O P Q R S T U V W X

Y Z

Application	Channel - Alarm	Priority
<input type="checkbox"/> Undercentral 1.VV1	Control error - LARM_VVC_REGLERFEL	B
<input type="checkbox"/> Undercentral 1.VS1	Control error - LARM_REGLERFEL	A
<input type="checkbox"/> Undercentral 1.VS1	P1 running error - P1 running error alarm	None
<input type="checkbox"/> Undercentral 1.VS1	P2 running error - P2 running error alarm	None

3. Mark the alarms you want in this group. The benefit of using this method of creating alarm groups is that you can choose alarms from the entire system.
4. Future alarms can be automatically added to created alarm groups. For example if you want all the **A-alarms** in the system to be part of a group, check the box next to the **A**. By doing this, all future **A-alarms** created in the system will also be included in the alarm group.
5. Click **Save**.

To set up mail sendouts for alarm groups, go to the Alarm sendouts menu.

11.5 Alarm Sendouts

Here you can create and edit alarm sendouts.

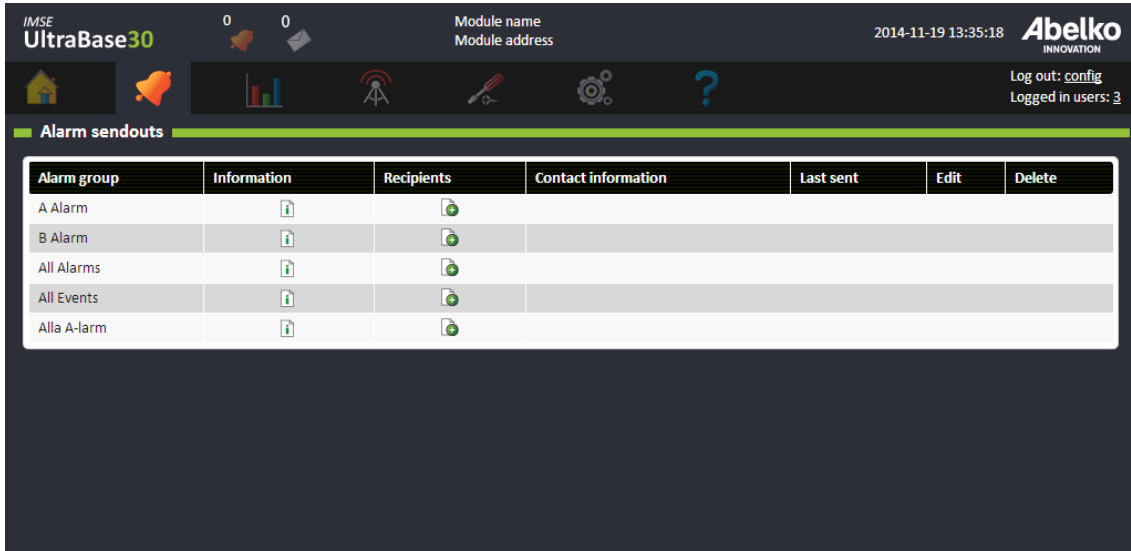

The screenshot shows the IMSE UltraBase30 interface. At the top, there is a header with the logo, version (0), and date/time (2014-11-19 13:35:18). Below the header is a navigation bar with icons for home, notifications, statistics, alarm, settings, and help. The main content area is titled "Alarm sendouts" and contains a table with the following columns: Alarm group, Information, Recipients, Contact information, Last sent, Edit, and Delete. The table lists five alarm groups: A Alarm, B Alarm, All Alarms, All Events, and Alla A-larm. Each row has an information icon in the Information column and a plus icon in the Recipients column.

Alarm group	Information	Recipients	Contact information	Last sent	Edit	Delete
A Alarm						
B Alarm						
All Alarms						
All Events						
Alla A-larm						

1. Alarm groups must be created before editing alarm sendouts (see previous chapter).
2. Click add new under **Recipients**. Choose a recipient in the list (these are created under the menu **Communication, Sendouts**).

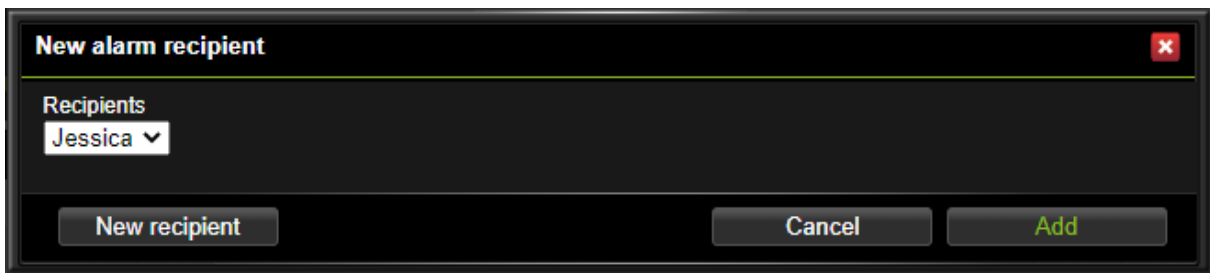

The screenshot shows a dialog box titled "New alarm recipient" with a close button (X) in the top right corner. Inside the dialog, there is a label "Recipients" above a dropdown menu showing "Jessica" with a downward arrow. At the bottom of the dialog, there are three buttons: "New recipient", "Cancel", and "Add".

New recipient ✕

Name

Email

Mail host
 Gmail ▾



- If you want to add a new recipients but don't have a Mail host you must first fill out the Mail host settings under the Communication menu.

11.6 Events/Errors and Messages

AeA error

There has been an error in the AeA-system. The error prevents connected expansion modules (EX modules) from functioning properly.

Application restore

The system has restored an application backup.

Database error

Logging and access to one or more databases are halted.

Email error

An error occurred when an email was about to be sent. This may be due to incorrect settings or communication error. Check email settings to verify **Server** etc. are correct.

HW_ERROR

There has been an error in the hardware that prevents the device from functioning properly. Try to cut off the power and restart the device.

NTP error

The system has not received any time from NTP, which means that the system cannot confirm that the time is right. One of the reasons may be that it has the wrong server settings for NTP or there is something wrong with the NTP.

System restart

This event indicates when the unit has been restarted. You can see when the unit was turned off (the event becomes active) and when the unit started again (the event becomes inactive).

System update

The system has been updated.

12 Data logs

Logs are history of what has happened in the system, and are used to create statistics. This chapter will explain how to create and edit logs.

Logs are created under channel settings both in the **graphical programming** and under the menu **Configuration, Applications & resources**.

12.1 Types of logs

Type	Description	Interval
Instantaneous	Each log point contains the instantaneous value at that time.	1s, 2s, 15s, 1min, 5min, 15min, 1h, 24h, 1 month
Smart	The smart log has per second resolution closest in time, but compresses (spreads out) older log values by calculating averages. This allows long history (from the commissioning of the installation) with lower memory usage. The smart log is for example useful when logging temperatures where a long history is required.	Variable
When changed	A log point is created every time the value changes. Used when logging changes that happen occasionally, for example a light switch.	Variabel
Change	This type of log shows the difference in value since the previous log point. For example used when logging daily or monthly consumptions.	1s, 2s, 15s, 1min, 5min, 15min, 1h, 24h, 1 month

Type	Description	Interval
Max/Min	Each log point consists of the max or min value since the previous log point. The min and max values are calculated as a rolling average with per second resolution.	1s, 2s, 15s, 1min, 5min, 15min, 1h, 24h, 1 month
Mean	Each log point consists of the mean (average) value since the previous log point. The mean is calculated with per second resolution.	1s, 2s, 15s, 1min, 5min, 15min, 1h, 24h, 1 month
Sum	The log sums the values since the previous log point. This is done with per second resolution. The sum log can be used for example when calculating operating time.	1s, 2s, 15s, 1min, 5min, 15min, 1h, 24h, 1 month

Note that all logs except for smart log are implemented as circular buffers. This means that older log values will be rotated out of memory when the buffer is full. There is a reserved memory for each log area, which is not affected by the other logs. For example; the contents of the long term log are not affected by the short term log filling up and rotating out old log values. The exception is the smart log where older values are not deleted, they are instead converted to longer intervals.

These are the log areas:

Log area	Contents
Smart	Smart logs
Short term	Periodic logs with interval < 1h
Medium term	Periodic logs with 1h < interval ≤ 24h
Long term	Periodic logs with interval ≥ 1h
Change	Change logs

Log area	Contents
When changed	When changed logs

12.2 Create logs

1. Go to a channels settings (in the **graphical programming** or under the menu **Configuration, Applications & resources**).

2. Click on **Add** to add a log. You can have different types of logs for the same channel.
3. Choose **type** of log, set **range** and **offset**.
4. Click **Save**.

12.3 View logs

Data logs are used for viewing plots of historical data for log points (for example channels or parameters). A view can be saved to be opened later. It is also possible to configure sendouts for saved views.

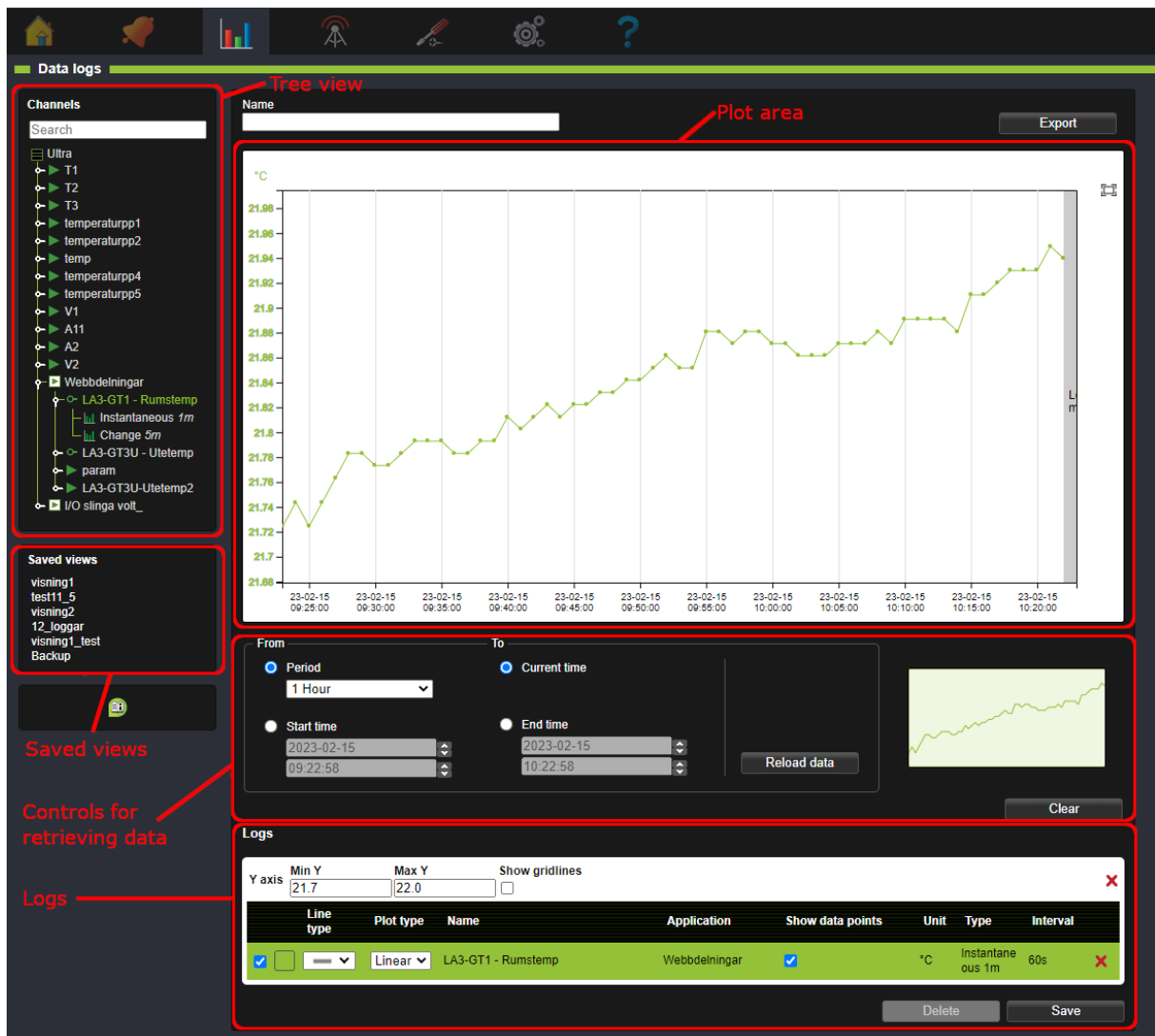

Treeview: Displays log points that can be added as logs. Only channels and parameters that have logging enabled can be displayed in data logs. This is done in the settings for each channel.

Plot area: The area where plots for the logs are displayed.

Controls for retrieving data: Settings that control the time period for which data is displayed.

Logs: List over the log points that are added as logs in the plot.

Saved views: List of saved views.

12.3.1 Add a log to a plot

A log point is added by drag-and-dropping it from the tree view to the plot area. The log will be added with its own Y-axis. Maximum 10 Y-axis can be added. Note that logs with short log intervals (for

example per second logs) can take a long time to load for long time periods.

To add a log to an existing Y-axis, drop it directly on that axis in the plot area. When a log is added to a plot it is also listed under **Logs** below the plot area.

The Y-axis may use SI-prefixes when displaying very large and small values. For example:

μ micro (0.000 001)

m milli (0.001)

k kilo (1 000)

M mega (1 000 000)

12.3.2 Selection of time period

Controls for retrieving data below the plot area controls which time period the plot displays. To change the time period, select the desired settings and click **Reload data**. If period is set to **Auto** and a log is added, the x-axis will automatically be scaled to suit the type of log. If the selected time period contains a large amount of measurement points the loading can take a long time. To abort, click **Stop loading**. New settings can then be selected with a shorter time period, or fewer measurement points.

The miniature image shows an overview of the selected time period. Current zoom level is displayed as a shadowed area in the miniature image.

The button **Clear** removes all logs that are currently displayed in the plot area.

12.3.3 Logs

Logs displays a list of all the Y-axis and which logs are under each Y-axis.

Min Y and **Max Y** controls the min and max values for the Y-axis in the plot area.

Show gridlines controls whether gridlines are displayed or not.

Show data points controls whether data points are displayed or not. Data points cannot be displayed for logs with a large number of data points.

The checkbox next to each log controls whether the log shall be visible or not.

A Y-axis with more than one logs will have the same unit and colour as the currently selected log. Click on a log to select it.

Line type and **Plot type** controls the appearance of a log in the plot.

Clicking the red crosses  removes a Y-axis (with all its logs) or an individual log from the view.

12.4 Zoom and pan

12.4.1 Zoom with mouse wheel

The mouse wheel can be used to zoom in or out in the plot. If the mouse cursor is over the plot area and the mousewheel is scrolled both the X- and Y-axis will be zoomed. If the cursor is over a specific X- or Y-axis, only that axis will be zoomed.

12.4.2 Zoom with selection

Right click and drag in the plot area to select an area to zoom in on.

12.4.3 Pinch zoom (only works with touch screen)

If a touch screen is used pinch zoom can be used to zoom in the plot. Pinch with two fingers to zoom in or out in the plot.

12.4.4 Reset zoom

Use the button reset zoom  to reset the zoom to display the whole plot in the selected time period.

12.4.5 Pan

Click and drag in the plot area to pan. Click and drag an individual axis to pan only that axis.

12.5 Tooltip

When the mouse pointer is hovered over the plot a tooltip is displayed.

- If the pointer is over a data point the name, value and timestamp of the data point is displayed. The data point is marked in the color of the log.
- If the pointer is between data points the name, an interpolated value and its timestamp is displayed. The interpolated point is marked in black.

12.6 Saved views

A saved view saves the current view of one or more logs so that the same view can be opened later.

Saved views are also used for log sendouts, see chapter Log Sendouts

12.6.1 Create saved view

To save the current view, enter a name for it and click **Save**. The saved view will then be displayed in the section **Saved views**. Saved views with sendouts are indicated with a letter symbol .

A saved view stores:

- Which logs are included in the view, and which Y-axis they are connected to.
- Line colour, Line type and Plot type.
- Selected log (determines unit and colour of the Y-axis).
- Which logs are selected to be visible (determined by the check box)
- Time period settings in **Controls for retrieving data**

12.6.2 Delete saved view

To delete a saved view, first open it by selecting it in the list. Then press the button **Delete**. A saved view with sendouts cannot be deleted. In that case the sendout must first be removed. See chapter Log Sendouts.

12.6.3 Modify saved view

To modify a saved view, first open it by clicking it in the list. It can then be modified, for example by adding or removing logs. Then click **Save**. Note that modifying a saved view with sendouts also affects the sendouts.

12.6.4 Export data

The button **Export** above the plot area allows exporting the currently viewed logs in CSV-format.

12.7 Log sendouts

Here you can export a log based on your **saved views**.

IMSE UltraBase30 0 0 Module name Module address 2015-06-18 13:47:34 Abelko INNOVATION Log out: config Logged in users: 1

Log sendouts

Data logs	Recipients	Contact information	Edit	Delete
Undercentral A				
	Jessica	jessica.rohdin@abelko.se		
Framledning Undercentral A				
Manuell växling 1 + drift				
Framledning 1				
VV reglerfel				

1. Add a new recipient next to the log you want to export.

New log recipient

Recipients
 Jessica ▾

▲ Create new recipient

Name

Email

Mail host
 Abelko intern ▾

Create new

Cancel Add

2. Select an already existing recipient (these are created under the menu **Communication, Sendouts**) in the drop down menu or create a new by entering name and contact information. **Mail host** is mandatory since all email recipients need to be tied to an email server. If you don't have any mail hosts here you need to fill the settings under the menu **Communication, Mail host**.
3. Click **Add**.

Edit ✖

Name

Period time [minutes]

Offset [minutes]

4. When you have the recipients click **Edit** for a **Data log**.
5. Set **Period time** (how often you want it to be sent) and an **Offset** if needed (how far into the period time you want the transfer to take place).
6. Click **Save**.

The first time, it will send all the data. After this, it will remember what it has sent and only send new data (all data collected after the last transfer).

Below is an example of a log sendout.

```

DUC Apartment 4, Abelko house, Luleå
00-30-5E-0B-01-8C
1, Database log
Index      1          2          3          4
Channel number 77      10      11      12
Channel name  GT20 [mean]  GT21 [mean]  GT22 [mean]  GT23 [mean]
Channel unit   °C      °C      °C      °C
2015-07-04 14:54:00      20.881987      20.620169      20.076967      18.460488
2015-07-04 14:55:00      20.881661      20.620006      20.081535      18.458369
2015-07-04 14:56:00      20.881008      20.622453      20.079088      18.459184
2015-07-04 14:57:00      20.883946      20.620658      20.077946      18.458695
2015-07-04 14:58:00      20.882803      20.622779      20.078761      18.459347
2015-07-04 14:59:00      20.885578      20.623106      20.078598      18.460488
2015-07-04 15:00:00      20.885741      20.623758      20.07974      18.459347
2015-07-04 15:01:00      20.887047      20.626043      20.082025      18.460162
2015-07-04 15:02:00      20.887863      20.624574      20.081698      18.460162
2015-07-04 15:03:00      20.889822      20.626859      20.083167      18.460488
2015-07-04 15:04:00      20.891127      20.626206      20.080882      18.45951
2015-07-04 15:05:00      20.890801      20.627185      20.081698      18.461139
2015-07-04 15:06:00      20.890474      20.627185      20.079577      18.459347
2015-07-04 15:07:00      20.891454      20.627185      20.078761      18.458858
2015-07-04 15:08:00      20.890474      20.627185      20.079903      18.459999
2015-07-04 15:09:00      20.890801      20.62849      20.080719      18.459184
2015-07-04 15:10:00      20.89178      20.628164      20.079251      18.456088
2015-07-04 15:11:00      20.891454      20.628817      20.080393      18.457555
2015-07-04 15:12:00      20.893412      20.629796      20.081698      18.457555
2015-07-04 15:13:00      20.895371      20.630612      20.082514      18.458369
2015-07-04 15:14:00      20.895371      20.630938      20.083983      18.458858

```

At the top you can see from which device the mail comes from, with name and MAC address. You can see what type of log it is (1, database log) and below that, all channel numbers and channel names

with units are listed. Under these you can see a timestamp and which value the channel had at that time. There is not always data for each time point for each channel.

13 Inputs & Outputs

In this chapter, you will learn the principle behind inputs and outputs. We will explain how to connect them on the physical unit and also how to configure them in the web interface.

13.1 Overview

For the device to be able to work, you must first connect the different types of sensors and actuators. These are connected to inputs and outputs and are represented in software by I/O channels. An Ultra has its own inputs and outputs, and the number of inputs and outputs can be expanded by attaching expansion modules. Both the expansion modules and the Ultra are represented as I/O units. I/O units and I/O channels are configured under the software menu **Configuration, In- & outputs**.

Expansion modules are modules that you plug into an Ultra via ready-made modular cables on a special bus. They are a part of the product line and work the same way as the base units I/Os. They are designed to be mounted in the same cabinet as the base unit. Up to ten units can be connected, and they have cable sequence detection that detects the order in which they are connected. Cable sequence number is used to address the device, but you can also use the serial number as the address.

If **Ex OUT** is configured to be used for **External units**, the text **RS485 Ex is used by external units** is shown.

In- and outputs can also be connected via **external units**, which communicates via Modbus or other protocols. You can read about this in more detail in Chapter External units.

13.2 Details Inputs and Outputs

For more detailed information on the different types of inputs and outputs, see respective device's installation chapter. For more detailed information on the different types of inputs and outputs on expansion modules, see Refererensmanual IMSE Expansionsmoduler.

13.2.1 Universal Inputs

Select the desired function using the wrench icon. 

The status channel of the Universal input can have the following values:

- 0 = Ok (for all types).
- 1 = Out of range low (only for current- and voltage input).

- 2 = Out of range high (only for current-, voltage- and digital input).
- 3 = Short to ground (only for temperature input).
- 4 = Open circuit (only for temperature input).

13.2.2 Digital Inputs

Digital status, frequency measurement and pulse counter is available on different channels and can be used simultaneously.

Additional signals for every digital input:

- Reset counter: the counter value is reset with button in Edit I/O-Channel settings
- Reset overflow flag: set value to one to reset overflow flag (only available on external units)
- Counter overflow: indicates that the counter has passed $2^{32}-1$ and reset to zero

13.2.3 Analog Outputs

Analog outputs on expansion modules can be controlled manually with a switch on the front. The signal **Manually overridden** indicates if manual override is active. If the output is not controlled manually the signal **Manually overridden** is minus one. Otherwise, if it is zero or greater, it shows that the channel is manually controlled, and to which value.

13.2.4 Digital Outputs

Digital outputs on the expansion modules can be controlled manually with a switch on the device. For such digital outputs there is an input called **Manually overridden**, showing if manual control is enabled on the device. If the output is controlled by the signal DO, **Manually overridden** is zero. If the output is manually set to on, the signal is one, if the output is manually set to off the signal is two.

13.3 Configure Sensors and Actuators

Edit all of the units inputs and outputs under the menu **Configuration, In- & outputs**, including expansion modules if any.

The control unit is located at the top of the page.

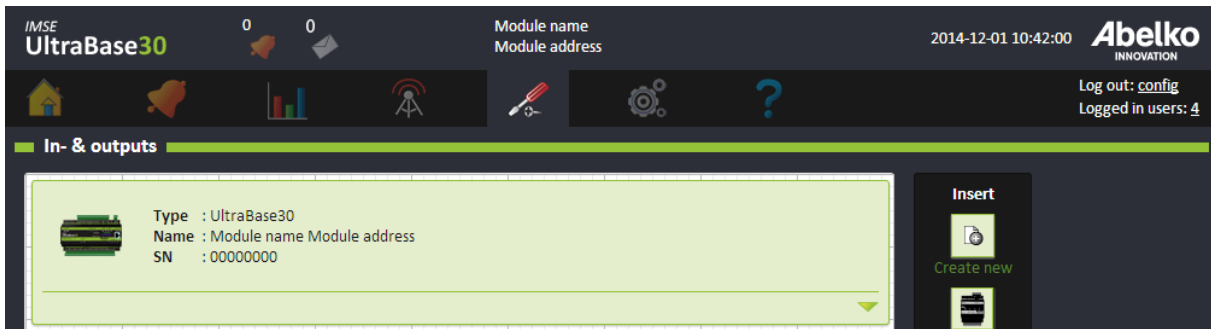

1. If you extend an unit, you can see all of the inputs and outputs.

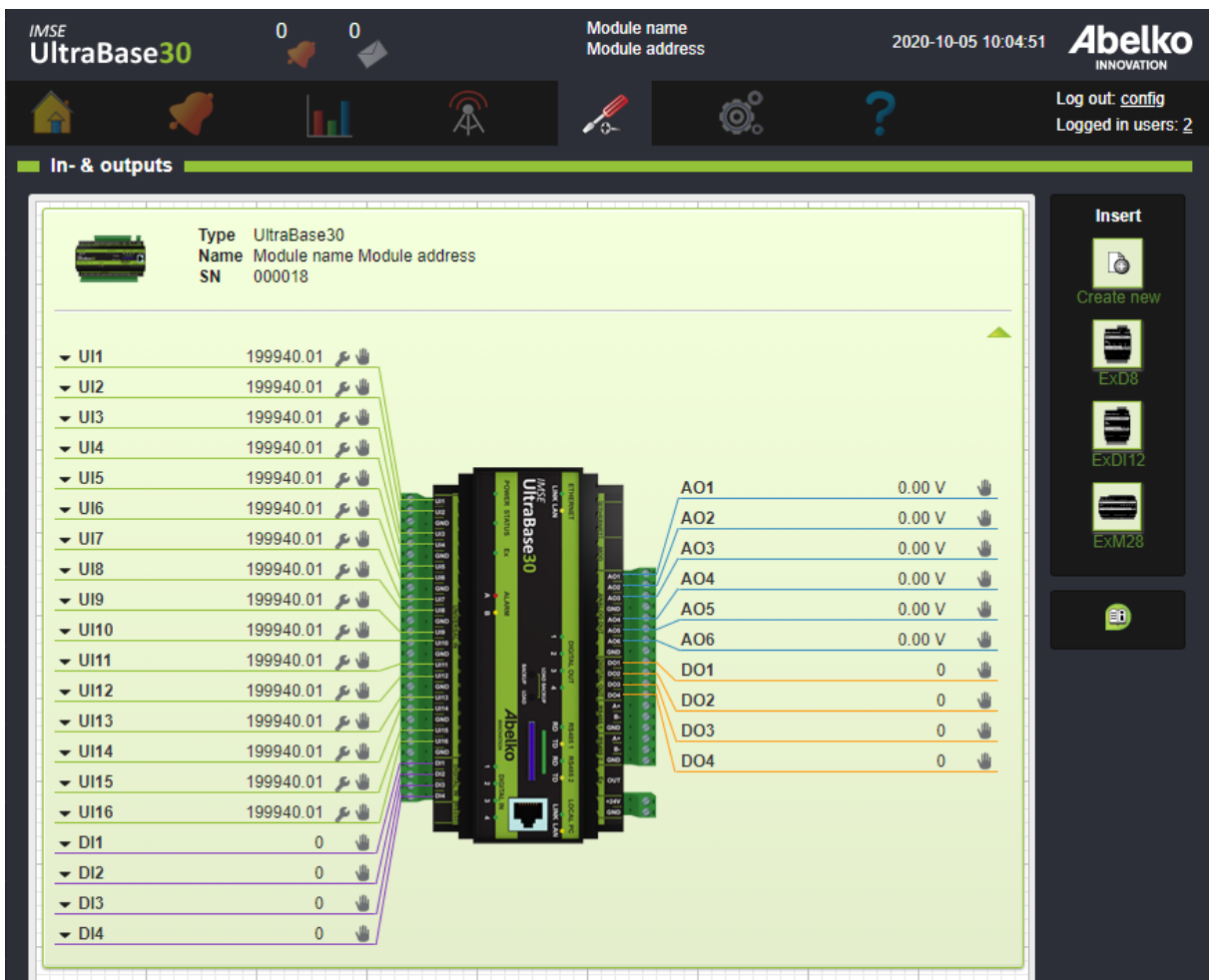

2. Click on the inputs and outputs **placement names** (ex. UI1) to change their settings (number of

decimals, unit, scaling etcetera) .

3. A **small arrow** next to the placement name indicates that you can use the same input multiple times, measuring different types of values. Click on the arrow to change their settings.

 This icon means that there are settings concerning the input/output itself. For universal inputs, select if you want to measure resistance, voltage, current or digital status.

 : This icon means that the channels can be controlled manually (manual override).

13.3.1 Configure Expansion Modules

You can configure expansion modules in two ways. First, by connecting the expansion modules and then editing their settings once they appear in the web interface. Or second, by preconfiguring the expansion modules before they are connected to the UltraBase; if you preconfigure them, prepare the modules in the same order you want them to be connected physically.

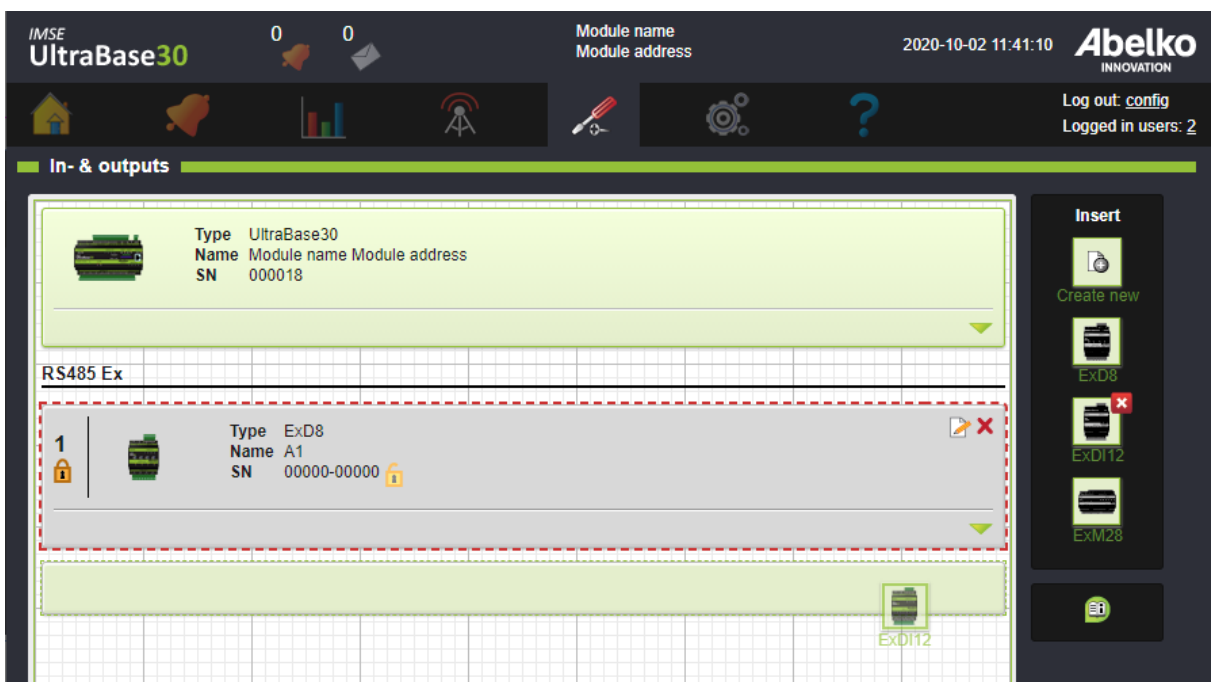

1. Drag-and-drop modules from the Insert menu into the workspace. When you drop the module, it will appear as a block in the list.

- The modules are numbered in the order you place them in the list. This order represents the order that they should be connected physically to the base unit. You can easily change the order by dragging-and-dropping the blocks up and down in the list.



- Lock** the modules to a **cable sequence number** and/or a **serial number** so they can be used in the system. White background and a grey frame means that you have not yet locked the module. When you preconfigure an Ultra, you lock to the cable sequence number. If the correct type of module is located in the right position, everything will work properly. When the module is connected, lock to the serial number; that way the connection is also locked to a serial number and not only to a certain position. This is preferable as it reduces the risk of confusion.

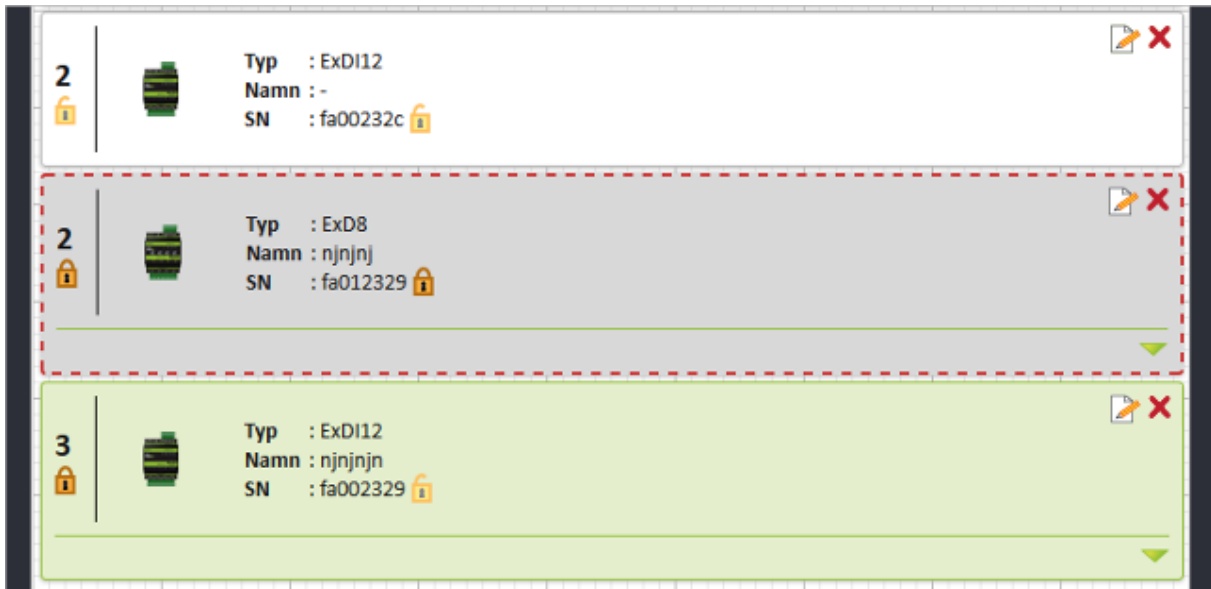

- When you physically connect the modules to the base unit, their positions must be matched to the order you prepared the modules for. If there are any mismatches, the software blocks for the modules will turn grey with a red dotted frame. To correct mismatches, reorder the modules by moving them in the list or change the serial number of the blocks in the interface.
- If you try to connect a module unfamiliar to the system, you will be unable to make any settings for it and only view it in the list. In order to be able to use it, you must upload a communication script for this unfamiliar module.

13.4 Replacing an Expansion Module

If an expansion module is broken and needs to be replaced, it can be done if it is **only locked on position**.

1. Switch the power off of the system.
2. Insert a new module of the same type in the same position (connect in the same order as before in the Ex strand).

When the system is switched on again, the new module has replaced the old one.

If you have **multiple external devices of the same type**, it is safest to lock them both in position and serial number. Then they will not be mixed up if someone switches the order. Unlock serial number if any device needs replacing.

A device can not be deleted if its channels are linked in graphical programming. To delete an external device, remove the lock both on serial number and position.

14 External Units

External units are different kind of units that the Ultra can exchange information with as the master unit on field bus communication protocol. They can be used for more inputs/outputs, indicators and communication with other systems. This chapter will explain how to add new devices and how to access an overview of available units in the system.

To add, remove or move external units edit mode must be enabled by clicking the button **Enable editing**.

Edit external unit

Name: Module 3 Address: 1

Baudrate: 38400 Number of bits: 8 Parity: None Stop bits: 1 Timeout [ms]: 300 Character timeout: 4

Premessage delay [ms]: 1.042

Modbus register

Register	Name	FC	RW	Type	Scale	Update interval	Value	Unit	
5	AO1	16	W	Int 16	100	1 s	0.0	%	✗ ▼
6	AO2	4	R	Int 16	100	1 s	1.0	%	✗ ▼
7	AO3	16	WoC	Int 16	100	1 s	90.0	%	✗ ▼

Add

Upload: Browse... Export: JSON CSV

Close Save

External units inputs and outputs can be used in the Graphical programming.

The UltraBase20 has one **RS485**-port and one **M-bus** mini master port. The UltraBase30 and UltraBase40 has two **RS485** ports that can be used for external units.

The EX-Out port can also be configured to be used for **External units**, then you will for example need an ExConnect. These settings is found under **Communication**. The actual setting for that port is then made under **External units**.

IMSE UltraBase has special support for the Modbus protocol. By using script definitions other protocols can also be used like Genibus, Danfoss FC and other master slave protocols using RS485. If you connect devices via a level converter, even more protocols can be handled. With for example an IMC10,

UltraBase30 and UltraBase40 can communicate with M-bus devices. The UltraBase20 has a built in M-Bus mini master port.

There is special support for **Modbus TCP** by configuring Modbus TCP gateways. These are configured on the page **Modbus TCP gateway** (see section Modbus TCP Gateway for more details). A gateway functions as a separate communication port on the page and translates Modbus communication to Modbus TCP. You can define communication with Modbus slaves without writing scripts (this is described in section Configure external Modbus units).

14.1 Configure External Units with definition scripts

To the right, there is an palette with all external unit templates that you have script for.

1. Click **Create new** to upload a new type definition. Select a type definition from files that have been uploaded to the folder **Communication definitions** on the page **File manager** or **Upload** a new file. You can get type definitions from abelko.se. Type definitions written for IMSE Web-Master Pro are also compatible. The **IMSE Ultra Script Language Reference manual's** chapter on GFBI script describes how to create custom type definitions.

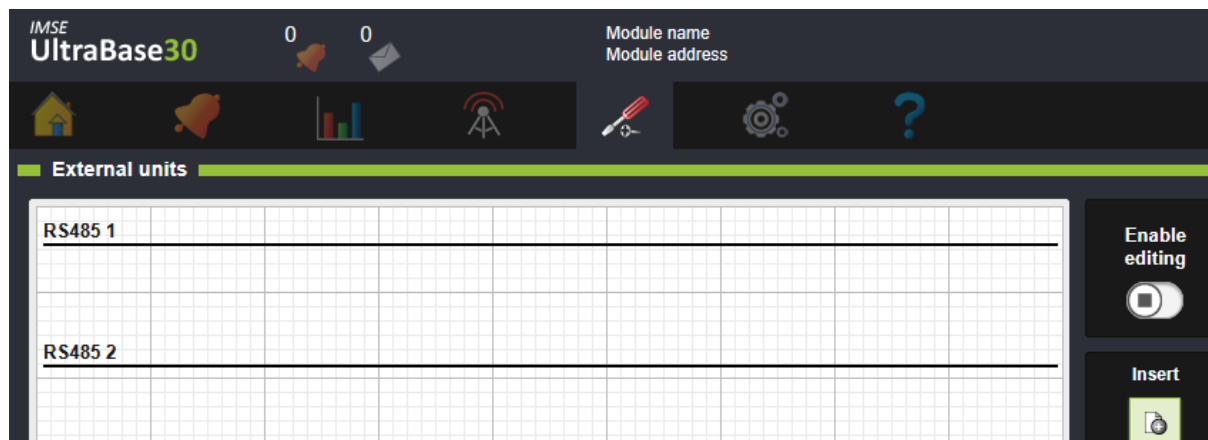

2. Drag-and-drop the template onto the workspace. Place it under any container, e.g. **RS485 1** or **Modbus TCP Gateway**. It is also possible to move the units between these containers afterwards by dragging and dropping them.

Edit external unit

Name
Seneca 1

Baudrate: 38400 | Number of bits: 8 | Parity: None | Stop bits: 1 | Character timeout: 4 | Premessage delay [ms]: 1.042

Telegrams

Name	Update interval	Message timeout [ms]	Updated: -
Read Inputs	1 s	300	

Clear communication statistics

Clear

Close Save

3. Name the unit and select **Baudrate**, **Number of bits**, **Parity** and **Stop bits**. Default values is retrieved from the communication script.
4. **Character timeout** is the time for the number of bytes that the buss must be idle before the Ultra starts to decode the incoming answer.
5. **Premessage delay (ms)** is the time the Ultra will wait between the previously received answer and the new message. The previously received answer can be from another, or the same unit on the same bus. Default value is calculated from the current baudrate and character timeout.
6. Set **Update interval** and **Message timeout** for the telegrams. **Message timeout (ms)** is the time the Ultra will wait for an answer from an external unit before setting timeout. To set the same update interval for all telegrams, click on the column title **Update interval** and set the time for any telegram.
7. Click **Save** and **Close**.
8. The **Edit** icon edits the unit. You open the block by clicking on the arrow to see the unit's inputs and outputs.
9. The unit is by default off when created. Click on the unit's start/stop button to activate it. If the unit is connected and configured correctly, the block will turn green. However, if something is wrong, the block will turn grey with a red dotted frame. Check that the external unit is correctly connected and has the appropriate settings. If there is something wrong with the telegrams a warning symbol will be shown.

The unit's inputs and outputs can be connected in the Graphical programming even before it is connected.

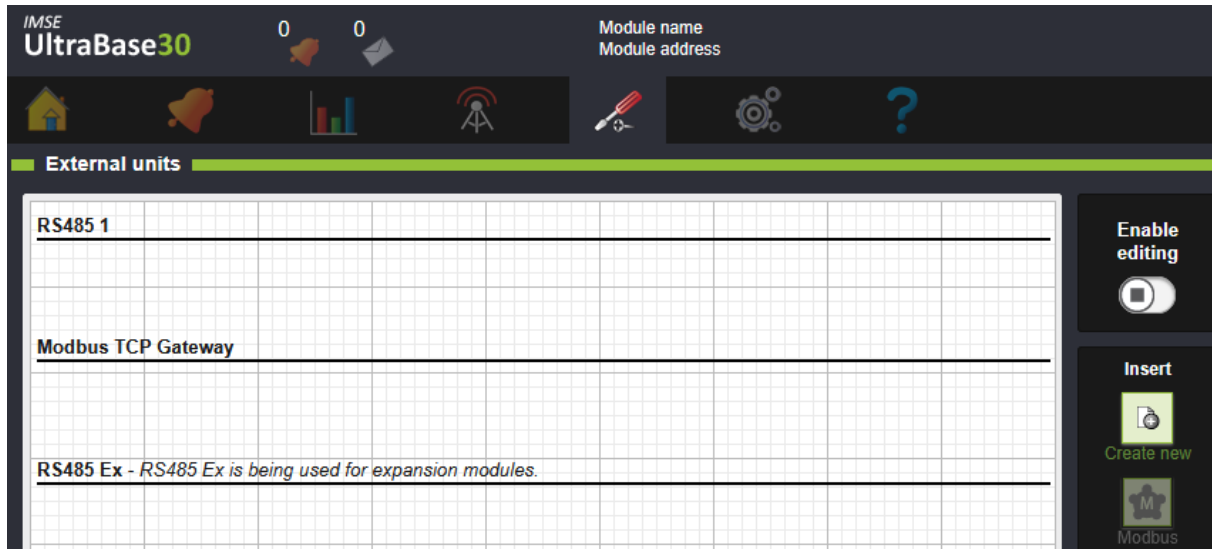

One RS485 port (for UB30: **RS485 1**, for UB20 and UB40: **RS485 2**) can be used by **Modbus RTU** (this is a setting under the menu **Communication, Modbus slave settings**). When Modbus RTU is activated for the port, it cannot be used for external units, and will not be displayed.

External units located under **Modbus TCP Gateway** send their telegrams to an external unit in a shared communication queue. It is also possible to create Modbus units using separate communication queues. These are shown as own headings starting with **Modbus TCP** followed by the units name and IP address. Only external units using the Modbus protocol works with a Modbus TCP gateway. You can create and edit gateways under the menu **Communication, Modbus TCP Gateway**.

14.2 Configure external Modbus units

1. Create a new Modbus unit by dragging and dropping the Modbus type symbol from the palette to the right into the workspace. You can place it under **RS485 1**, **RS485 2**, **Modbus TCP Gateway** or any separate **Modbus TCP** holder. It is also possible to move the units between these holders afterwards by dragging and dropping them.
2. **Name** the unit and enter the **Modbus address**. Click **Save**. Keep in mind that when using **Modbus TCP Gateway**, there must be a shared communication queue gateway configured to handle the unit's address. For more information, see section 18.6 Modbus TCP gateway.

- Now you can edit the unit. Set which **Baudrate** it communicates on and adjust other communication settings if necessary. Set the message time out **Timeout [ms]** for the unit. The slave unit has a maximum time it can take to answer. The time out you set here must be at least as long, otherwise the units may try to communicate at the same time.

Edit external unit ✖

Name: Address:

Baudrate: Number of bits: Parity: Stop bits: Timeout [ms]: Character timeout:

Premessage delay [ms]:

Modbus register

Register	Name	FC	RW	Type	Scale	Update interval	Value	Unit	
5	AO1	16	W	Int 16	100	1 s	0.0	%	✖
6	AO2	4	R	Int 16	100	1 s	1.0	%	✖
7	AO3	16	WoC	Int 16	100	1 s	90.0	%	✖

Upload: Export:

- Click **Add** to add a new register.
- Set which **Registers** you want to read and write. Define a register by entering register number under **Register** and **Name** the register. Enter which function code **FC** to use. Function codes are explained below. Select whether the register is readable (**R**), writable (**W**) or write on change (**WoC**). Set which **Type** of value it is and if the value in the register is **scaled**. Finally, select how often the register should be read or written under **Update interval**. To set the same update interval for all registers, click on the column title **Update interval** and set the time for any register. You can also enter **Unit**, and if it is an output, enter a **Value** that is written.
- When you have added all registers you want to have read and written, click **Save**.
- The unit is by default off when created. Click on the unit's start/stop button to activate it. If the unit is connected and configured correctly, the block will turn green.

14.2.1 Modbus registers

Different manufacturers use different conventions in the documentation of Modbus registers. In Ultra you enter the **register number**. Register number starts with number one, while register addresses starts with register zero. If the unit's documentation uses the register address, add one to get the register number.

It is quite common to add the **function code** as part of the register address. For example, it can say register 40001. This means (usually) register number one, which can be read with function code (**FC**) 4.

14.2.2 Function codes

You can find definitions for the function codes on modbus.org. The Ultra can use following function codes:

FC	Description
1	Read Coils
2	Read Discrete Inputs
3	Read Holding Registers
4	Read Input Registers
5	Write Single Coil
6	Write Single Register
15	Write Multiple Coils
16	Write Multiple Registers

A **Coil** is one bit that you can read and write, a **Discrete Input** is one bit you can read only. **Holding** and **Input Registers** are 16-bit values. Input Registers correspond to inputs and outputs and Holding Register correspond to settings or calculated values. It is common that you do not make a difference between these register types and that function codes 3 and 4 are doing the same, but the manufacturer can also choose to give the function codes separate address spaces so that Input Register 1 and Holding Register 1 are different things. It is also not certain that a slave supports all function codes.

14.2.3 Readable and writeable registers

Depending on which function code is selected the register will be either readable or writeable. If the register is writeable the option **Write on Change (WoC)** is available. Write on Change means that the register will only be written if the value has changed since the last update according to Update interval.

Note that when Write on Change is selected, the value will still be written once after startup of the UltraBase, even if the value was not changed.

14.2.4 Register types and scaling

A register contains 16 bits, thus representing numbers between 0 and 65535. It corresponds to the type **Word 16**. It can also be used to represent numbers between -32768 and 32767, which is the type **Int 16**. In order to communicate numbers with decimals a **scale factor** is often being used. For example, with the scale factor 10, the temperature 12.3 will be transmitted as 123. Set scale factor in the same way whether it is for reading or writing.

Sometimes, 16 bits are not enough to transmit information with sufficient resolution. Then multiple registers can be combined to represent a value. **Int 32** and **Word 32** are using two registers per value. To write this type of value the **function code 16** must be used. It is not standardized in which order the two register should be. **Int 32 WS** and **Word 32 WS** defines values with reversed register order (**WS, Word Swapped**).

There is no standard way to represent floating-point numbers in Modbus. Therefore, there are four types of **Float** to choose from that correspond to different order of the included bytes. All Float types use two registers.

14.2.5 Update time and limitations

Each register line is read or written separately. Each unit is limited to a maximum of ten readings/writings per second. Each time a device wants to communicate, it takes some time and the bus can only handle one request at a time. Therefore, if there are many units, it is not possible to communicate as often as the **Update Interval** setting specifies. Especially if any device is not responding, communication will be slower as the Ultra has to wait the entire **Timeout** to make sure it does not get a response.

If there are more than ten registers on a unit, it can not read/write all in one second, as each unit is limited to ten questions. A Modbus unit is therefore also limited to a maximum of 100 registers. If

you need to read more registers, you can define multiple **External units** and enter the same Modbus address for the same physical unit.

If the bus performance is important, consider using **GFBI script** instead. With a script definition, you can read or write multiple registers in one question, which is more efficient.

If the unit does not answer ten questions in a row, the device gets the status **Failed** and turns gray. The Ultra will not ask more than one question per second until it begins to respond, in order to avoid blocking the bus for other devices.

14.2.6 Export and use templates

You can save a definition of a Modbus unit as a template file on your computer. You can choose the file format **JSON** or **CSV**. To use the template click **Upload: Browse** under settings of a unit and select a saved file.

The JSON format is preferred if you want to save and reuse settings as a template. If you choose CSV instead, you can open the file in Excell and edit it manually.

14.3 Statistics and troubleshooting

here are **Statistics** for the entire unit (expand the menu with the green arrows on a units block), showing the number of questions sent, received answers, timeouts, checksum errors, and incorrect format. You can also see the last time you received a valid reply from the device.

It may also be something wrong with individual telegrams, like when the register number or function code is invalid. The edit window allows you to view statistics for each register individually.

In the editing window there is a button to **Clear communication statistics**.

Bad format indicates that you attempted to do something the unit thinks is wrong, so it sent an exception code back. Make sure the settings for the register is correct. Incorrect settings can also cause the device not to respond at all and you get a time-out.

Bad CRC/checksum is counted only for the entire device. If you get many errors of that type, it may be because the communication cable is bad, that is, too long, badly terminated or exposed to interferences. It may also be because the devices tries to communicate at the same time since they take longer time to answer than the time-out set in the Ultra.

14.4 Status

The external units can have different status that are indicated by the color of the blocks.

- When everything is OK, the block is green.
- If there is something wrong with communication between the master and the external unit, the block turns grey with a red dotted frame.

All external devices, expansion modules, and web sharing have an I/O channel called **Status channel** that can be used in graphical programming to handle if a device stops working. If the channel value is **OK** (= 0), the unit is working. If the channel value is **TRYING** (= 1), the last communication attempt failed. If the communication fails ten times in a row, the channel gets value **FAILED** (= 2) and the unit is considered faulty.

For inputs from external devices, you can choose which value the I/O channel should have before communicating for the first time. You can also choose if you want the channel to get that value if it loses contact later or if it should retain the last received value.

15 Web Shares

Web shares makes it possible to communicate with other devices and systems via network-based protocols. In the basic version only WMSHare is supported, which primarily is created to share values between Ultra or WMPPro. WMSHare can also be used against servers and other systems.

With WMSHare export you can distribute the values of other devices, which retrieves them over the Internet like a normal web page. With the import function, you can retrieve values to your Ultra. Each value has a key which is the name of the value.

15.1 Create an Auto-export

An auto export means that you share values to other units directly without connecting values to an external unit and connections in the graphical programming.

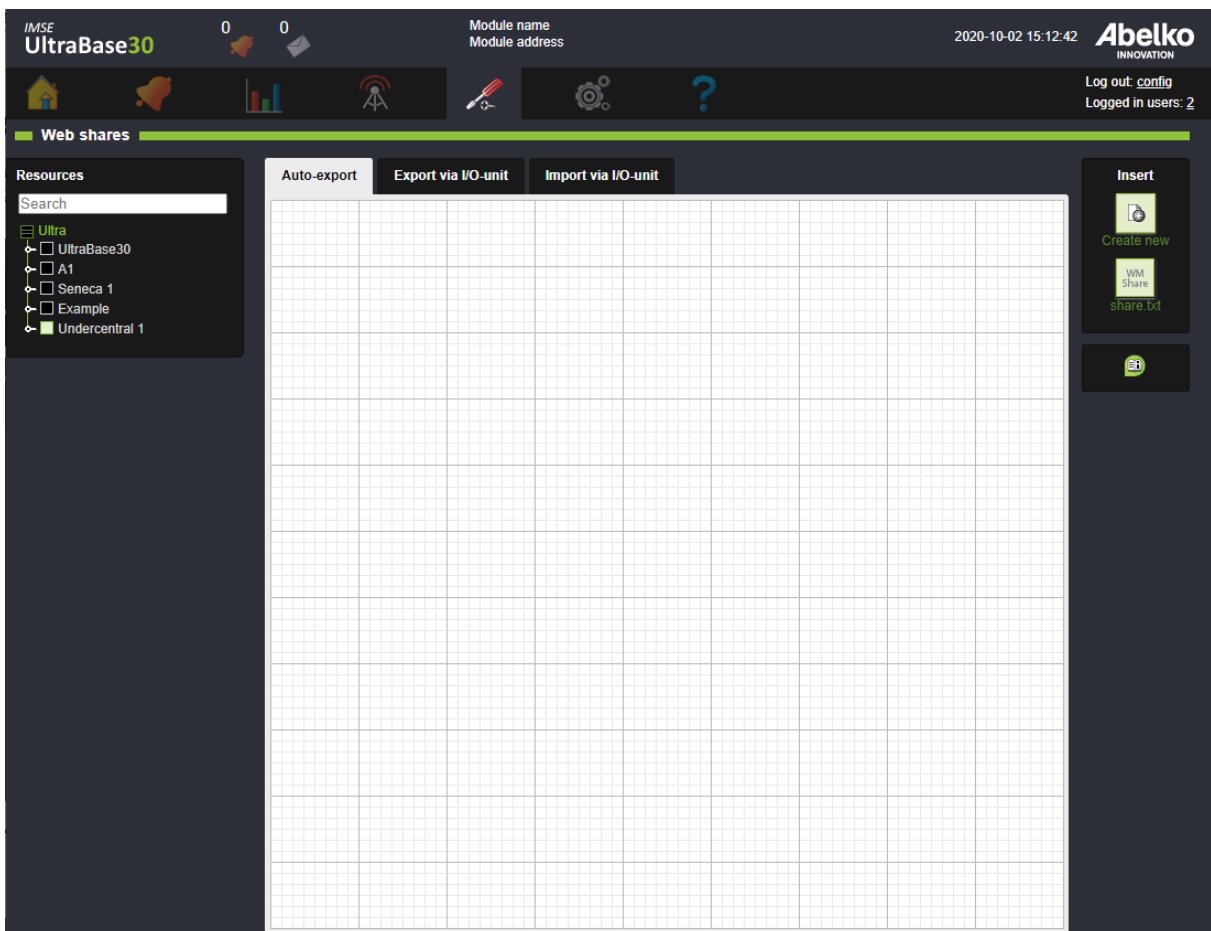

The screenshot displays the IMSE UltraBase30 web interface. The top navigation bar includes the logo 'IMSE UltraBase30', notification icons, and the 'Abelko INNOVATION' logo. The main content area is titled 'Web shares' and features three tabs: 'Auto-export', 'Export via I/O-unit', and 'Import via I/O-unit'. The 'Auto-export' tab is active, showing a large empty grid for configuration. On the left, a 'Resources' sidebar lists a tree view with 'Ultra' as the root, containing sub-items: 'UltraBase30', 'A1', 'Seneca 1', 'Example', and 'Undercentral 1'. On the right, an 'Insert' panel contains buttons for 'Create new' and 'WM Share share.txt'.

1. **Drag-and-drop Create new** from the **insert** menu to the right onto the workspace to create a new auto-export.

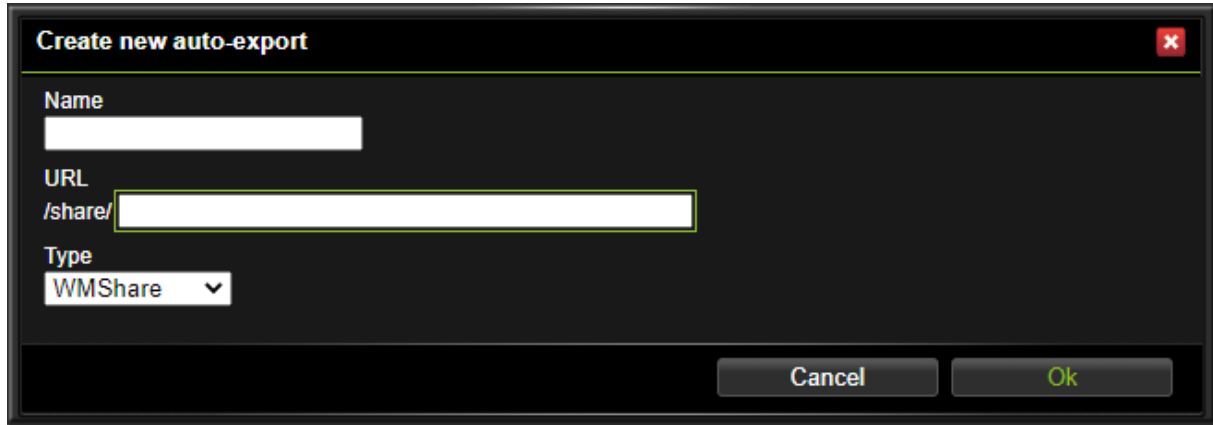

Create new auto-export

Name
[Empty text field]

URL
/share/ [Empty text field]

Type
WMSHare

Cancel Ok

2. **Name** the export. Use underline instead of space since the URL-address will get the same name. Click **Ok**.

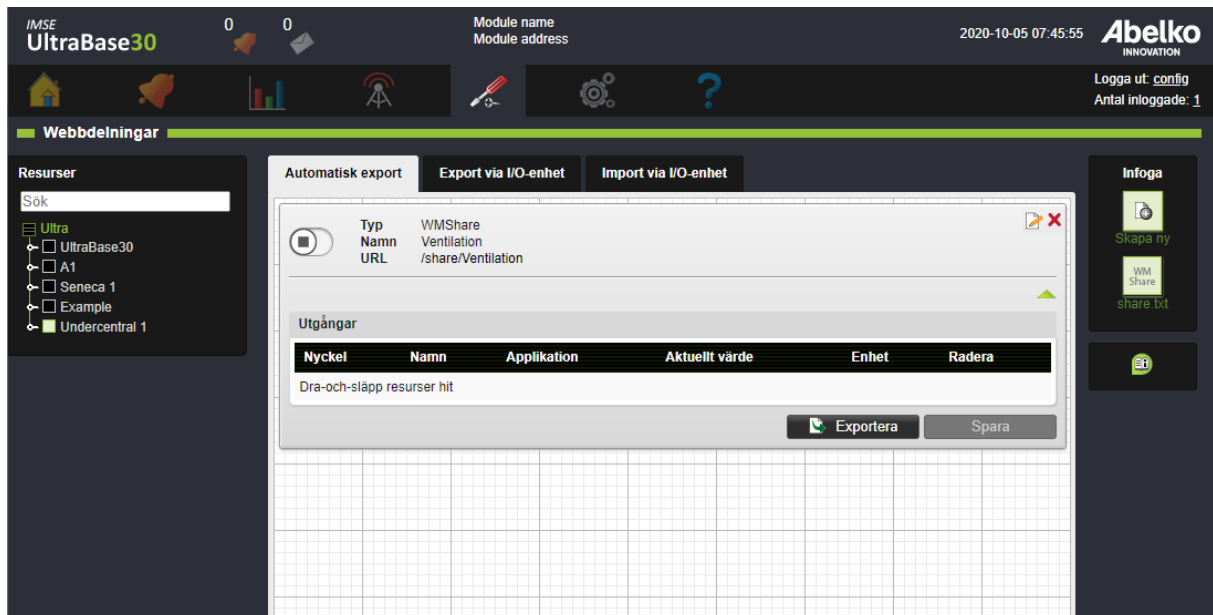

IMSE UltraBase30 0 0 Module name Module address 2020-10-05 07:45:55 Abello INNOVATION

Logga ut: config Antal inloggade: 1

Webbdelningar

Resurser
Sök

- Ultra
 - UltraBase30
 - A1
 - Seneca 1
 - Example
 - Undercentral 1

Automatisk export Export via I/O-enhet Import via I/O-enhet

Typ WMSHare
Namn Ventilation
URL /share/Ventilation

Utgångar

Nyckel	Namn	Applikation	Aktuellt värde	Enhet	Radera
Dra-och-släpp resurser hit					

Exportera Spara

Infoga
Skapa ny
WMSHare share.txt

3. **Drag-and-drop** channels, parameters and more from the node tree to the left onto the area under **Outputs** to add them.

IMSE UltraBase30 0 0 Module name Module address 2015-08-27 13:15

Web shares

- vv Ställdon
- Reglerfel
- Utetemp
- Framledning
- Ställdon 1
- P1 Start
- AKTUELLT_BV
- P2 Driftfel
- P1 Driftind
- P2 Driftind
- P1 Driftfel
- P2_DRIFTFEL
- X
- PID
- Tvillingpump med återkoppling
- PID VV
- W BV max
- W BV min
- Börvärde VV
- VS Aktivering
- Utsignal vid stopp
- Frånslagsfördröjning

Auto-export Export via I/O-unit Import via I/O-unit

Type WMSHare
 Name Automatisk_export_1
 URL /share/Automatisk_export_1

Outputs

Key	Name	Application	Current value	Unit	Delete
VV Ställdon	VV Ställdon	Undercentral A	0	%	X
Framledning	Framledning	Undercentral A	0.0	°C	X
P2 Driftfel	P2 Driftfel	Undercentral A	0		X
P2 Driftind	P2 Driftind	Undercentral A	0		X
P1 Driftfel	P1 Driftfel	Undercentral A	0		X
W BV min	W BV min	Undercentral A	45.0	°C	X
VS Aktivering	VS Aktivering	Undercentral A	1		X
Utsignal vid stopp	Utsignal vid stopp	Undercentral A	0	%	X
Frånslagsfördröjning P1	Frånslagsfördröjning P1	Undercentral A	60	s	X

Export Save

4. Click Save.

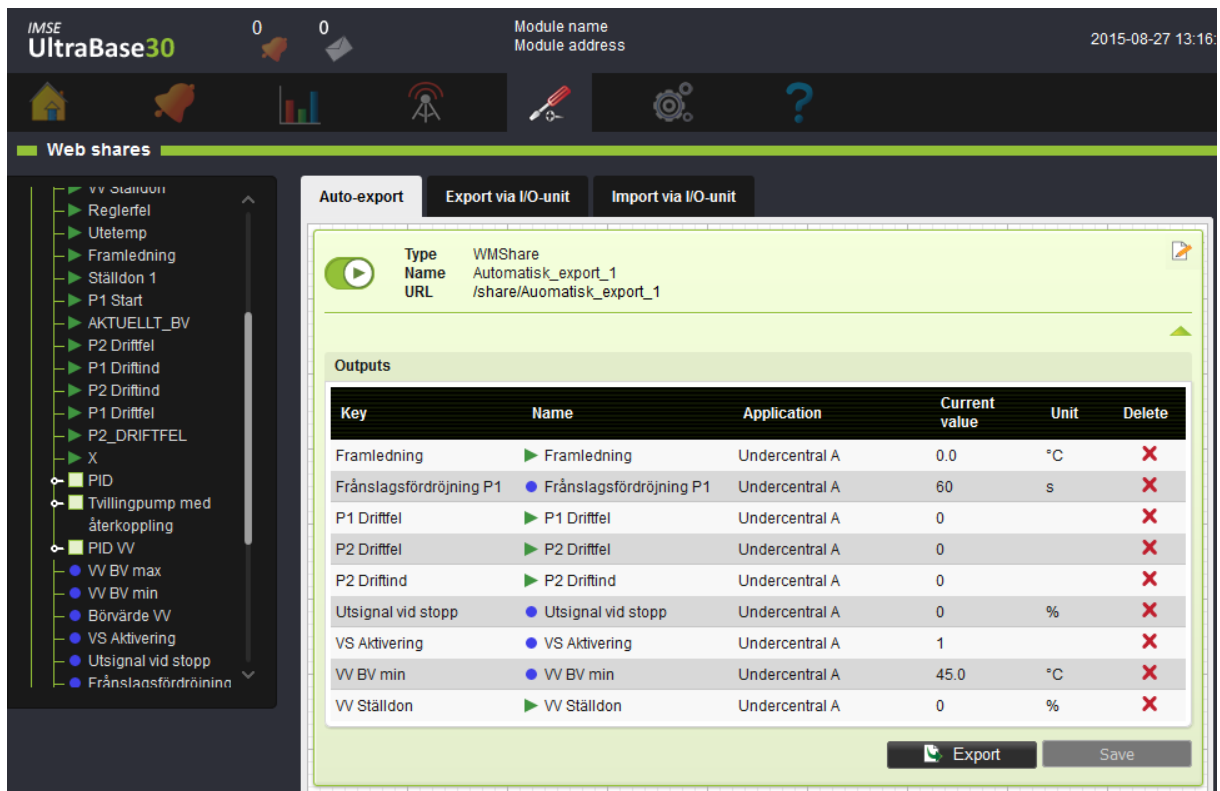

- Click on the status symbol in the upper left corner of the block to **activate** the share. The block turns green with a play symbol.

Now others can use these values by importing the share with the help of the URL address.

If you click on the URL-address an WShare-file opens in a new tab.

As default, the key name is the same as the channel name, but you can click and change the name of the key.

15.2 Create an Export via I/O-unit

Export via an I/O-unit makes it possible to share values, just as an automatic export. The difference is that it will look like an I/O-unit with outputs that you connect in the graphic programming.

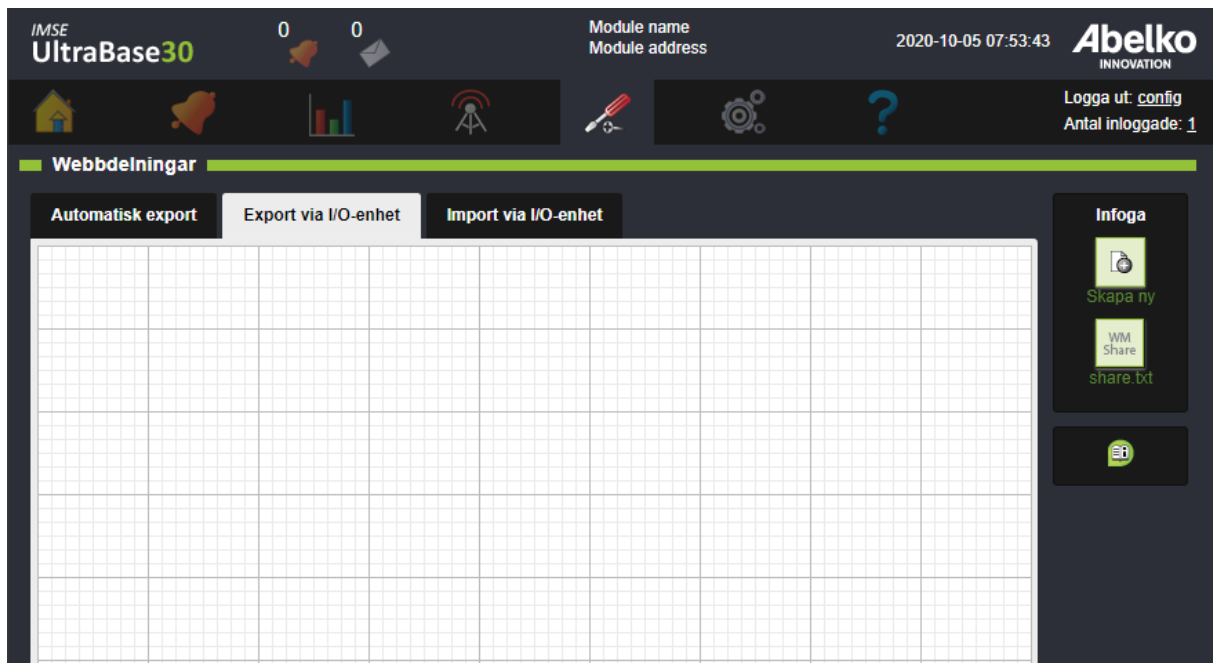

1. **Drag-and-drop** Create new from the insert menu to the right onto the workspace to create a new export.

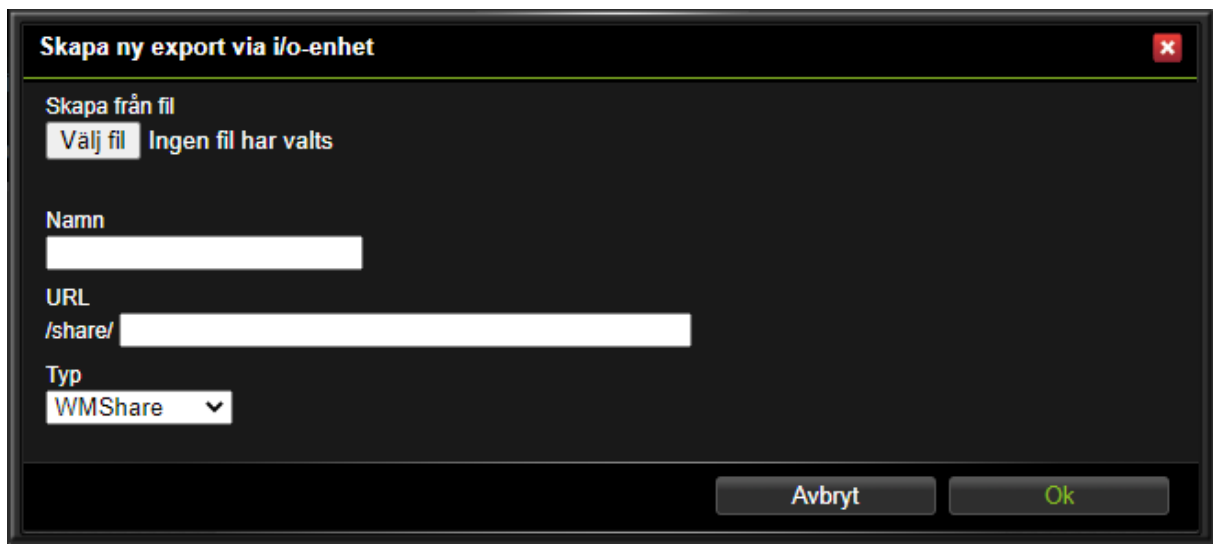

2. Enter a **name** and an **URL** address.

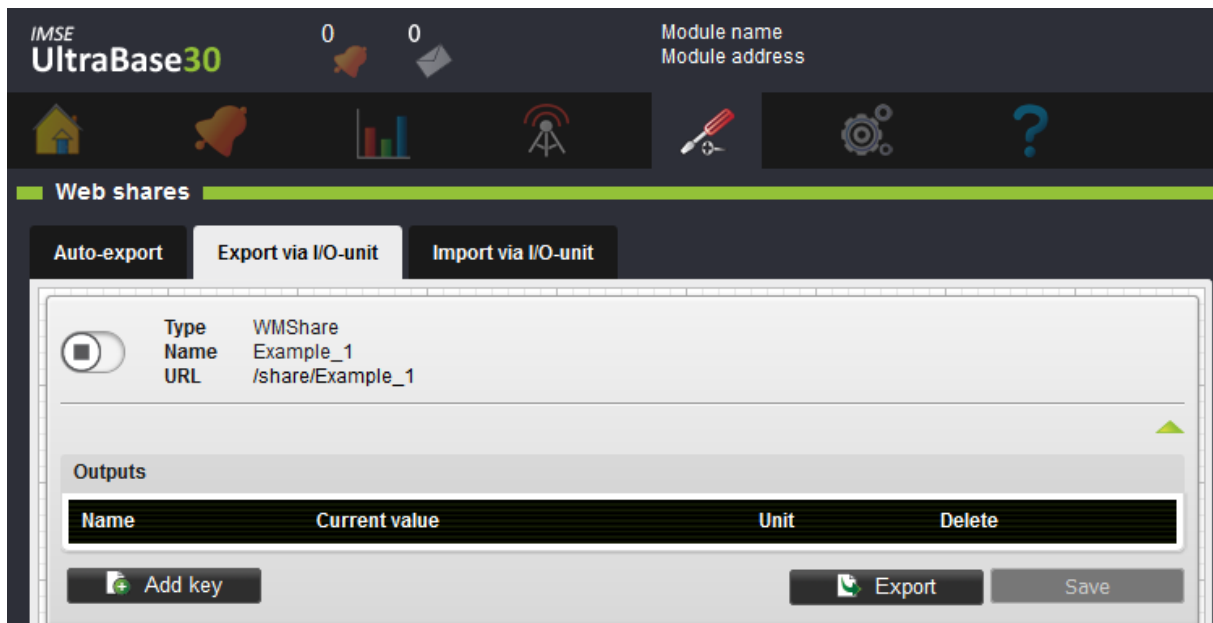

When you create an I/O-unit, you can use a template file. The template file is obtained from the export button in a WMSHare. This will fill in the key names automatically. If you don't have a template file, you can manually fill in the key names later.

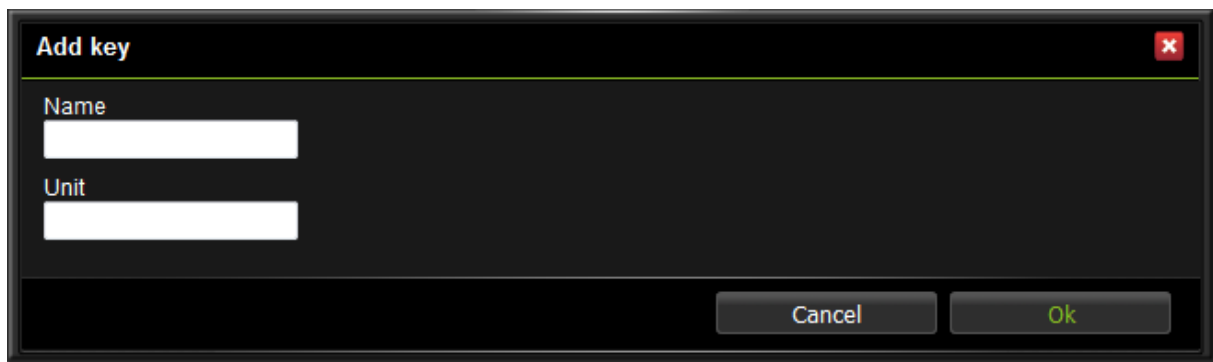

3. Add, delete or edit key names. When you click save, the key names will turn into I/O-channels. The name should not contain å, ä or ö.

IMSE
UltraBase30 0 0 Module name
Module address

Web shares

Auto-export Export via I/O-unit Import via I/O-unit

Type WMSHare
Name Example_1
URL /share/Example_1

Outputs

Name	Current value	Unit	Delete
<input type="radio"/> ExA		C	<input type="checkbox"/>
<input type="radio"/> ExA12		C	<input type="checkbox"/>

4. When you added all the keys, click **Save**.

The screenshot shows the IMSE UltraBase30 web interface. At the top, there is a header with the logo 'IMSE UltraBase30', notification icons, and fields for 'Module name' and 'Module address'. Below the header is a navigation bar with icons for home, notifications, charts, wireless, tools, settings, and help. The main content area is titled 'Webbdelningar' and contains three tabs: 'Automatisk export', 'Export via I/O-enhet', and 'Import via I/O-enhet'. The 'Export via I/O-enhet' tab is selected, showing a configuration block for a WMSHare. The block has a play button icon in the top left corner, indicating it is active. The configuration details are as follows:

Typ	WMSHare
Namn	Export_1
URL	/share/Export_1

Below the configuration details, there are sections for 'Statistik' and 'Information'. Under 'Utgångar' (Outputs), there is a table with the following data:

Namn	Aktuellt värde	Enhet	Radera
<input type="radio"/> ExA	0.0	C	✖
<input type="radio"/> ExB	0.0	C	✖
<input type="radio"/> ExC	0.0	C	✖

At the bottom of the configuration block, there are buttons for 'Lägg till nyckel', 'Exportera', and 'Spara'.

- Click on the status symbol in the upper left corner of the block to activate the share. The block turns green with a play symbol.

Now you can go to graphical programming and connect the external units outputs.

15.3 Create an Import via I/O-unit

In order to import values from another unit, you create an import via an I/O-unit.

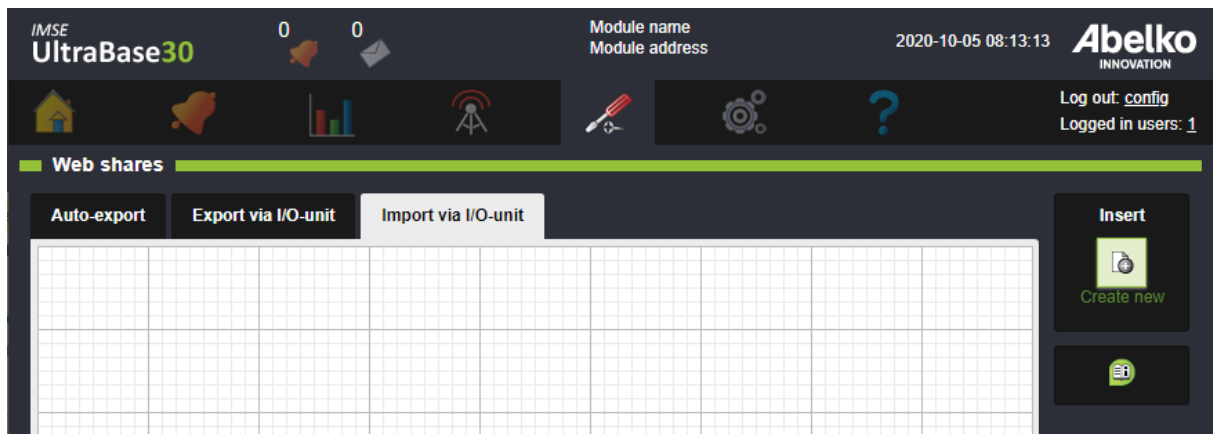

1. **Drag-and-drop Create new** from the **insert** menu to the right onto the workspace to create a new export.

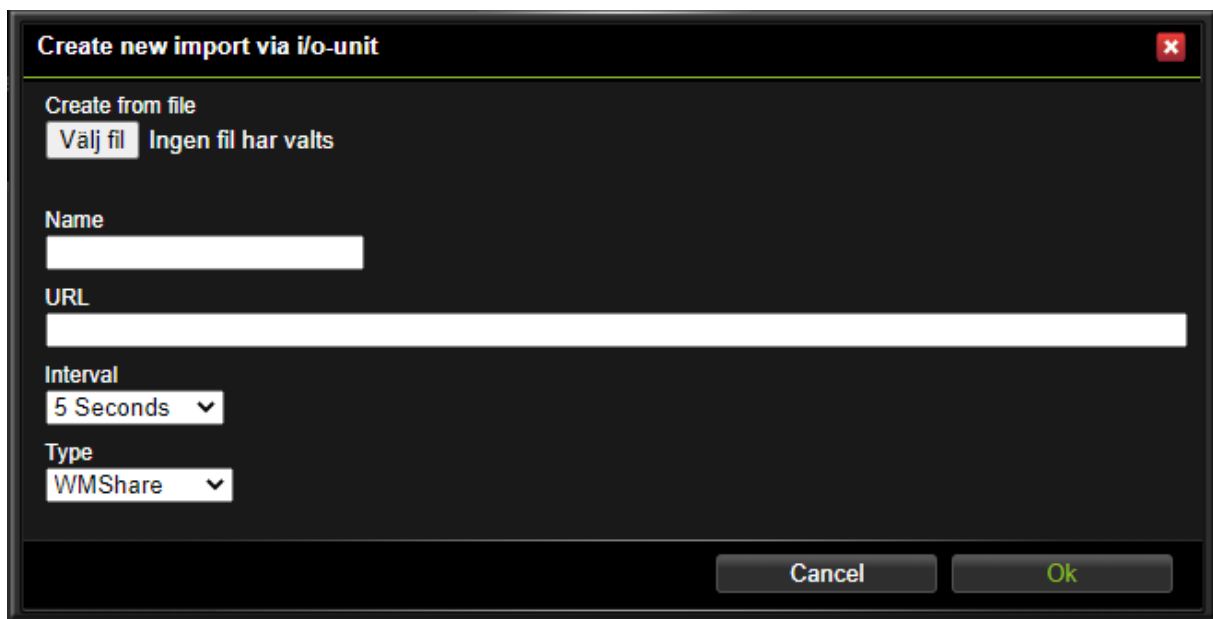

2. When you create an import, **name** the I/O-unit and enter the **URL** address to the share you want to import. Under **Interval**, you set how often you want the values to be updated. Click **Ok**.

If the sharing unit already is running and operating, the key names can be collected from there. Else, you can use a template file. The template file is obtained from the export button in a WMSHare. This will fill in the key names automatically. If you don't have a template file, you can manually fill in the

key names later.

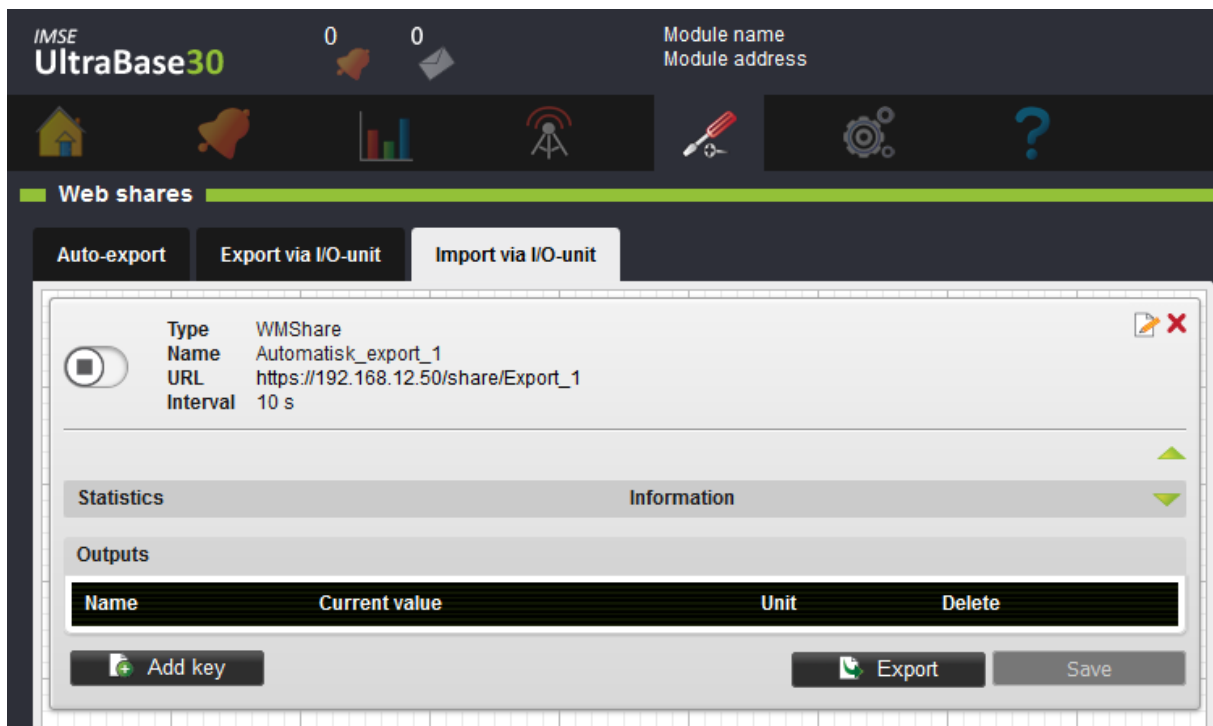

3. Add, delete or edit key names. When you click save, the key names will turn into I/O-channels. The name should not contain å, ä, ö or other special character.

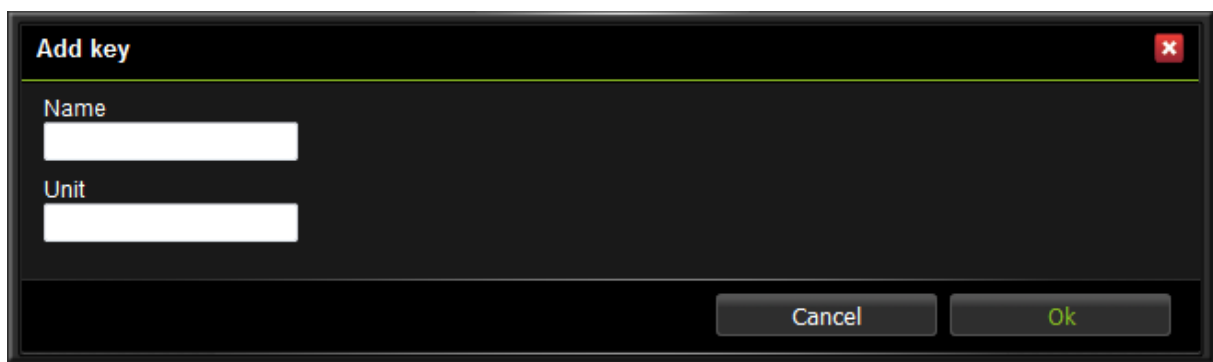

4. When you added all the keys, click **Save**.

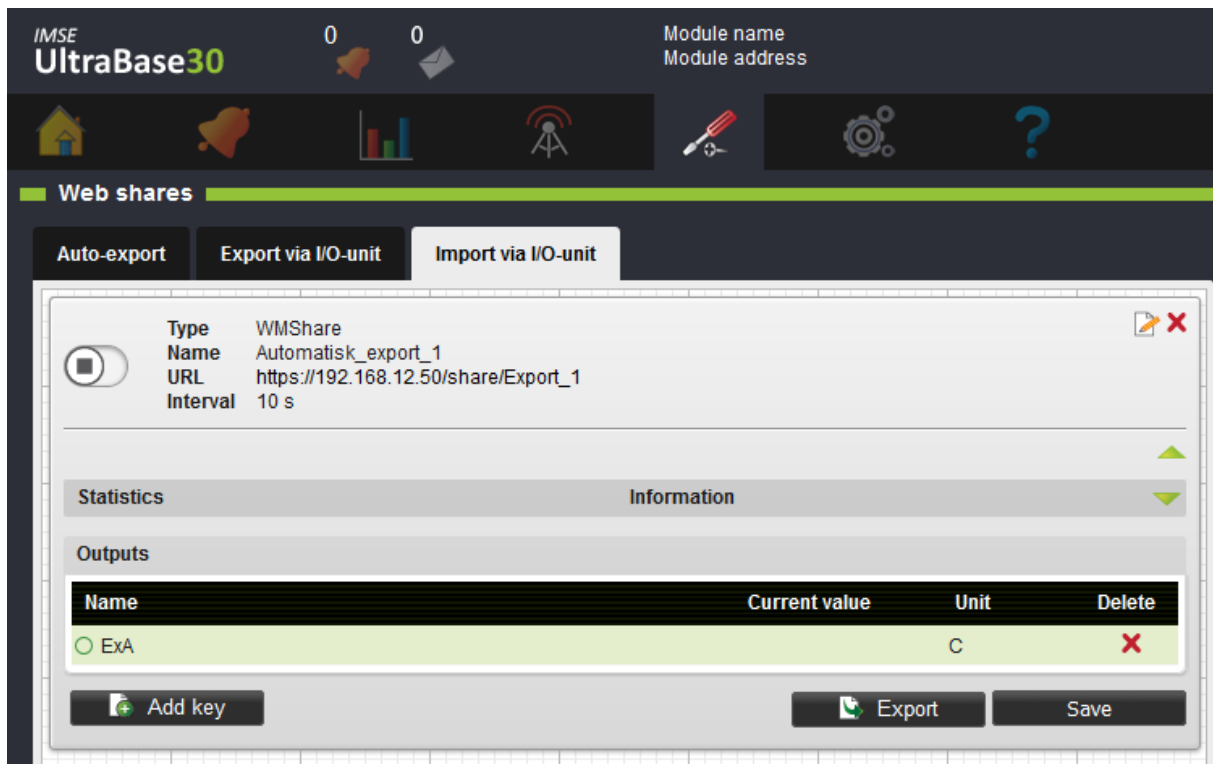

- Click on the status symbol in the upper left corner of the block to **activate** the share. The block turns green with a play symbol.

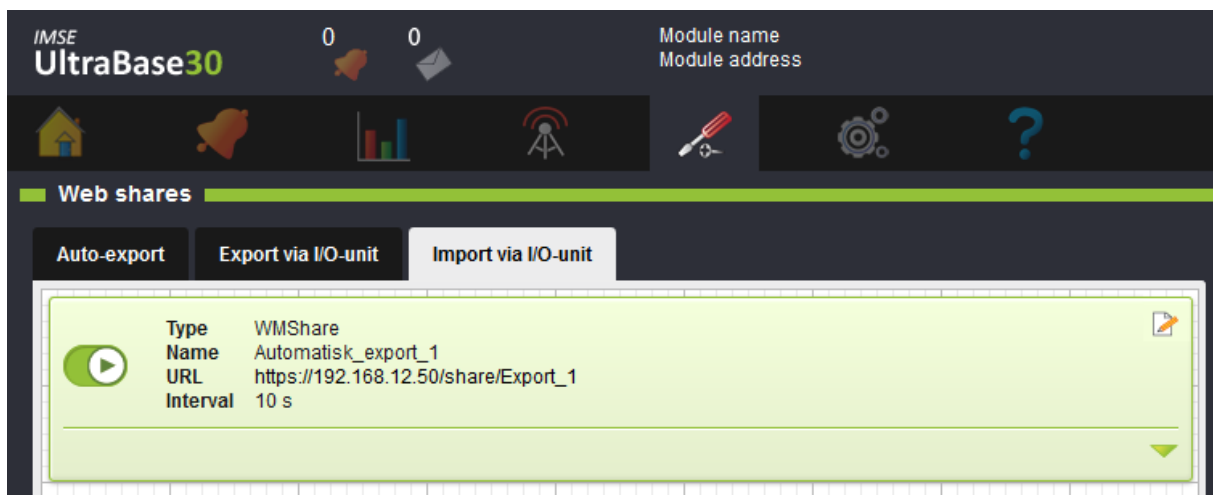

The share is now presented as an external unit in graphical programming where you can connect the

units inputs.

15.4 Error Status

If a blocks frame turns red it means that the communication does not work properly. Either the share cannot be retrieved from the specified URL, or there are some keys missing in the retrieved share.

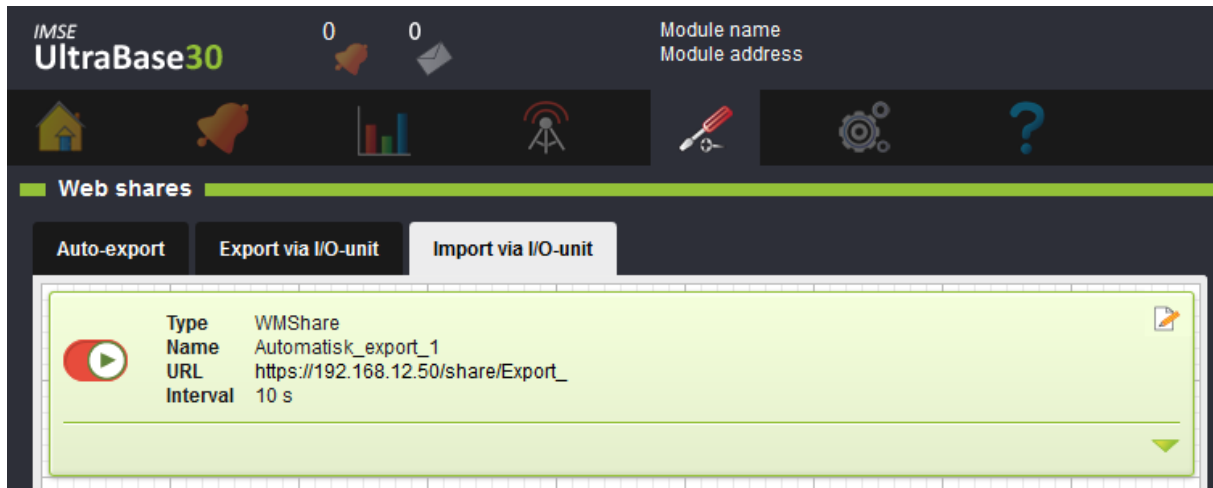

If any key is missing, the row turns red.

For an import, you can see under statistics the amount of retrieval attempts, amount of succeeded attempts and when the last successful import occurred. If a key is missing during an import, it will count as a format error.

16 Manual Override

Manual override means that you manually can force a channel to obtain a certain value. Manual override can be used on inputs, outputs, and internal channels. This is useful to test applications or a plant before putting it into service.

16.1 Allow Manual Override

In order to use manual override, you must first activate the function for the channel.

1. Go to a channels settings (in the **graphical programming** or under the menu **Configuration Applications & resources**).

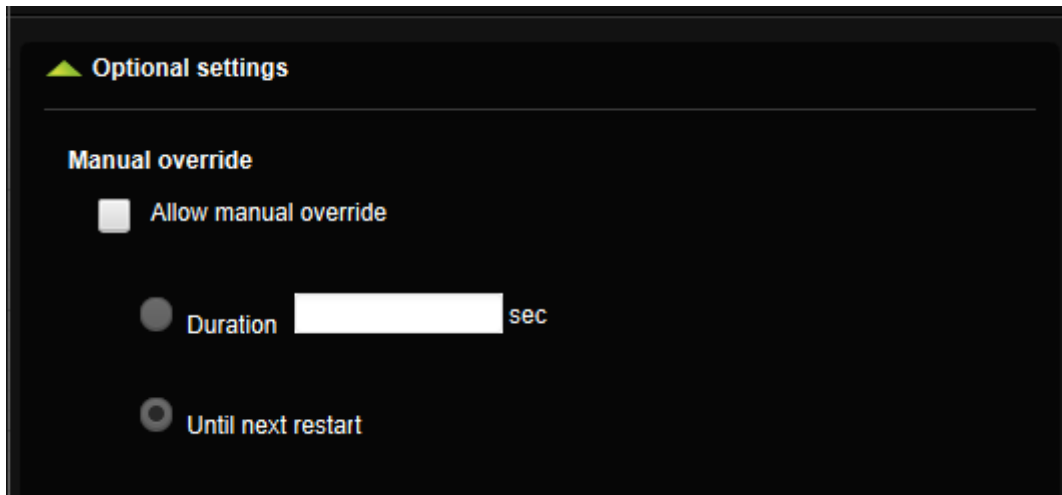

2. Check the box **Allow manual override** under **Optional settings**.
3. Enter **Duration** (for how many seconds the channel will have this value) you want the channel to have or choose **Until next restart**.
4. Click **Save**.

16.2 Activate Manual Override

I/O channels for inputs and outputs have as default the manual override allowed on outputs. For older devices, they are allowed on all I/O channels. You can manually override them in the **In- & outputs** menu under the **Configuration** menu.

1. Click on a unit in order to see more detailed information.

The screenshot shows the IMSE UltraBase30 control interface. At the top, the logo 'IMSE UltraBase30' is visible along with notification icons (0) and system information including 'Module name', 'Module address', the date '2020-10-05 10:04:51', and the 'Abelko INNOVATION' logo. Below the navigation bar, the 'In- & outputs' section is active. It features a central image of the UltraBase30 module. To the left of the module, a list of input channels (UI1 to UI16) is shown, each with a status of '199940.01' and a hand icon. To the right, a list of output channels (AO1 to AO6 and DO1 to DO4) is shown, with AO1-AO6 at '0.00 V' and DO1-DO4 at '0'. A sidebar on the right titled 'Insert' contains icons for 'Create new' and three module types: 'ExD8', 'ExDI12', and 'ExM28'.

2. Channels who allows manual override will have a hand symbol next to it. Click on the **hand** symbol.

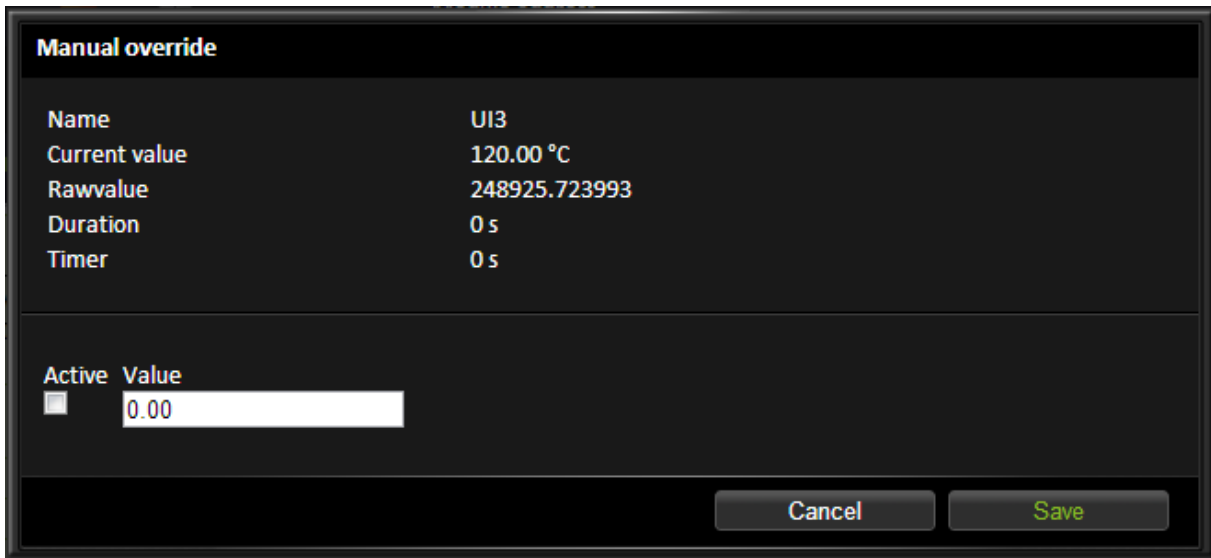

3. Here you can edit the manual value. Check the box **Active**.
4. The channel will get the manual value when you click **Save**. The duration counter will start the countdown and when it reaches zero, the channel value will return to its real value.

You can also enable manual override in the menu **Configuration** and **Applications & Resources**. There you will find both regular channels and I/O channels. The gray hand filters out all channels that allow manual control. The hand symbol at the far right of each line opens the manual control menu.

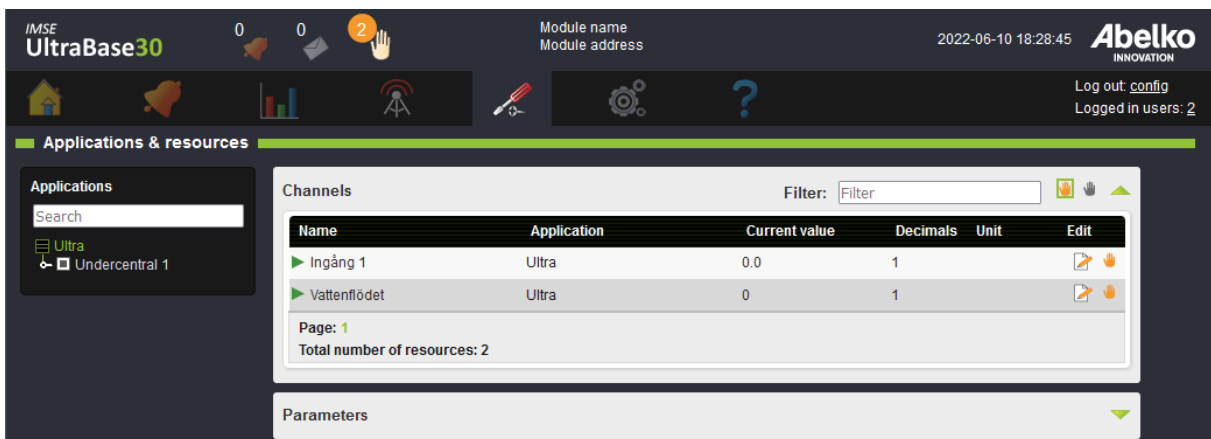

When any manual override is active, the hand symbol and a counter appears next to the messages icon. If you click on it, you will go to **Applications & Resources**, with the active manual overrides filter (an

orange hand) enabled.

17 System

This chapter will explain the note tool and the file manager. You will also learn how to create backups and update the system.

17.1 Notes

Notes are intended to be used to keep track of changes made in the system and inform other users in the system. A note is a short message that is added to a list. When a new note is created, it is indicated on the letter icon at the top of the interface. A number shows how many unread messages the logged in user has. Click on the letter icon or go to **System** and **Notes** to access the menu.

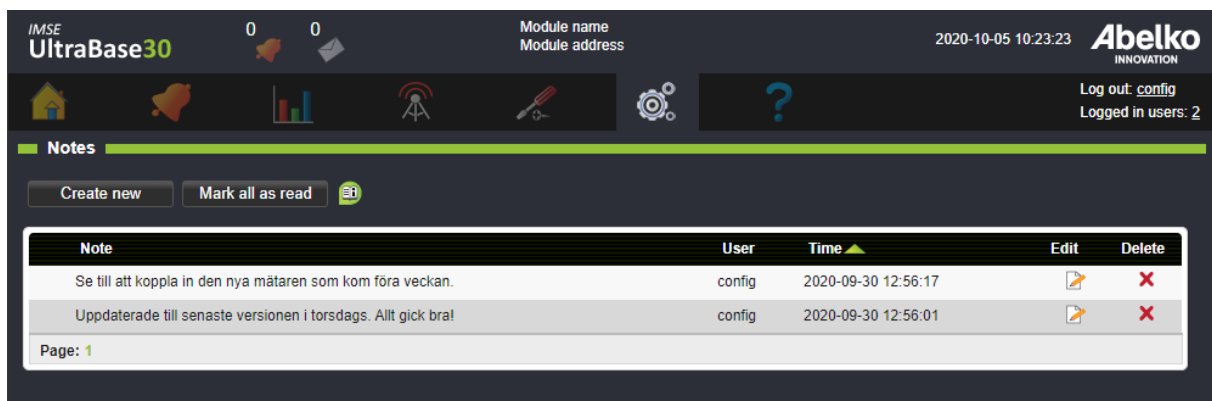

Note	User	Time	Edit	Delete
Se till att koppla in den nya mätaren som kom föra veckan.	config	2020-09-30 12:56:17		
Uppdaterade till senaste versionen i torsdags. Allt gick bra!	config	2020-09-30 12:56:01		

Page: 1

1. Click **Create new**.
2. Add a note and your name. You can mark the note as **High priority**. This means that it will be placed at the top of the list with an exclamation mark.
3. When you click **save**, all users will have a new note to read.

Click on a note in order to read the whole note.

By clicking **Mark all as read** the letter symbol for new messages will be turned off for the user who is logged on.

17.2 File Manager

Files are accessed through the **File manager**. You can copy a files to and from a PC, and delete files on the system.

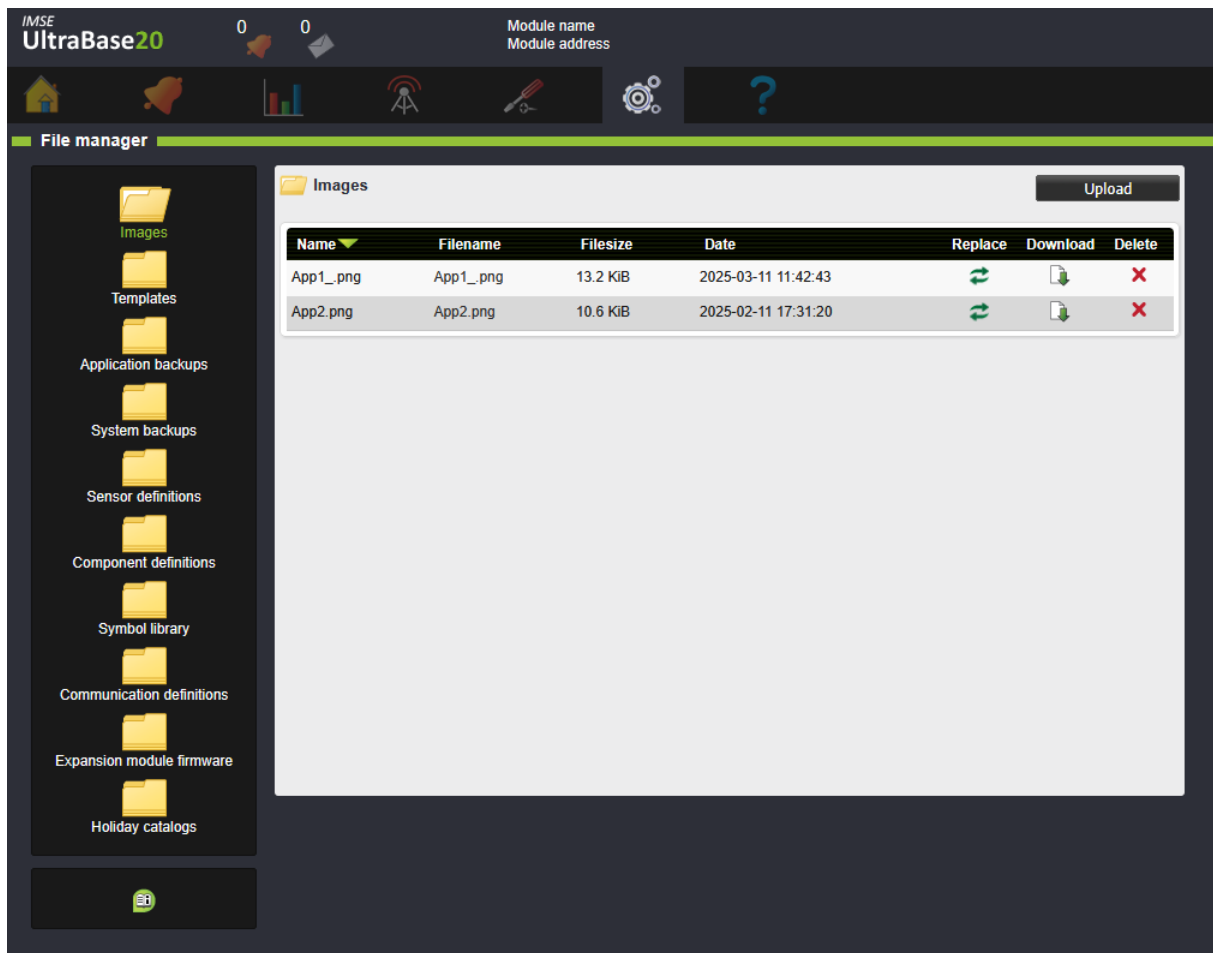

Files are stored in predefined folders according to their function.

Images Upload images for overviews and other pages. The recommended formats are **jpeg, png and gif**. It is also possible to upload pdf-files and other files that you want to create links to from the summary pages.

Templates Upload application templates that were created in an Ultra. All templates that are created in the device can be found here. You can download the files to your computer by clicking on the file name or download icon.

Backups Upload application backups containing parameter banks (no user settings, IP address or network settings) from an Ultra. When backups are created in the device they can be found here. You can download the files to your computer by clicking on the file name or download icon.

Sensor definitions Upload definitions for sensors and actuators.

Component definitions Upload components to use in the graphical programming.

Symbol library Upload symbols libraries to use when you create overviews. Libraries can be created with the Symbollib creator PC program.

Communication definitions Upload definitions for external units and expansion modules. Usable definitions are available at script.abelko.se.

Expansion module firmware Upload firmware files for expansion modules. Firmware files are available at abelko.se.

Holiday catalogs Upload holiday catalog files with format json to use when creating time schedules. When creating your own files, use following format:

```
1 {
2     "Items": [
3         {
4             "Name": "New Year's Day",
5             "Date": "2023-01-01",
6             "Weekday": 7
7         },
8         {
9             "Name": "Epiphany",
10            "Date": "2023-01-06",
11            "Weekday": 7
12        },
13        {
14            "Name": "Good Friday",
15            "Date": "2023-04-07",
16            "Weekday": 7
17        }
18    ]
19 }
```

Name: is the name of the day. **Date:** is the date of the day, YYYY-MM-DD. **Weekday:** is the weekday you want the date to be counted as, where 1 = Monday, 2 = Tuesday and so on.

SD Card (UltraBase30 only) Contents of the SD card.

System Backups (UltraBase20 and UltraBase40 only) System backups stored on the device.

USB memory (UltraBase30+ only) Contents of the connected USB memory.

17.3 Users

Create and edit users.

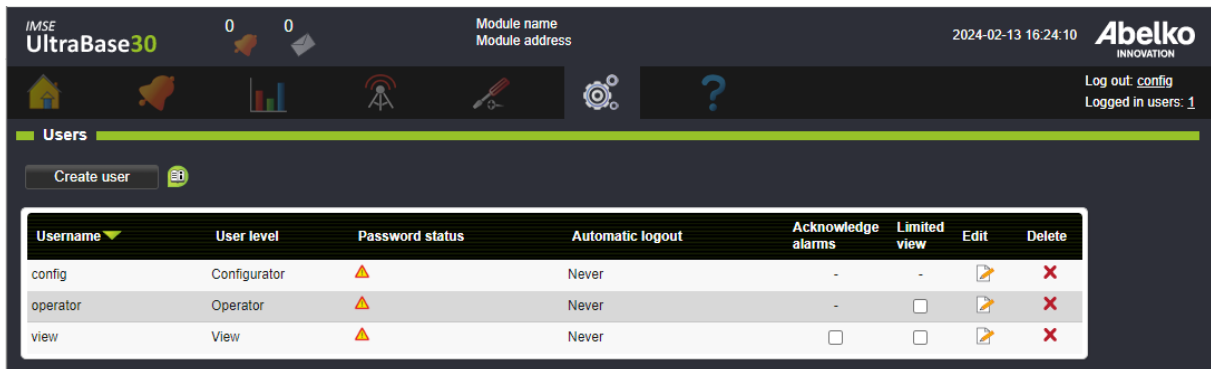

1. To create a new user, click **Create user**.

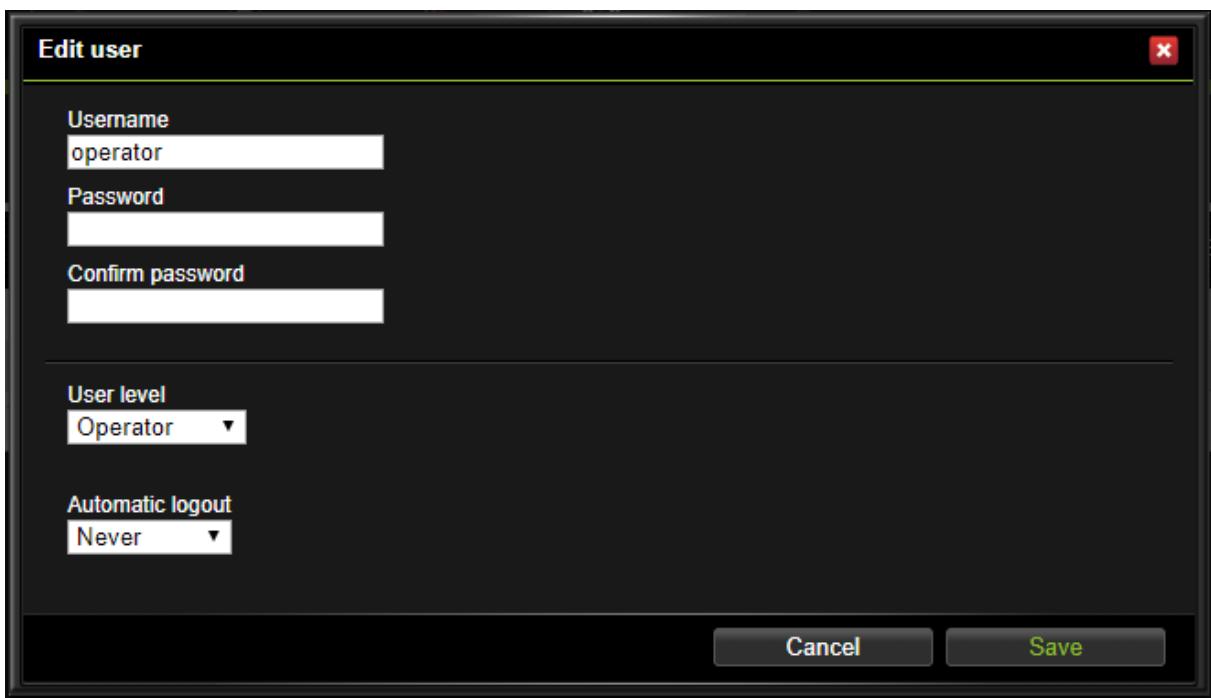

2. Set a **Username** and a **Password**. Select a **User level**.
3. Select if **Automatic logout** shall be active by choosing an appropriate timeout.
4. Click **Save**.

Requirements for user names and passwords

UltraBase30+

Username must be at least 4 characters and a maximum of 32 characters long. Passwords must be at least 8 characters and a maximum of 32 characters long.

The following characters are allowed for use in usernames and passwords:

```
!#$%&'()*+,-./0123456789:;<=>?@ABCDEFGHIJKLMNOPQRSTUVWXYZ []^_`abcdefghijklmnopqrstuvwxyz{|}~
```

UltraBase20, UltraBase30 and UltraBase40

User names and passwords must be at least 4 characters and maximum 32 characters. The following characters are allowed in user names and passwords:

```
!#$%&'()*+,-./0123456789:;<=>?@ABCDEFGHIJKLMNOPQRSTUVWXYZ []^_`abcdefghijklmnopqrstuvwxyz{|}~
```

User levels:

Configurator	Has access to all the settings of the system.
Operator	Adjusts set points, acknowledge alarms and more, but does not create new applications or upgrade the device.
View	Cannot change settings.

Password status indicates that the standard password has not been changed. If it has not been changed, a warning triangle is shown, otherwise, the text OK is shown.

Automatic logout shows the interval within which the user must be active before her or she is automatically logged out.

Acknowledge alarms means that user level View can acknowledge alarms. Operator and Configurator always have this permission.

Limited view means that the user can only see the following menus:

- Home: **Overviews** and **Summaries**
- Alarm: **Active alarms** and **Alarm history**
- Data: **Data logs**

System: **Notes** and **Information**

Help: **Manuals** and **Support**

To temporarily leave this mode, the user can go to the menu **Help** and **Support**. Under **Limited view**, the user can enable/disable the limited view temporarily by using the check box, and then click **Set**. Now the user will be able to see the menus until the pages are updated or until the user log out.

17.4 Settings

The screenshot shows the IMSE UltraBase30 Settings interface. At the top, there are navigation icons and a header with 'Module name' and 'Module address' labels. The main content is organized into three panels:

- Settings:** Contains two input fields for 'Module name' and 'Module address', and a 'Save' button.
- Choose start page:** Features radio buttons for 'Overview', 'Summary', and 'Active alarms' (selected). It includes dropdown menus for 'Name' (Overview, Summary) and a 'Custom tree view' section with a 'Show on startpage' checkbox and an 'Edit' button. An 'Expand companion trees' checkbox is also present.
- Set time:** Includes date and time pickers (Date: 2026-03-04, Time: 10:32:33), a 'Timezone' dropdown (Europe/Stockholm), and an 'Activate NTP' checkbox. Below this are four input fields for 'NTP server 1' through 'NTP server 4'.

17.4.1 Settings

Enter the name and the address of the module under the menus **System** and **Settings**.

17.4.2 Choose start page

Select the **start page** of the system. You can choose between overviews, summaries and active alarms. Besides that you can also choose to **customize the tree view** on the start page. You can choose which overviews and summaries that should appear, and in what order they should appear.

1. Click on **Edit**

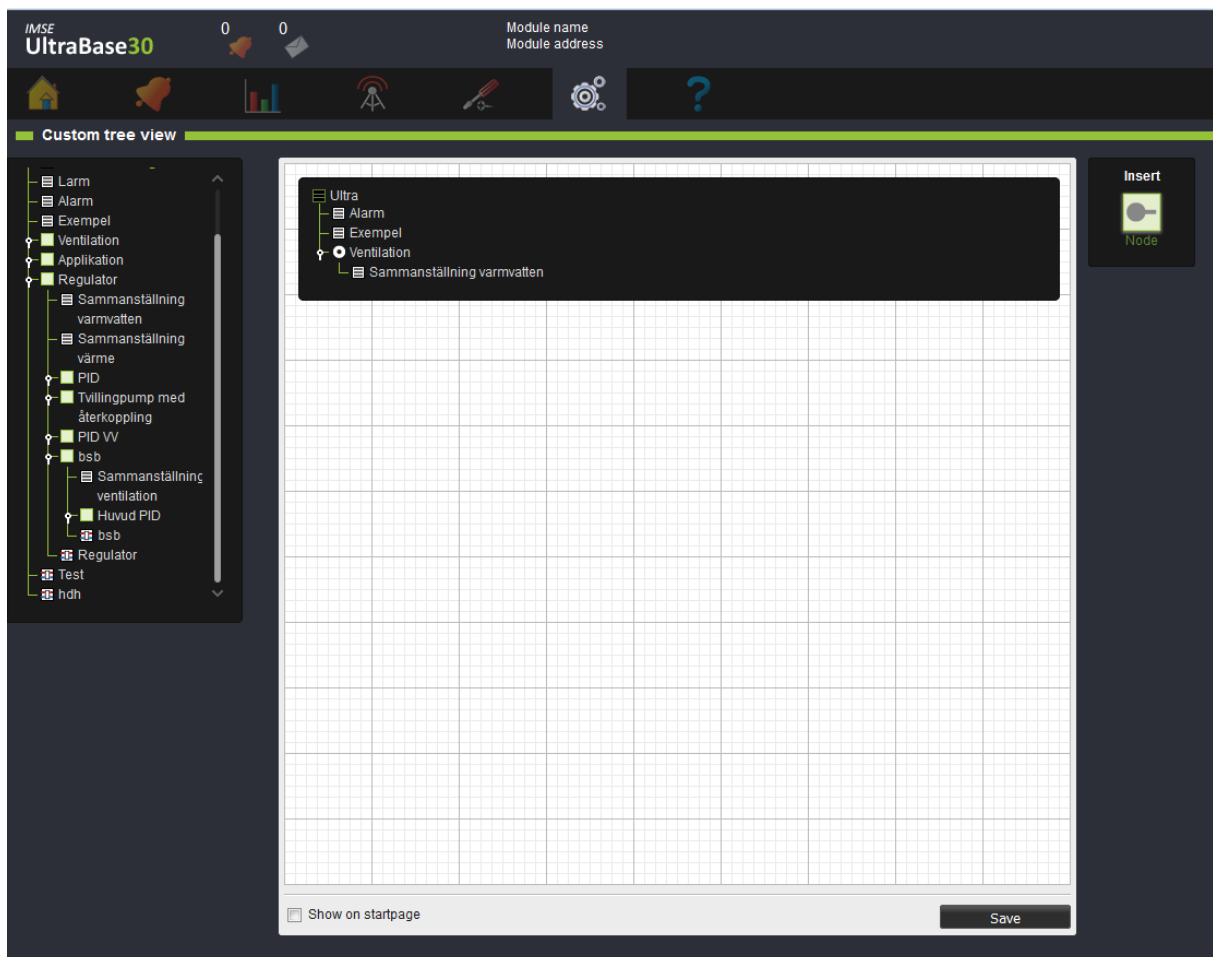

2. To add elements to the list, drag the ones you want from the impressions left. You can select where in the tree you want to place the element. Releasing a node next to a group which is

located at e.g. level two, will add the new node on the same level.

3. To add new nodes, you can drag one from the Insert menu to the right.
4. When you are finished, press **Save**.

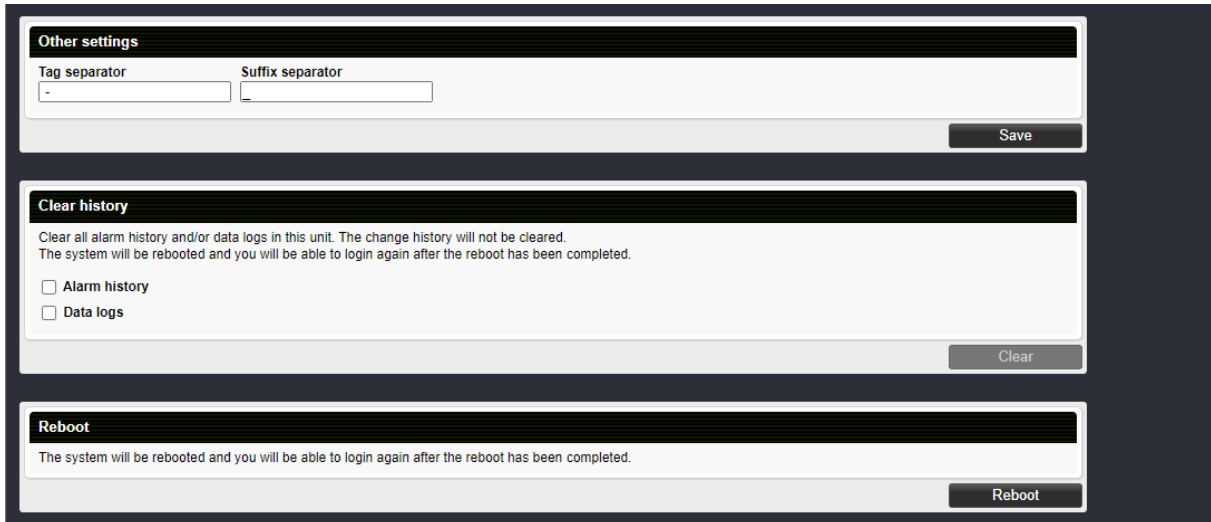

The screenshot displays three distinct settings panels on a dark background. The top panel, titled 'Other settings', contains two input fields: 'Tag separator' with a hyphen '-' and 'Suffix separator' with an underscore '_'. A 'Save' button is positioned at the bottom right of this panel. The middle panel, titled 'Clear history', includes a descriptive paragraph and two checkboxes: 'Alarm history' and 'Data logs', both of which are currently unchecked. A 'Clear' button is located at the bottom right. The bottom panel, titled 'Reboot', features a single line of text and a 'Reboot' button at the bottom right.

17.4.3 Set time

Set the system time of the UltraBase. It is recommended to use NTP when possible as this will automatically synchronize the time with the NTP server. Up to four NTP servers can be used. Example settings shown in the image above.

17.4.4 Time zone

Select the time zone for the UltraBase. When time zone is changed the system requires a reboot.

Timestamps in the web pages will be displayed in the selected time zone, for example data logs, alarm history and change history. Time schedules rules will be executed in the selected time zone. Information from companions, such as alarm history, will be displayed in the time zone of the main companion.

17.4.5 Other settings

Tag separator and **Suffix separator** are used for name formatting when exporting a Modbus slave register list. A name can be separated into a tag and a comment using a preselected **Tag separator**

(default is “ - “).

17.4.6 Clear history

Clears all alarm history in the unit and/or the data that is in the units data logs. Change history will not be cleared, but **Clear history** will appear in the change history. The system will be rebooted and you will be able to login again after the reboot has been completed.

1. Select which data you want to clear and click **Clear**.
2. Confirm the cleanup by entering **User name** and **Password**. Only users with config level are authorized to perform the cleanup. Click **Clear**.

17.4.7 Reboot

Reboots the system.

17.5 Backups

Here you can upload, create, export and restore **application backups** and **system backups**.

The screenshot shows the IMSE UltraBase30 web interface. The top navigation bar includes the logo, status indicators (0), module information, the date and time (2017-12-08 08:21:08), and the Abelko logo. Below the navigation bar, there are several icons representing different system functions. The main content area is titled "Backups" and is divided into two sections: "Application backups" and "System backups".

Application backups

Name	Description	Date	Delete	Export	Restore
2016-12-19		2016-12-19 10:15:23	X		
FactoryDefaults		2015-11-12 10:10:23	X		

Page: 1

System backups

Automatic backup to SD-card

Periodically: Time: Day: Automatic backups are disabled

Name	Date	Delete	Export	Restore
ultraBaseBackup_00000186_20150409_090054.tar.gz	2015-04-09 09:45:24	X		
ultraBaseBackup_00000186_20150415_130010.tar.gz	2015-04-15 13:15:26	X		
ultraBaseBackup_00000186_20150415_131557.tar.gz	2015-04-15 13:23:54	X		

Application backups: an application backup contains all files and settings that determine what the device does. This means all applications in graphical programming, application settings, summaries and overviews, configuration of inputs and outputs, and more.

An application backup does **not** include network settings, logged data, alarm history, and notes. You can use an application backup to reset settings before changes were made or to create a new device with the same function.

System backups: a system backup is a complete backup of all data and settings in the device. It also includes network settings, logged data, alarm logs and notes. The system backup is intended to be used to restore a replaced or broken device. It requires considerably more space than an application backup and must on a UltraBase30 be saved on an SD card. In UltraBase20 and UltraBase40 it is stored in internal flash.

When you restore a system backup, the network settings are overwritten. If the backup contains settings that do not match the location of the device, you may lose contact with the device. User settings will be overwritten so user names and passwords may be changed. Logged data, alarm history and notes will also be overwritten. This means that, all information that was generated after the backup was created, will be lost.

A system backup does **not** include the network setting **Allow unencrypted connection**.

NOTE! When using an SD card, it is important that it is formatted with the FAT32 file system. It is recommended to use an SD card that is 16Gb.

17.5.1 Create a new application backup

1. Click **Create new**.
2. Name the backup and add a short description.
3. Click **Create new**.

The backup is saved in the system and is added in the list of existing backups that you can delete, export and restore.

All backups are also available under the menu **System** and **File manager** in the **Backups** folder. There you can download an application backup to your computer or upload a previously saved backup to make a copy of an application.

17.5.2 Create new system backup (UltraBase30+)

In UltraBase30+ system backups are stored on USB-memory.

UltraBase30+ supports encrypted system backups. This is to protect sensitive information that may be included in the system backups. As a user, you can choose whether system backups should be encrypted or not; by default, they are not encrypted.

The following settings control the encryption of system backups:

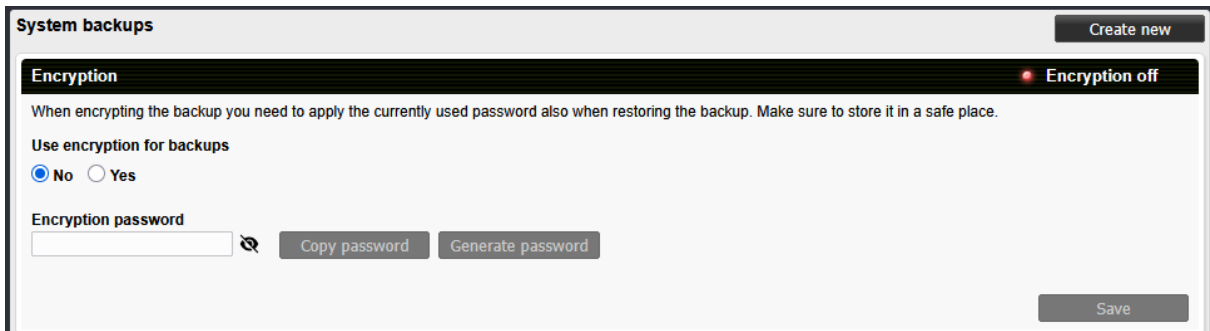

Use encryption for backups controls whether created backups are encrypted or not. The setting applies to both system backups created manually (the **Create New** button) and automatic backups.

Encryption password must be specified in order to create an encrypted backup. When **Use encryption for backups** is set to Yes, a password is generated that can be used. It is also possible to change it to a custom password or generate a new one. To restore the backup, the same password must be entered.

NOTE When encrypted system backups are used, it is very important to save the password in a secure location. Use the **Copy password** button to copy the password and then store it safely. A lost password cannot be recovered, and the backup will then be unusable.

After choosing whether or not to use encryption, system backups are created manually or automatically according to the following two sections.

17.5.3 Create new system backup (UltraBase20, UltraBase30 och UltraBase40)

To be able to create a system backup on an UltraBase30, you need to have an SD card inserted in the SD card slot on the front. On the UltraBase20 and UltraBase40, system backups are stored in internal memory.

1. Click **Create New**. Here you can see how much free space is available for backups. Keep in mind that it may take a while to create a system backup. In a hard working device it may take more than an hour.

2. Click **Create New**.

The backup is saved and is added in the list of existing backups that you can delete, export and restore.

17.5.4 Create an automatic system backup

An UltraBase can automatically create backups at regular intervals.

1. Specify how often the backup should be created. Keep in mind that it may take a while to create a system backup. In a hard working device it may take more than an hour.
2. Click **Save**.

17.5.5 Backup to SD-card using buttons on UltraBase30

At the front of an UltraBase30 beside the SD-card slot there are two buttons.

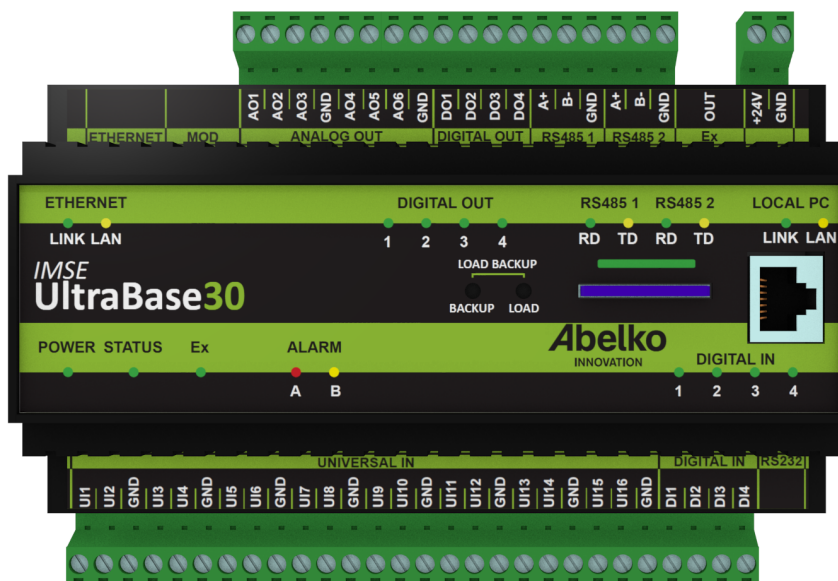

Note! If someone else is working on the device through the interface, the light above the SD card will flash green. Do not touch the SD card or the backup buttons during this process since it may interrupt their work.

Create a system backup with the buttons on the front

1. To create a system backup of the systems data to the SD card, hold the **BACKUP** button until the light above the SD-card starts to flash green.
2. The light above the SD-card will flash green during the whole process.
3. When the process is complete, the light will shine green. Now the backup is finished. The light will be active until the SD-card is removed or the device is restarted.

If an error occurs, the light will flash red for 15 minutes. A file will be transferred to the SD card with information concerning the error (as long as the card is not write-protected).

Note! SD-cards are not recommended for long term data storage. It is safer to transfer the backup file to a computer or similar.

Load a system backup with the buttons on the front

You can load a system backup into the system. The backup is usable when you, for example, want to replace an unit and need an exact copy.

1. To load a system backup, hold the buttons **LOAD + BACKUP** until the light above the SD-card starts to flash green.
2. When the process is completed, the light will shine green for **5 seconds**.

If an error occurs, the light will flash red for 15 minutes. A file will be transferred to the SD card with information about the error (as long as the card is not write-protected).

Execution of a load-file from SD-card (for example an update)

The file must be of type .load and may contain a software upgrades, parameter bank scripts and more. A .load file is created by Abelko on request.

1. To run a .load file, hold the **LOAD** button until the LED flashes green.
2. Depending on execution, the unit can be restarted. The LEDs will then go out for a few minutes.
3. When the process is complete, the light will shine green for 5 seconds. Now it's finished.

If an error occurs, the light will flash red for **15 minutes**. A file will be transferred to the SD card with information about the error (as long as the card is not write-protected).

17.6 Update

To update the software in the device, go to the **Update** menu under the **System** menu.

Note! Do not update to a package with a lower version number, it may cause incompatibility issues.

1. Download an upgrade package from Abelko's support page and save the file somewhere where you can find it.
2. Click **Bläddra/Browse** under **Firmware File** and select the upgrade package.

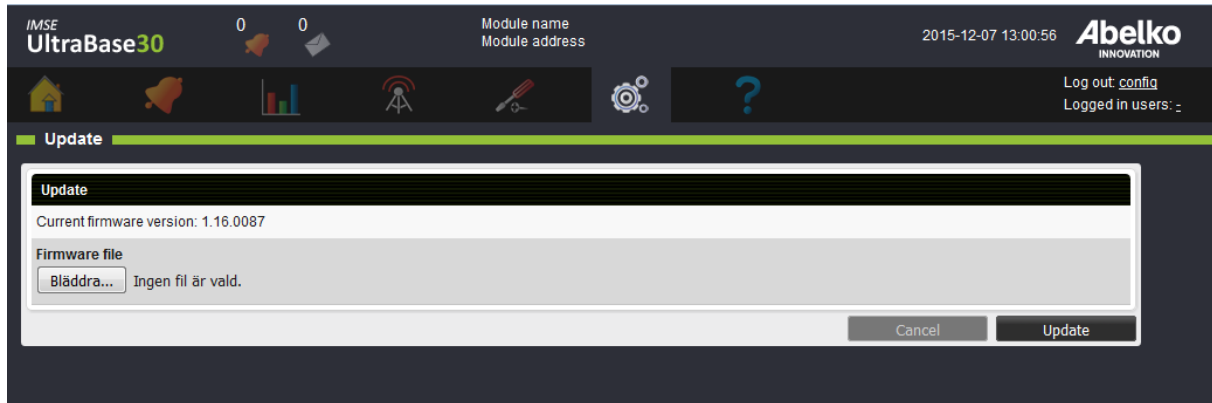

3. Click **Update**.
4. You will soon see a new window with update information.
5. When the system has updated everything, you will be able to log in again.

17.6.1 Expansion modules

Here you can update the firmware of connected expansion modules. To update a device a matching firmware file must first be uploaded. It can be done by selecting a file and clicking the **Upload** button, but also from the **File manager** under **Expansion module firmware**. Firmware files for supported devices can be downloaded from abelko.se.

The following expansion modules support firmware update:

- ExM5
- MxM5

All connected expansion modules that support firmware update will be displayed in a list below. For each device the following is displayed:

- **Device type**
- **Serial number**
- **Installed version** The currently installed version of bootloader and firmware in the device. (Not displayed for devices without a communication definition)

- **Uploaded package** The version of bootloader and firmware available in the uploaded, matching package.
- **Cable sequence number** (Only shown for Ex modules)

The following conditions must be met for the **Update** button to be active:

- There is an uploaded Firmware package that matches the expansion module type.
- The bootloader or firmware version in the uploaded package differs från the installed version

While update of a device is in progress all other expansion modules will temporarily be disconnected.

Note: Do **not** disconnect the power of the device while the update is in progress.

Note: If transfer fails when updating an Mx-module, set the **Communication timeout** for the external unit to the value **5** on the page **External units** and try again.

The screenshot shows the IMSE UltraBase20 software interface. The top header includes the Abelko logo, the date and time (2025-02-11 18:20:08), and user information (Logged in users: 1). The main content area is titled "Update" and contains three sections:

- UltraBase Firmware:** Shows the current SW Release version (1.99) and a firmware file upload area. A warning message states: "Do not update to a package with a lower version number, it may cause incompatibility issues." Buttons for "Cancel" and "Update" are visible.
- Expansion modules:** Shows a firmware file upload area. A message states: "The uploaded package will be applied to matching modules in the list, and enable the modules update button. Only one module at a time can be updated." An "Upload" button is present.
- Ex modules:** Displays a table of expansion modules. The table has columns for "Filename", "Installed version", and "Uploaded package". An "Update" button is located below the table.

Filename	Installed version	Uploaded package
Bootloader version	1.00	1.01
Firmware version	1.00	1.06

17.7 Information

Under the menu **System, Information**, you can view information about the system and its operation.

17.8 Change history

Under **System** and **Change history**, you can see history of which changes have been made in the system and by which user for selected resources.

The change history shows the last 200 changes back in time from the selected time. By selecting a time for the search, all change history stored in the unit can be accessed.

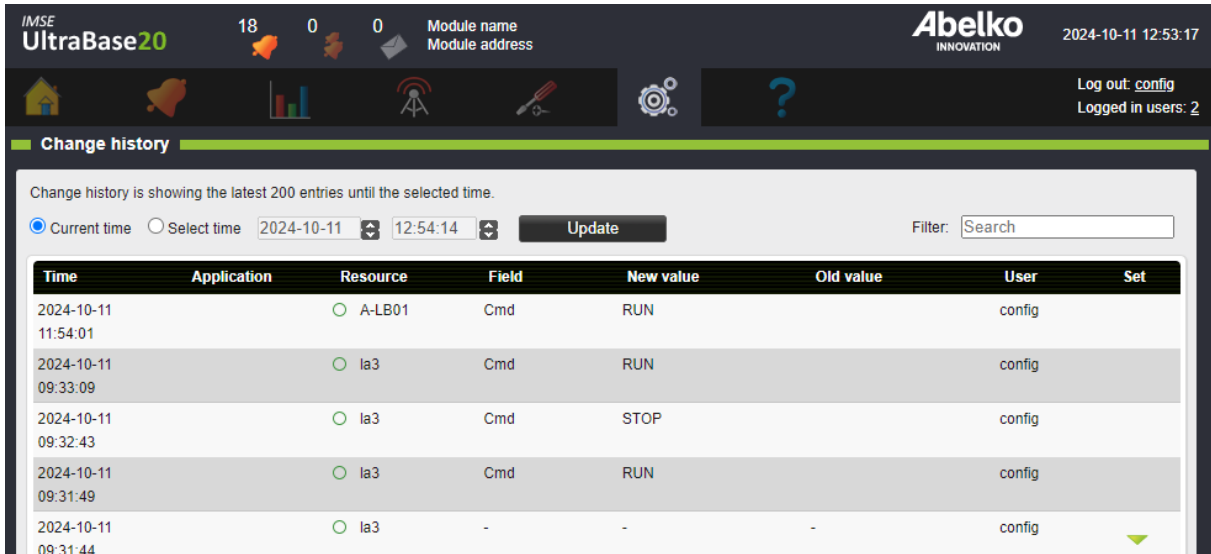

Change history is showing the latest 200 entries until the selected time.

Current time Select time 2024-10-11 12:54:14 Filter:

Time	Application	Resource	Field	New value	Old value	User	Set
2024-10-11 11:54:01		A-LB01	Cmd	RUN		config	
2024-10-11 09:33:09		la3	Cmd	RUN		config	
2024-10-11 09:32:43		la3	Cmd	STOP		config	
2024-10-11 09:31:49		la3	Cmd	RUN		config	
2024-10-11 09:31:44		la3	-	-	-	config	▼

In order to change back to a previous value, click on the green back arrow to the right. For some changes, several values have been changed in the same change and then a drop-down arrow appears. Check which values you want to change and click on the green back arrow.

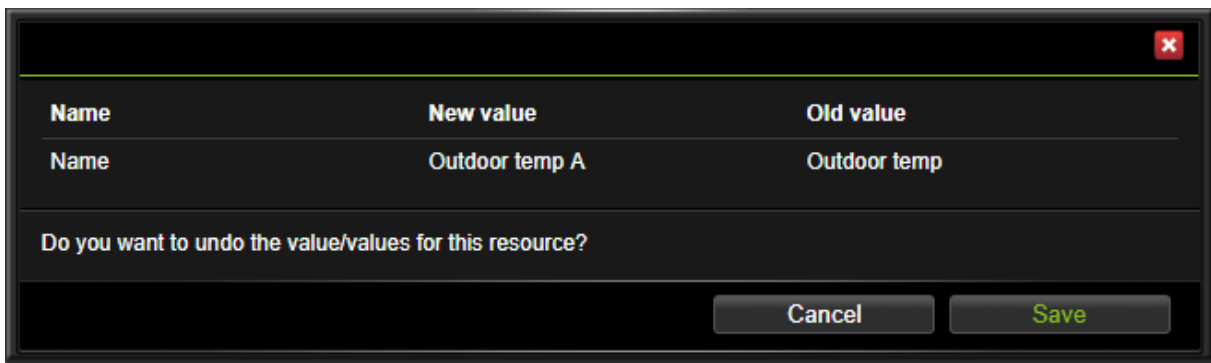

Name	New value	Old value
Name	Outdoor temp A	Outdoor temp

Do you want to undo the value/values for this resource?

18 Help

18.1 Support

18.1.1 Contact information

Enter contact information so that users can contact support personnel if needed. The contact information is shown on the login page. It is also possible to upload a custom logo that is displayed on the login page and in the page header when logged in. The logo will be scaled down to a max size of 200x45 pixels. Company and phone number is also displayed on the login screen of the IMSE Ultra OP.

The following fields need to be filled in for the contact information to be displayed on the login page:

- Company
- Phone number or Email

These fields also need to be filled in to be able to upload a custom logotype.

19 Communication

The **Communication** menu allows access to the systems network configuration, overview of alarm- and log sendouts, settings for outgoing mail and modbus settings.

19.1 Network

Network allows you to handle network settings for **Ethernet** and see information about **Local PC**.

The screenshot displays the network configuration page for the IMSE UltraBase30. The top navigation bar includes the product name, notification counts (2), and module information (Module name: Module address 2). The main content area is divided into two sections: 'Ethernet settings' and 'Local PC information'.

Ethernet settings

- Using DHCP
- IP address: 10.2.3.20
- Netmask: 255.255.254.0
- Gateway: 10.2.2.1
- DNS server 1: 10.1.0.18
- DNS server 2: (empty)
- DNS server 3: (empty)
- MAC address: 00:30:5e:0b:01:4e
- Allow unencrypted connection: Yes (dropdown menu)

Unencrypted connection over HTTP (port 80) is allowed. Communication including user credentials are sent in plain text when HTTP (port 80) is used. Connect to Ultra with https:// or http://

Local PC information

IP address	192.168.142.1
Netmask	255.255.255.0
MAC address	16:20:e5:83:85:25

Allow unencrypted connection controls whether or not it is possible to connect to the Ultra with unencrypted communication (with HTTP on port 80). If the connection is done with HTTP all communication, including login credentials, will be sent unencrypted over the network. Unencrypted communication is generally not recommended. To connect to the Ultra with encrypted communication the URL shall start with https://, and to connect with unencrypted connection it starts with https://. This setting is **not** included in system backups. This setting is not available for UltraBase30+.

If you change the IP address and click **Save**, you will be logged out from the system. Enter your new IP address up in the address bar in order to log in again.

Note: IP-addresses on the 192.168.142.XXX network are reserved for the **Local PC** port, and not possible to set for the **Ethernet** port.

You can always connect with a PC with a cable directly to the **Local PC** port to change network settings if you cannot access the device on the **Ethernet** port. The **Local PC** port has the fixed address **https://192.168.142.1** and uses DHCP to automatically assign your PC a IP address on the Local PC network.

Note: If the Ultra is on a network behind a router or firewall it needs to be ported out before it can be accessed from the outside. Contact the person responsible for your network environment to configure this in the network.

19.2 Mail Host

Here you can edit the settings for the unit's mail host for outgoing email. This setting is required in order to send emails for both alarm and log sendouts.

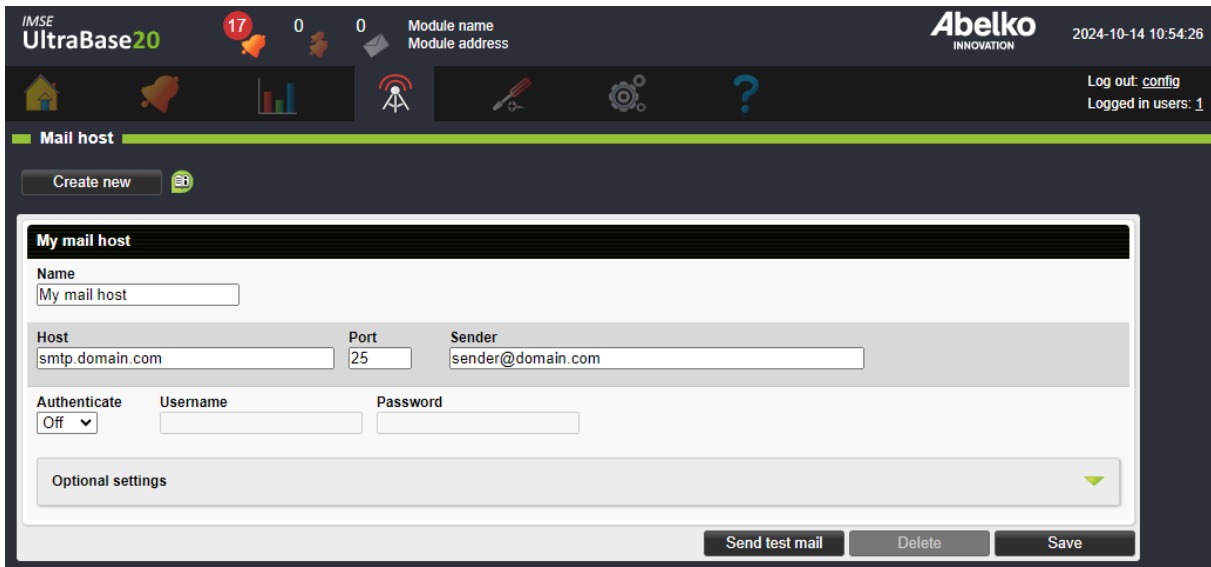

The screenshot shows the web interface for the Abelko UltraBase20. The top navigation bar includes the logo 'IMSE UltraBase20', notification icons (17, 0, 0), and the text 'Module name' and 'Module address'. The right side of the header shows the 'Abelko INNOVATION' logo, the date '2024-10-14 10:54:26', and 'Log out: config' and 'Logged in users: 1'. The main content area is titled 'Mail host' and features a 'Create new' button. Below this is a form titled 'My mail host' with the following fields: 'Name' (My mail host), 'Host' (smtp.domain.com), 'Port' (25), 'Sender' (sender@domain.com), 'Authenticate' (Off), 'Username', and 'Password'. There is also an 'Optional settings' section with a dropdown arrow. At the bottom of the form are three buttons: 'Send test mail', 'Delete', and 'Save'.

1. Enter **Host**, **Port** and a valid **Sender** for the mail host.
2. **Name** is used to distinguish the different servers in the system.
3. Many email servers require **authentication**. Select **Auto** and enter **Username** and **Password** for the email server (this is something you receive from your Internet service provider).
4. Click **Save**.

All email recipients are tied to a mail host defined in the settings. You can define more than one mail host.

19.3 Recipients

View and edit all the people registered in the system. You can also add new recipients. This section gives you an overview over which alarm and log sendouts the different recipients will receive.

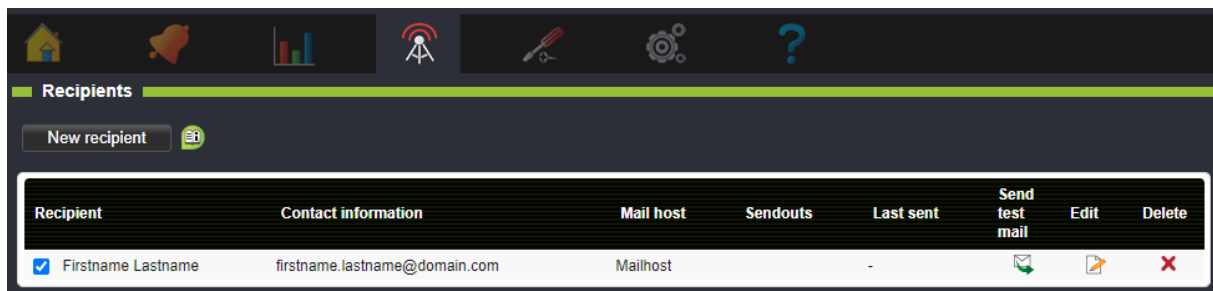

You can inactivate a recipient with the box next to the recipient's name. You can also send a test mail.

19.4 Modbus Slave Register

Modbus is a protocol used to communicate between devices. Here you create and edit register lists for Modbus-slave-communication. The register list determines what is available via Modbus, and how the information is encoded. More information about Modbus is available on modbus.org.

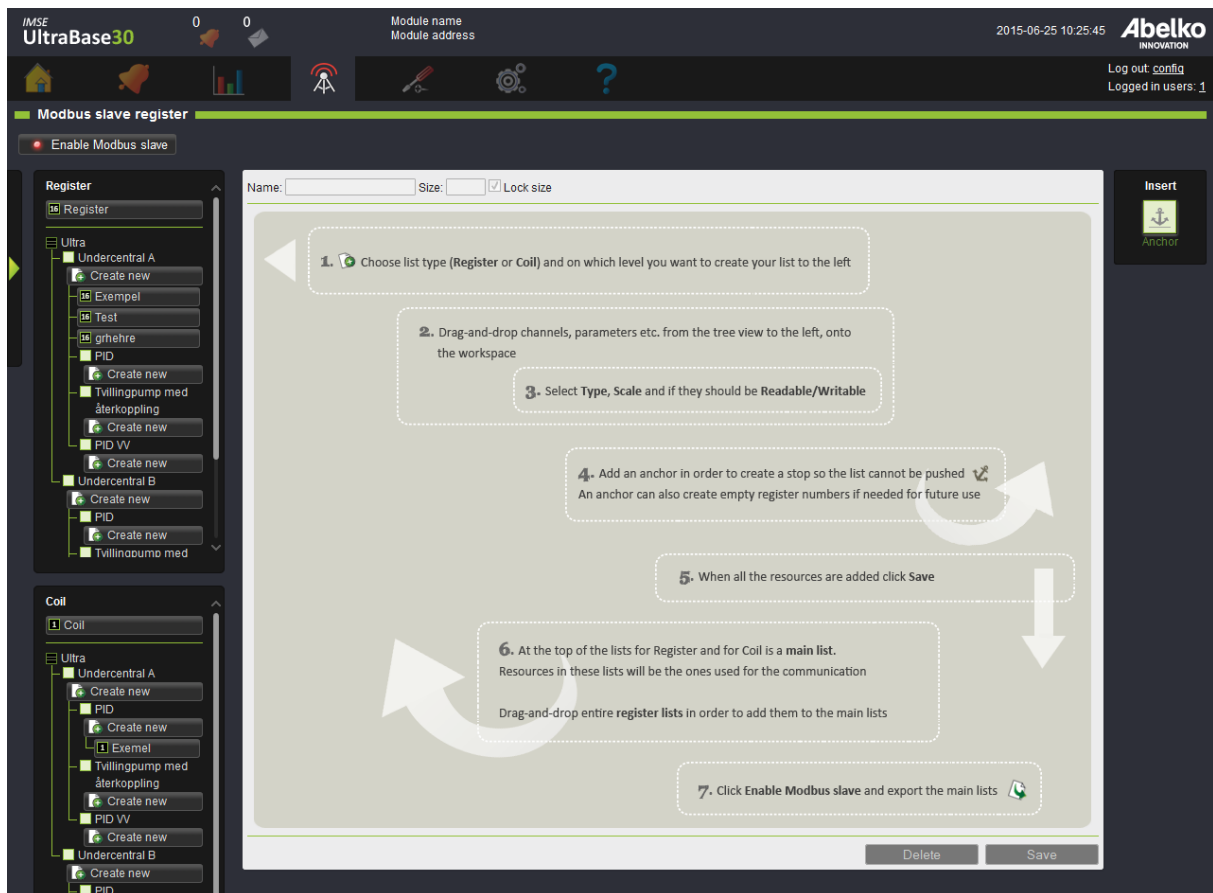

Create register lists

There is a global list for register and one for coil (located at the top of their node tree). All values that should be accessible in Modbus must be in one of these lists. You can also create registry mappings in applications. These can then be placed in the global list. It is a way to reuse register mappings that comes with applications.

1. Decide which type of list you want to create. To the left you can find one node tree for **Register** and one for **Coil**. A register is a 16-bits word and a coil is a 1 bit word.
2. Click **Create new** under the application you are interested in creating a mapping for or select the global main list at the top.
3. Drag-and-drop the resources you want in the list from the tree view, recessed to the left. You can switch between resources node tree and node tree over mappings using the green arrow. You can only choose resources from the application you created the list in, and also its subapplications. You can also link another register list in your list by dragging and dropping it from the node tree.

To reduce the number of clicks, you can drag-and-drop an application onto the workspace. By

using the search box, you can also filter which resources should be included. **Regular Expression** is a programming language that uses special syntax rules. For example [abc] shows all resources containing a, b or c. Another example is four|4 which shows all resources containing either four or 4.

Select the **Resource type** you want to add and if you want any resources in sub-applications to be included. You can only select one resource type at a time (channel, parameter, alarm, alarm group or curve). Select which metrics of the resource type to add to the list and settings for these. You can see how many resources that are included and how many registry entries that will be created.

Application: Applikation1 ✕

Chosen resource type

- Channel ▲
- Parameter
- Alarm
- Alarm group
- Curve ▼

Include resources from subapplications

Number of resources in search : **15**

Number of registers to create : **15**

Resource Type	Type	Scale	Read/Write
<input checked="" type="checkbox"/> Channel.Value	Int 16 ▼	1	Read/Write ▼
<input type="checkbox"/> Channel.Manual Override Value	Int 16 ▼	1	Read/Write ▼
<input type="checkbox"/> Channel.Manual Override Active	Int 16 ▼	1	Read/Write ▼

4. The resource will receive a **Register number**. Move the resources in the list in order to change its register number.

IMSE UltraBase30 0 0 Module name Module address 2015-02-27 08:58:43 Abello INNOVATION Log out: [confia](#) Logged in users: 3

Modbus slave register

Enable Modbus slave

Name: Exempel Size: 16 Lock size

Register Number	Resource Type	Name	Application	Type	Scale	Read/Write	
00001	Channel	WV Reglerfel	Undercentral A	Int	1	Read/Write	X
00002	Channel	WVC Tilloppstemp	Undercentral A	Int	1	Read/Write	X
00003	Channel	Ställdon 1	Undercentral A	Int	1	Read/Write	X
00004	Channel	Reglerfel	Undercentral A	Int	1	Read/Write	X
00005	Parameter	WV BV max	Undercentral A	Int	1	Read/Write	X
00006	Curve.Y values	VS Värmekurva	Undercentral A	Int	1	Read/Write	X
00012							

Delete Save

Insert Anchor

5. Select **Type** (16-bits, 32-bits, 64-bits and so on). Since every row is 16 bits, a 32 bit will reach over two rows. The value is multiplied by a scaling factor before it is added to the register. For integer registers you can use this to get decimals. The Modbus master then needs to divide with the same scale factor on its side. For example, with the **Scale** 10 for a temperature, the master will read the value 257 if the temperature is 25.7 degrees. A coil are always 1 bit so they don't have these settings. Also, select if you want it to be **readable**, **readable/writable** or **none**.

6. Click **Save**.

Note! The lists located at the top for each type is the lists with the final addresses, main registers. This means that these are the only lists that can be exported and used.

7. If you created Modbus mappings under applications, you need to add them to the main register. To do this, click on the main register for each type and then drag-and-drop mappings from the resource node tree to the main register. **Click Save**.

8. Click **Enable modbus slave** in order to lock the lists and start the communication.

9. Click  in order to export the list. You can export two lists, one for Register and one for Coils.

To the right there is an **Insert** menu.

Anchor works as a stop so the list cannot be pushed over a set register number. It can be useful to add an anchor in order to save space for future resources so you don't have to change the order of the register numbers.

The screenshot shows the 'Modbus-slav register' configuration window in the IMSE UltraBase30 software. The window title is 'Modbus-slav register' and it has a sub-header 'Aktivera Modbus-slav'. The main area contains a table with the following data:

Registernummer	Resurstyp	Namn	Applikation	Typ	Skala	Läs/Skriva	
00001	Kanal	VV Reglerfel	Undercentral A	Int	1	Läs/Skriva	✗
00002	Kanal	Ställidon 1	Undercentral A	Int	1	Läs/Skriva	✗
00003	Kanal	P1 Driftind	Undercentral A	Int	1	Läs/Skriva	✗
↓ 00010							✗
00010	Kurva.X-värden	VS Värmekurva	Undercentral A	Int	1	Läs/Skriva	✗
00016							

Buttons 'Radera' and 'Spara' are located at the bottom right of the table. The left sidebar shows a tree view with various system components like 'P1 Driftind', 'P2 Driftind', 'PID', 'Tvillingpump med återkoppling', etc.

Change an active register list

When you have a register list in use, changes like adding a new row will have consequences for the communication.

1. Inactivate the communication by clicking the button **Disable Modbus slave for editing**.
2. Edit the resources.
3. If you want to add new resources in the list, you can use the empty rows you added with help of the anchor tool.
4. If you add a new row so the register numbers shift, the row will turn red. If you want it to be available for export you need to change the list seize next to the list name. This will create a shift in the list and the register numbers will be updated. Changes like this needs to be adjusted in the supervising system as well.
5. When you have edit the list, click **Save** and then **Enable Modbus slave** in order to continue the communication again.
6. You have made changes that cannot be save. Please resolve the issues and then try and save again.

Note! If the message “You have made changes that cannot be saved. Please resolve the issues and then try and save again.” is displayed when saving, make sure that there is at most one anchor with the same register number, and that all registers are in numeric order in the list.

19.4.1 Register types

Int and Word

In Modbus, a register is a 16 bits word that can have a value between 0 and 65535. In the interface, this register type is called **Word**. If you want to transfer values with decimals over Modbus, you can use a scale factor. In order to transfer a temperature value with two decimals, set the scale factor to 100. The value, for example 12,34°C, will then be read from the register as 1234. The master who reads it must know how much the value is being scaled.

If the value can be negative it needs to have the register type **Int**. The first bit in the 16 bits word will then be treated as a sign bit. Numbers from -32768 to 32767 can be represented.

If the value is outside of this register types range the master will read it as an incorrect value.

Int32 and Word32

If you want to be able to represent larger values, or values with higher dissolution, you can use two Modbus registers in order to represent a 32 bits word. Set **Int32** or **Word32** as register type. **Int32** can represent numbers from -2147483648 to 2147483647. **Word32** can represent numbers from 0 to 4294967295.

Float

Float is a 32 bit floating-point number following the IEEE 754 standard. Float can handle numbers with about 6 significant digits, (almost) regardless of how large or small values it is.

One problem with floating-point numbers on Modbus is that it does not have a standardized order in which the four bytes that make up the floating-point number should be sent. The Ultra supports all of these four possible ways.

Below you can see how Pi is represented as a float, and how the four bytes titled A to D.

s	exponent							Mantissa																							
0	1	0	0	0	0	0	0	0	1	0	0	1	0	0	1	0	0	0	0	1	1	1	1	1	1	0	1	1	0	1	1
4				0				4				9				0				F				D				B			
Byte D								Byte C								Byte B								Byte A							

The letters after **Float** when you set register type, indicates the order of the bytes in the two registers that is being used. Master and slave have to code the floating-point number in the same way in order to understand each other.

19.4.2 Time schedules in Modbus

It is possible to place time schedules in Modbus, so that they are adjustable from a superior system. Time schedules are a bit more complicated than other resources, therefore explained in detail in this

section.

To be able to lay out a time schedule in a Modbus mapping you have to first, in the time schedules settings, **check** the box that it should be allowed. You can only do that when **Modbus is inactive**. When the box is checked, you can no longer create new, or delete rules in the time schedule. You can only edit the rules that already exist. You must create the necessary rules before you check **”Enable in Modbus slave registers”**

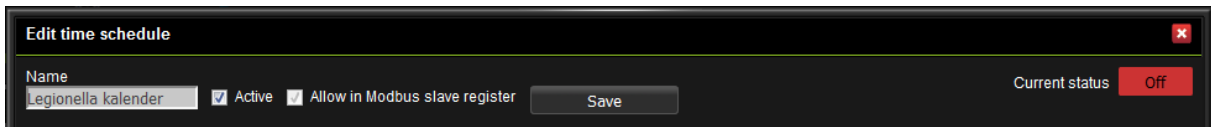

When pulling out a time schedule in the register list you choose both if you want to map out the status and active flag for the entire time schedule, and also which of the rules included in the time schedule you want to map out. Each rule will be several registers. How many and which depends on the type of rule.

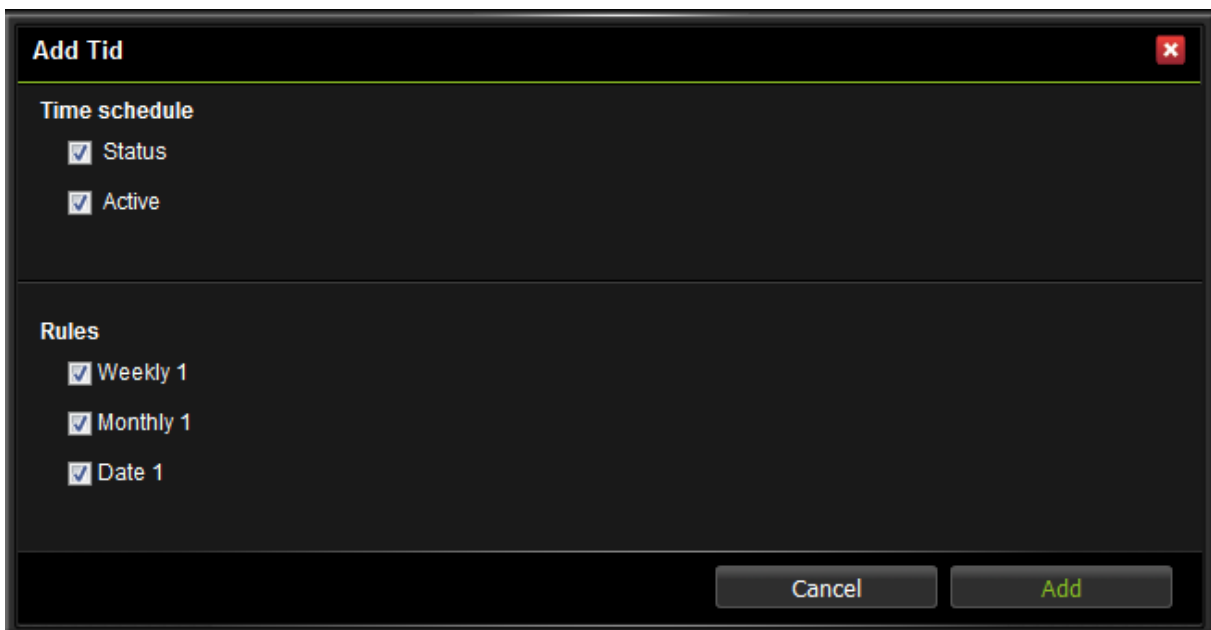

All registers associated with a time schedule has an extra delete multiple-icon next to the usual delete icon. If you hover your mouse over that icon all lines belonging to the same timetable are colored red. All lines belonging to the same rule becomes dark red. If you click on the icon, you get to choose whether you want to delete all the rows that belong to the time schedule, or all lines belonging to the same rule. One can just as usual Modbus lines move lines associated with a time schedule. The rows colors make it easy to see which ones belong together, and deleting an entire chart at once.

Registernummer	Resurstyp	Namn	Applikation	Typ	Skala	Läsa/Skriva
00001	Tidsschema.Status	Legionella kalender	Regulator	Word	1	Läsa
00002	Tidsschema.Aktiv	Legionella kalender	Regulator	Word	1	Läsa/Skriva
00003	Schemaregel.Typ och status	Legionella kalender.Veckovis 1	Regulator	Word	1	Läsa
00004	Schemaregel.Veckodagskod	Legionella kalender.Veckovis 1	Regulator	Word	1	Läsa/Skriva
00005	Schemaregel.Start timme	Legionella kalender.Veckovis 1	Regulator	Word	1	Läsa/Skriva
00006	Schemaregel.Start minut	Legionella kalender.Veckovis 1	Regulator	Word	1	Läsa/Skriva
00007	Schemaregel.Slut timme	Legionella kalender.Veckovis 1	Regulator	Word	1	Läsa/Skriva
00008	Schemaregel.Slut minut	Legionella kalender.Veckovis 1	Regulator	Word	1	Läsa/Skriva

The registers of time schedules may also need an explanation. The settings for the time and date are quite simple. Start times, stop times, cycle time, duration and offset are divided year, month, day(s), hours and minutes, depending on the type of rule. If you type an invalid value or a value that makes the rule invalid, the registry will either not be written at all, or the rule will be changed so that it becomes valid. If, for example, you enter a start time that is later than the end time, the end time will be set to the start time plus one second.

If you write 24 to the time register for an end time, hour, minute and second will be set to 23:59:59. It allows you to create registers that extends past midnight uninterrupted despite not having access to seconds via Modbus.

When you add a time schedule, you can select to use combined registers for hour and minute. Time 14:15 will then be represented by the decimal value 1415 in the register. This register replaces the separate registers for hour and minute. All values over 2400 are interpreted as 24:00 and stored as 23:59:59. 23:59:59 is also read in the register as 2400. If the minute value is set to 60 or higher, e.g. 14:68, then it's interpreted as 14:59:59. Times that matches XX: 59: 59 will be read as XX: 60 (if XX is less than 23).

Other registers are:

Register	Type	Description
Timing.Status	Read-only	One if the time schedules status is on, zero otherwise.
Timing.Active	Read and write	Time schedules activation check box. If active is zero will always be zero status , no matter what the rules say.

Register	Type	Description
Schedule.Rule type and status	Read-only	Specifies the type and status of a rule in a bit mask according to the table below
Schedule.Rule Weekday code	Read and write	Specifies which days of the week a weekly schedule is active, encoded according to the table below

Encoding of **Schedule.Rule type and status** according to following bit mask.

Bit	Meaning
0,1,2	1 = Weekly Schedule Rule 2 = Month Rule 3 = Year rule 4 = Date Rule 5 = Intermittent Rule
3	Reserved
4	Blocked (rule is not used)
5-13	Unused
14	Off-rule
15	Status

Status is one if the rule is on right now. For an off-rule (where bit 14 is one) the status is one if the rule allows that the schedule is active (Full schedule status is (TR1 OR TR2 OR ... TRN) AND (FR1 AND FR2 AND ... FRN) where TRx is a regular on rule and FRx is an off rule).

Encoding of weekdays in a **Schedule.Rule Weekday code** according to following bit mask.

Bit	Meaning
0	Monday
1	Tuesday

Bit	Meaning
2	Wednesday
3	Thursday
4	Friday
5	Saturday
6	Sunday

19.5 Modbus slave settings

Here you activate and edit the Modbus slave function.

The screenshot shows the configuration interface for the UltraBase30 device. The top navigation bar includes the IMSE UltraBase30 logo, notification icons, and the Abelko INNOVATION logo. The main content area is titled "Modbus slave settings" and contains three sections:

- Modbus slave:** A checkbox labeled "Enable Modbus slave" is currently unchecked. A "Save" button is located at the bottom right of this section.
- RS485 2:** Two radio buttons are present: "Use RS485 2 for GFBI" (unchecked) and "Use RS485 2 as Modbus RTU slave:" (checked). Below this, the "Modbus slave ID" is set to 0. A row of dropdown menus includes "Baudrate" (115200), "Number of bits" (8), "Parity" (None), "Stop bits" (1), and "Timeout [s]" (1). A "Save" button is at the bottom right.
- Ethernet:** A checkbox labeled "Activate Modbus TCP slave:" is checked. Below it, the "Port" is set to 502 and the "Timeout [s]" is set to 1. A "Save" button is at the bottom right.

Modbus slave

An Ultra can function both as a **Modbus RTU slave** on the **RS485 2** port for UltraBase30 and UltraBase40 or the **RS485** port for UltraBase20 and as a **Modbus TCP slave**. Define which values you want to be readable for which registers under the menu **Configuration, Modbus slave register** (see previous chapter for more details). Activate the Modbus slave function with the check box. You cannot

edit register settings while the Modbus slave function is activated.

Note! Before you can change the function of the RS485 port from Modbus **GFBI** to **RTU slave**, you first need to remove all units under the heading **RS485 2** (UltraBase30 and UltraBase40) and the heading **RS485** (UltraBase20) on the page **External units**.

RS485 2

The Ultra unit has a communication port marked **RS485 2**. This can either be used for external units, which are defined under the menu **Configuration, External units**, or used for the **Modbus RTU slave** function. **Activate** the **Modbus RTU slave** with the check box and set the communication settings for the port.

Ethernet

Modbus TCP communication is done over the network port marked **Ethernet**. **Port 502** is the default port number for a Modbus TCP server, but you can select a different port number.

The **Timeout** setting determines how long after the question has arrived the Ultra are allowed to send an answer. The Ultra will respond as soon as it can, but can sometimes be busy with other things. If it has not had time to respond before the timeout expire, it will send an exception code or does not respond at all. The system's master must wait until the slave timeout expire before sending a new question or send a question to any other device.

Warning! Modbus TCP is an unprotected protocol without authentication, password or encryption. If the port is opened to the Internet anyone can read and write in the Modbus registers.

19.6 Modbus TCP Gateway

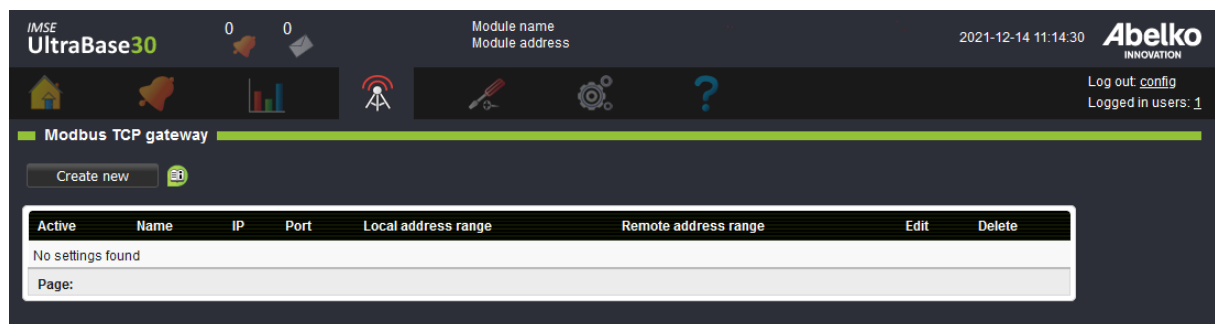

On this page, you create Modbus TCP gateways (hereinafter referred to as gateways) that are used on the page **External units**. These are used to direct the modbus communication towards specific IP addresses. In the Ultra, there are two ways to communicate via gateways; with separate communication queue and with shared communication queue.

Note! It is possible to create a maximum of 50 gateways.

Separate communication queue (recommended)

This means that parallel communication queues are created between the Ultra and each gateway's IP address, which makes the communication faster. When you create these, you get to name the gateway, it is this name that will appear as a separate heading on the page **External units** so you can easily connect the gateway to an external unit.

You can see which gateways that use a separate communication queue by them not having a **Local address range** or a **Remote address range** in the interface.

Shared communication queue

This means that a communication queue is used to communicate with several gateways, which makes the communication slower. Gateways with a shared communication queue require local and remote addressing, which means that **Start** and **Stop address** and **Offset** needs to be configured. External units placed under the heading **Modbus TCP Gateway** on the page **External units** will be handled by gateways with a shared communication queue.

Create new with Separate communication queue

1. Click **Create new** and enter **Name**, **IP address** and **port**. Name is used to easily identify different gateways.

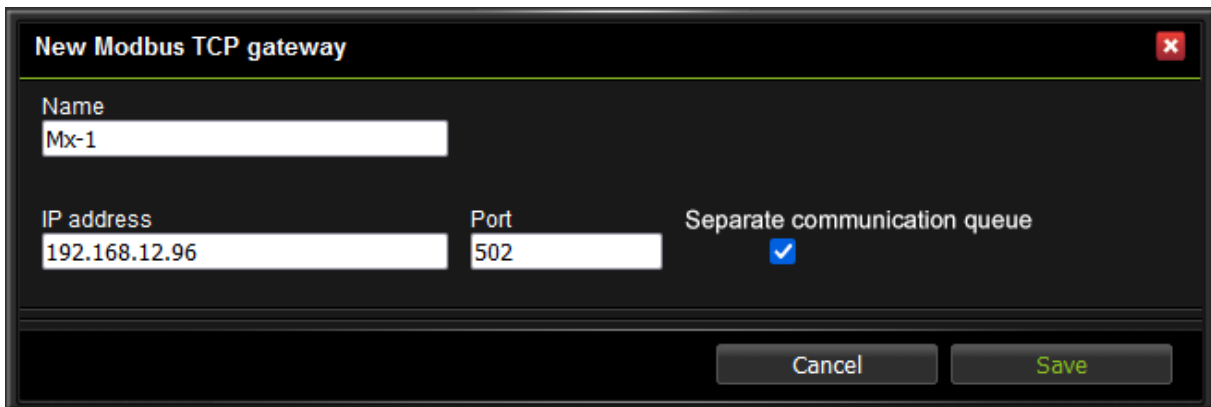

The screenshot shows a dialog box titled "New Modbus TCP gateway". It has a dark background and a title bar with a close button (red X). The dialog contains the following fields and controls:

- Name:** A text input field containing "Mx-1".
- IP address:** A text input field containing "192.168.12.96".
- Port:** A text input field containing "502".
- Separate communication queue:** A checkbox that is checked (blue checkmark).
- Buttons:** "Cancel" and "Save" buttons at the bottom right.

2. Select that you want to use **Separate communication queue**, this means that a separate communication queue is created between the Ultra and the unit.
3. Click **Save**.
4. The gateway must be **active** in order for it to work (the play symbol on the page **Modbus TCP gateway**). When a gateway is active, the Ultra tries to establish a TCP connection to it.

Active	Name	IP	Port	Local address range	Remote address range	Edit	Delete
	Mx-1	192.168.12.96	502				
	Mx-2	192.168.12.169	502				

Sida: 1

The gateway is now available as a heading on the page **External units**, where you can drag-and-drop communication definitions for external units.

- Expand the unit and go to **Address**. Under **Value**, enter the address of the external device, ie the addressing used on the RTU side of the gateway.

RS485 2

Modbus TCP: Mx-1, 192.168.12.96

Type IMSE_MxA12, 21466
Name Mx-1

Statistics		Information	
Inputs		Outputs	
Status channel	_OK	Address	1
Cable sequence number	0	Communication timeout	0
UI1	199904.10	AO1	0.00 V
UI2	199959.01	AO2	0.00 V
UI3	199979.46	AO3	0.00 V
UI4	200053.57	AO4	0.00 V
UI5	200002.08		
UI6	199999.39		
UI7	199938.00		
UI8	200010.21		

Create new with shared communication queue

In this example we create two gateways, Mx-1 and Mx-2.

- Click **Create new** and enter **Name**, **IP address** and **port**. Name is used to easily identify different gateways.

New Modbus TCP gateway ✕

Name
Mx-1

IP address: 192.168.12.96 Port: 502 Separate communication queue:

Start address: 1 Stop address: 50 Offset: 0

Cancel Save

New Modbus TCP gateway ✕

Name
Mx-2

IP address: 192.168.12.169 Port: 502 Separate communication queue:

Start address: 51 Stop address: 100 Offset: -50

Cancel Save

2. Enter **Start address** and **Stop address**. These settings decide which Modbus addresses this gateway is used for, ie which **Local address range** is used internally in the Ultra. Offset is used to convert a **Local address range** to a **Remote address range**, ie the addressing used on the RTU side of the gateway.
3. Click **Save**.

Active	Name	IP	Port	Local address range	Remote address range	Edit	Delete
	Mx-1	192.168.12.96	502	1 - 50	1 - 50		
	Mx-2	192.168.12.169	502	51 - 100	1 - 50		

Page: 1

In the example above, we have chosen to create two gateways. External units with an address between 1-50 communicate via gateway Mx-1 with IP address 192.168.12.96. External units with an address

between 51-100 communicate via gateway Mx-2 with IP address 192.168.12.169. An offset (-50) means that they correspond to address 1-50 on the receiver's RTU bus.

If you only have one Modbus TCP gateway to communicate with, you can preferably set the address range to 1-253 and offset 0.

4. The gateway must be **active** in order for it to work (the play symbol on the page **Modbus TCP gateway**). When a gateway is active, the Ultra tries to establish a TCP connection to it.
5. Go to page **External units** under **Configuration**. Drag-and-drop units under the heading **Modbus TCP Gateway**.
6. Expand the unit and go to **Address**. Under **Value**, enter the local address for the external unit. Click **Save**.

The screenshot displays two Modbus TCP Gateway configuration panels. The top panel is for gateway Mx-1 (Type IMSE_MxA12, 21466) and the bottom panel is for gateway Mx-2 (Type IMSE_MxDI12, 21464). Both gateways are active, indicated by a play button icon. Each panel shows a table of inputs and outputs. In the Mx-1 panel, the 'Address' field for the first output (AO1) is set to 1. In the Mx-2 panel, the 'Address' field for the first output (DI1) is set to 51. Both values are circled in red in the original image.

Gateway	Type	Name	Address
Mx-1	IMSE_MxA12, 21466	Mx-1	1
Mx-2	IMSE_MxDI12, 21464	Mx-2	51

In this example, units that are to communicate via gateway Mx-1 needs to have **Address** set to a value

between 1-50 and units that are to communicate via gateway Mx-2 needs to have Address set to a value between 51-100.

Move gateway from shared communication queue to separate communication queue

Active	Name	IP	Port	Local address range	Remote address range	Edit	Delete
	Mx-1	192.168.12.96	502	1 - 50	1 - 50		
	Mx-2	192.168.12.169	502	51 - 100	1 - 50		

Page: 1

In this example, we want to move the gateways Mx-1 and Mx-2 which have a shared communication queue, to gateways that have separate communication queues. Mx-2 has an addressing that uses an offset (-50) which means that its remote address range is connected to a local address range where 1 = 51, 2 = 52 and so on. This mapping was needed to connect external units to a specific gateway. Now that we switch to separate communication queues, we no longer need this mapping.

1. Start by clicking **Create new** and enter **Name**, **IP address** and **port**. Enter the same IP address and port as the old gateway.

The dialog box is titled "New Modbus TCP gateway" and has a close button (X) in the top right corner. It contains the following fields and options:

- Name: Mx-1
- IP address: 192.168.12.96
- Port: 502
- Separate communication queue:

At the bottom, there are "Cancel" and "Save" buttons.

The dialog box is titled "New Modbus TCP gateway" and has a close button (X) in the top right corner. It contains the following fields and options:

- Name: Mx-2
- IP address: 192.168.12.169
- Port: 502
- Separate communication queue:

At the bottom, there are "Cancel" and "Save" buttons.

2. Select that you want to use **Separate communication queue**. Click **Save**.

- Note the old gateway's remote address range. If it used an **Offset**, this needs to be configured for the unit on the page **External units**.
- Stop the old gateways and start the new gateways.

Active	Name	IP	Port	Local address range	Remote address range	Edit	Delete
	Mx-2	192.168.12.169	502				
	Mx-1	192.168.12.96	502				
	Mx-1	192.168.12.96	502	1-50	1-50		
	Mx-2	192.168.12.169	502	51-100	1-50		

Sida: 1

Go to page **External units** under **Configuration**. Now you can drag-and-drop units from the heading **Modbus TCP Gateway** to the new headings **Modbus TCP: Mx-1, 192.18.12.96** and **Modbus TCP: Mx-2, 192.18.12.169**.

The screenshot shows a configuration interface with a grid background. At the top, there is a section titled "Modbus TCP Gateway". Below it, two units are listed, each with a play button icon, a type name, and a value:

- Type IMSE_MxA12, 21466; Name Mx-1
- Type IMSE_MxDI12, 21464; Name Mx-2

A dashed red box encloses these two units, indicating they are being dragged. Below this, there are two sections with headings:

- Modbus TCP: Mx-2, 192.168.12.169
- Modbus TCP: Mx-1, 192.168.12.96

Each heading is followed by several empty rows, suggesting a table or form for configuring the units.

- Expand the unit and click **Address**. Under **Value**, enter the remote addressing that the old gateway had. If the gateway had an offset, the address needs to be adjusted for this to get the addressing of the physical unit, otherwise the unit incorrectly remains on the internal address-

sing.

In this example, the unit Mx-2 was set to address 51. Since the gateway no longer uses local addressing or offset, the **Value** of the new address should be 1. Click **Save**. The Mx-1 does not need a new **Value** under **Address** since its gateway did not use an offset.

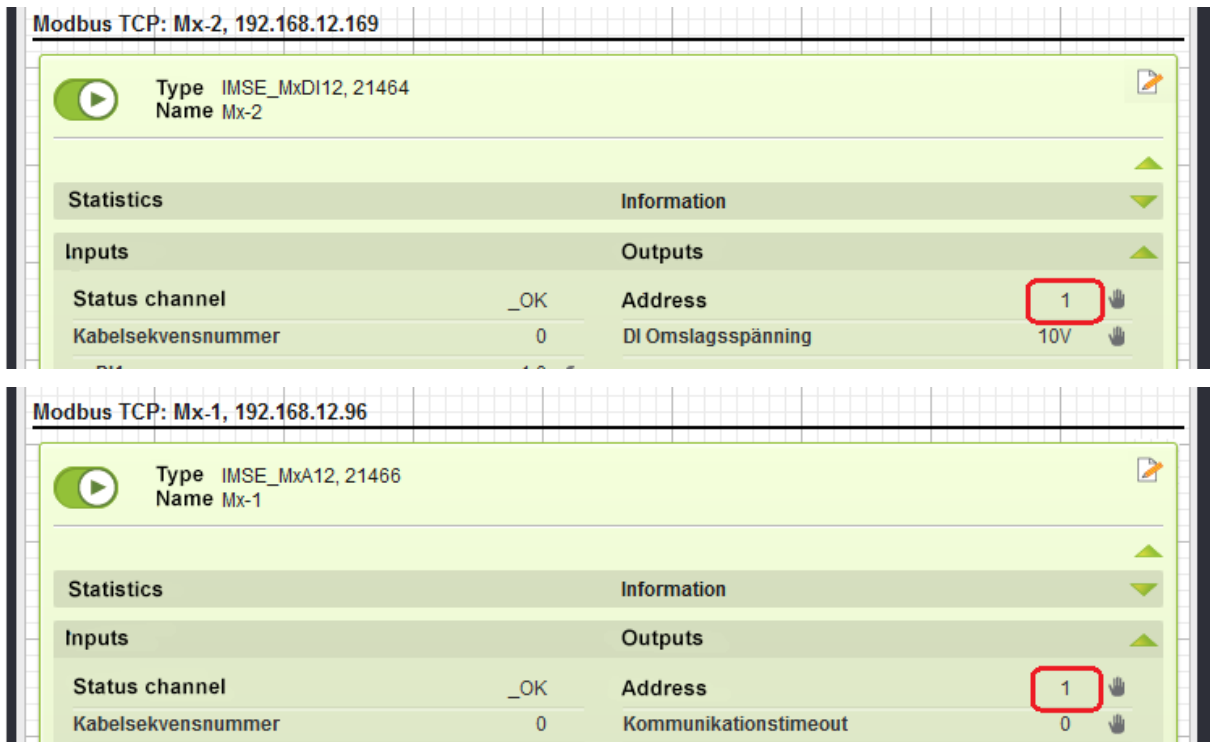

7. Now you can go back to page **Modbus TCP gateway** and delete the old gateways.

Active	Name	IP	Port	Local address range	Remote address range	Edit	Delete
	Mx-2	192.168.12.169	502				
	Mx-1	192.168.12.96	502				

19.7 RS485 Ex settings

On this page, the EX-port is configured. The EX-port can either be used for expansion modules, under **In- & Outputs**, or as an RS485-port for **External units**. If it is used for External units, it is recommended to use an ExConnect module for conversion from modular cable to screw terminal.

19.8 External devices sendouts

On this page, you create sendouts for external devices. This is a function that periodically sends email with all values for all external devices of a particular type. The function is primarily intended to be used to send meter indications to automatic collection systems, such as invoicing. You can collect information from many meters without having to connect them to channels or logs.

What's included in the sendout is the external device name, when it was last updated, status and value.

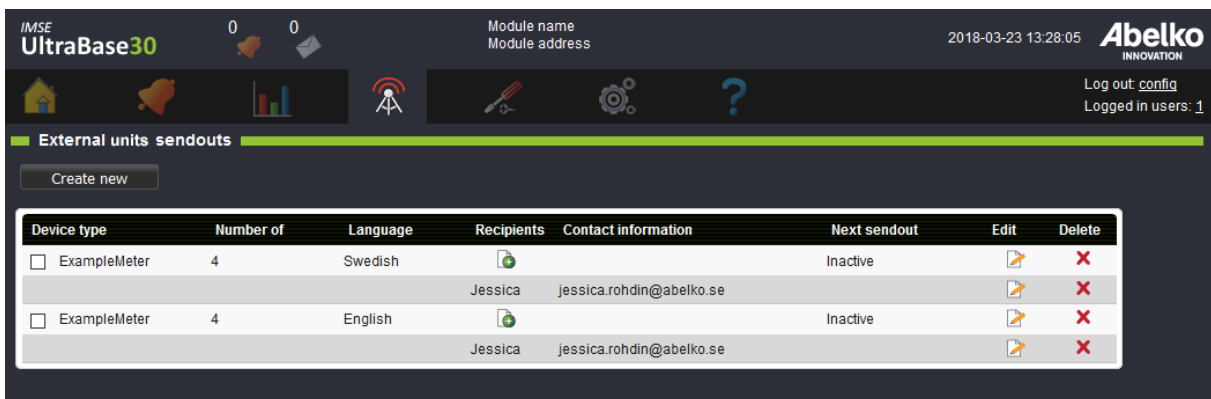

The screenshot shows the 'External units sendouts' configuration page in the IMSE UltraBase30 interface. The page has a dark theme with a green header bar. At the top, there are navigation icons and a 'Create new' button. Below this is a table with the following columns: Device type, Number of, Language, Recipients, Contact information, Next sendout, Edit, and Delete. The table contains two rows of data:

Device type	Number of	Language	Recipients	Contact information	Next sendout	Edit	Delete
<input type="checkbox"/> ExampleMeter	4	Swedish		Jessica jessica.rohdin@abelko.se	Inactive		
<input type="checkbox"/> ExampleMeter	4	English		Jessica jessica.rohdin@abelko.se	Inactive		

1. Start by creating a new sendout by clicking **Create new**.
2. Enter **Device type** and choose **Language** for the email.
3. Choose how often you want the email to be sent, **Periodically** or **Monthly**.
4. Click **Save**.
5. Add **Recipients** (you create new recipients under the menu Communication and Recipients).
6. Now the recipients will receive a sendout from the external device. To test the message, go to **Edit** on a device and click **Send Now**.

The values that are being sent is the last read value. Information about the device status and when the last reading was done is also included (see example below).

Note that it is the value read from the device that is sent, without any scaling in the IO-channel applied (the raw value).

Modulnamn, Moduladress
00-30-5E-0B-01-A2
10, ExampleMeter, ExampleMeter

000	Name	Last updated	Status	Serial number ()	Meter Reading (kWh)
024	Mätare LGH1	2018-03-14 16:46:06	(OK)	123575.000000	106664.000000
025	Mätare LGH2	2018-03-14 16:46:06	(OK)	123459.000000	100168.000000
026	Mätare LGH3	2018-03-14 16:46:03	(OK)	123463.000000	100392.000000

19.9 Portal Update

This is a function that, together with a portal server, such as portal.abelko.se, helps keep track of the unit's IP address.

The screenshot shows the 'Portal update' configuration page in the IMSE UltraBase30 interface. The page has a dark header with the 'IMSE UltraBase30' logo, notification icons, and the 'Abelko INNOVATION' logo. The main content area is titled 'Portal update' and contains a 'Create new' button. Below this is a form with the following fields:

- Name:** A text input field.
- Interval:** A dropdown menu currently set to 'Disabled'.
- Host:** A text input field.
- Port:** A text input field with the value '80'.

Below the form is a table with the following columns: Status, Last update, Last update try, and ID number. The table currently shows one entry with the status 'Not updated' and dashes in the other columns. A 'Save' button is located at the bottom right of the form area.

Enter a name, and set how often you want the unit to update its address with the server. If you use a mobile subscription or have a connection that changes the IP address frequently, set a short interval. If you have a connection that does not change the address very often, such as fiber or DSL, set a high interval.

On our portal portal.abelko.se, you can use the units MAC address, view its current IP address and view when the unit was last connected to the server and updated it. When you found your unit (using the units MAC address), save the result page as a bookmark. This gives you a link that is updated with the most recent address as long as the unit is connected to the Internet.

Please note that the portal service only gives you a link to the product, you do not surf through the portal.

19.9.1 Status

Under status, view when the last update and last update attempt was made. Normally, these two dates are the same, but when the unit fails to update, these dates differ and the status will be **Failed**. Statuses can have the following values:

- **Inactive:** the function is not activated.
- **Updated:** the function is activated and the last update successful.
- **Update error:** the function is activated but the last update failed. The most common reason why the device fails to update is that it does not connect to the Internet or that it cannot name dissolve the portal server. You can start the troubleshooting in the **Network** menu under **Communication** to check that **Gateway** and **DNS** is correctly set.
- **Update denied by server:** the function is activated and the unit had a connection to the server, but the server denied the unit from updating its address. This will happen when you use a service duty where you have to manually add units, for example Comprobo.
- **Internal error:** the function is activated but something unspecified has prevented the device from updating its address in the portal server.

Remember to check that the unit is accessible in both ends. This usually means that you have to open ports in your router or firewall.

19.10 Companion

You can use the companion function to see active alarms, alarm history, overviews and summary pages from many IMSE Ultra devices in the user interface of one Ultra. This enables a good overview of a plant without the user needing to log in to several devices and switching between tabs. To achieve this you configure all devices as companions to one main companion device that can show all information.

A main companion can display information from up to ten other devices. These are configured to connect to the main companion, and give it information access. A user that logs in at the main companion automatically has access to settings in all companions with the same access level.

When companions are configured they exchange cryptographic keys in a pairing procedure. After that, both sides can be sure of the identity of the other side when they henceforth connect automatically. The communication is encrypted and is safe to use over public networks.

An IMSE Ultra device can be simultaneously be a main companion for ten devices, and share information as a companion to ten other devices.

19.10.1 Configuring connected devices

If all devices in the plant are online, you can configure companionship using the following steps:

In the main companion device

1. Go to the Communication / Companion menu, tick the check box **Activate to retrieve from other companions** under **My main companions I retrieve from** and click on **Save**.
2. Select **Assisted connection** and tick the check box **Show available companions...**

The screenshot shows the 'Companion' configuration page in the IMSE UltraBase30 web interface. The page is titled 'Companion' and has a dark header with the IMSE UltraBase30 logo, notification icons, and the Abelko logo. The main content area is divided into two sections: 'My main companions I share to' and 'My companions I retrieve from'. The 'My main companions I share to' section has an 'Add new' button and a table with columns: Active, Status, Name, Address, Identity, Edit, Delete. The 'My companions I retrieve from' section has a 'Save' button, a 'Settings' dropdown, and two radio button options: 'Assisted connection' (selected) and 'Manual connection'. The 'Assisted connection' option has a checked checkbox and a description. Below it is an 'Add new' button and another table with columns: Active, Status, Name, Address, Identity, Serial number, Edit, Delete.

In the devices that the main companion will get data from

3. Under Communication / Companion and the heading **My companions I share to**, click the **Add new** button.
4. In the popup dialog, set a name for the main companion, enter the IP-number for the main companion and make sure that the Port setting is the same as in the main companion. The Identity field can be left blank. Click on **Save**.

Main companion ✕

Name	Address	
<input type="text" value="Main companion 1"/>	<input type="text" value="192.168.12.50"/>	
Port	Identity	<input type="checkbox"/> Set manual identity.
<input type="text" value="7503"/>	<input type="text"/>	

- Click on the play button under **Active** for the newly created main companion connection to activate it. It will then start to connect, and the status should change to **Awaits pairing**.

IMSE
UltraBase30

Module name
Module address

2018-11-23 13:12:21

Abelko
INNOVATION

Log out: [config](#)
Logged in users: 2

Companion

My main companions I share to

Active	Status	Name	Address	Identity	Edit	Delete
	Awaits pairing	Main companion 1	192.168.12.50			

My companions I retrieve from

Activate to collect from other companions

Settings ▼

Assisted connection

Enable connections from companions not yet accepted or manually added. To use automatic connection you need to do this during the connection phase.

Manual connection

Active	Status	Name	Address	Identity	Serial number	Edit	Delete
No companions found							

Return to the main companion device. The device you just created a connection in should be listed as available companions. Click on the **Add** button to invite the device as a companion and request pairing. Status should change to **Pairing requested**.

IMSE UltraBase30 0 0 Module name Module address 2018-11-23 13:17:09 Abelko INNOVATION Log out: config Logged in users: 1

Companion

My main companions I share to

Add new

Active	Status	Name	Address	Identity	Edit	Delete
No companions found						

My companions I retrieve from

Activate to collect from other companions Save

Settings

Assisted connection

Enable connections from companions not yet accepted or manually added. To use automatic connection you need to do this during the connection phase.

Manual connection

Add new

Active	Status	Name	Address	Identity	Serial number	Edit	Delete
	Pairing requested	Module name	192.168.12.120	SEEBAA52BF77C00125B7F0B	66		

The last step to get things working is to go to the invited companion devices and click **Accept Pairing** on the corresponding main companion connection row. The two devices will then be paired and will automatically try to reconnect to each other whenever the connection is lost. The status on both sides should be **Connected**.

IMSE UltraBase30 0 0 Module name Module address 2018-11-23 13:24:15 Abelko INNOVATION Log out: config Logged in users: 2

Companion

My main companions I share to

Add new

Active	Status	Name	Address	Identity	Edit	Delete
	Connected	Main companion 1	192.168.12.50	\$F153A547F79200125B340B		

My companions I retrieve from

Activate to collect from other companions Save

Settings

Assisted connection

Enable connections from companions not yet accepted or manually added. To use automatic connection you need to do this during the connection phase.

Manual connection

Add new

Active	Status	Name	Address	Identity	Serial number	Edit	Delete
No companions found							

End the process by unticking the **Enable connections from companions...** check box in the main companion.

19.10.2 Configuring before plant is connected

If you want to configure companionship before the devices are online, you need to know which IP-address the main companion will get.

In the main companion:

1. Tick the check box **Activate to retrieve from other companions** under **My companions I retrieve from** and click on **Save**.
2. Choose **Manual connection** and click the **Add new** button under **My companions I retrieve from**.
3. Give the companion a name, enter a unique identity and click **Save**.

Companion

Name	Identity
Companion 2	Unique identity

Cancel Save

4. Activate the function by clicking the play button under Active and make sure it is green.

In the companions:

5. Under Communication / Companion and the heading **My main companions I share to**, click the **Add new** button.
6. Create a connection to the main companion in the same way as the assisted procedure above. Tick **Set manual identity**, enter the exact same identity as in the main companion and click **Save**.

Main companion

Name	Address
Main companion 2	192.168.12.50
Port	Identity
7503	Unique identity

Set manual identity.

Cancel Save

7. Activate the function by clicking the play button under **Active** and make sure it is green.

The last step, pairing, cannot be completed until the devices are online on the correct network.

8. Start in the main companion. If things are set up correctly, the companions listed under **My companions I retrieve from** have status **Awaits pairing** and the **Add** button visible. Click **Add** to start the pairing.

IMSE UltraBase30 0 0 Module name Module address 2018-11-23 13:48:24 Abelko INNOVATION Log out: config Logged in users: 1

Companion

My main companions I share to

Add new

Active	Status	Name	Address	Identity	Edit	Delete
No companions found						

My companions I retrieve from

Activate to collect from other companions Save

Settings

Assisted connection
 Enable connections from companions not yet accepted or manually added. To use automatic connection you need to do this during the connection phase.

Manual connection
Add new

Active	Status	Name	Address	Identity	Serial number	Edit	Delete
	Pairing requested	Module name	192.168.12.120	Unique identity	66		

9. Accept the pairing in the companion by clicking the **Accept** button.

19.10.3 View alarms

Alarms in active companions will be displayed in a separate alarm icon at the top of the interface. The icon works in the same way as the other icon for active alarms.

With active companions, the appearance of the Active alarms and Alarm history pages will change. There will be check boxes for each companion device, including the main device you are logged in to, above the alarm lists. You can use them to filter which devices you want to see alarms from.

There is also a new column in the list, **Device Name**, to show which device an alarm belongs to. The names used in the table and for the check boxes are the devices settings for Module name. It is set in the menu System / Settings, and is the name showed in top row of the web page.

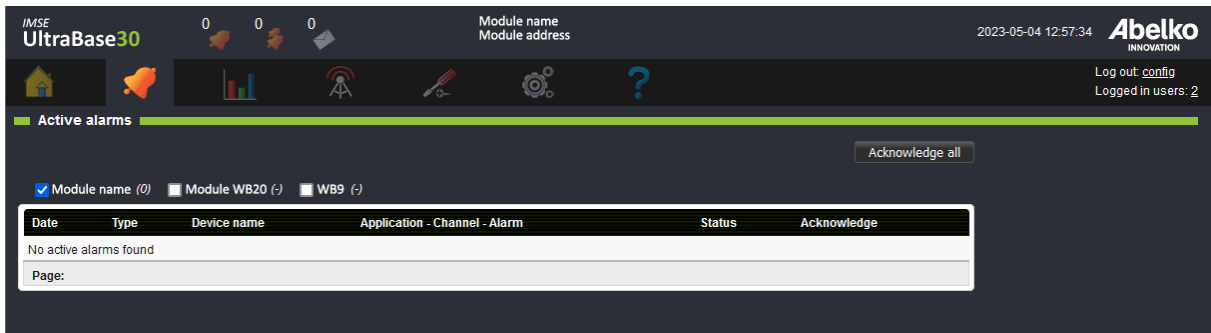

19.10.4 Home, overviews and summary pages

On the home page there is normally a tree view that enables access to overviews and summary pages. When companions are active, there is an additional tree for each companion device. For each companion there is also a counter for active alarms in that device. These tree menus works just as normal, and are shown as they are shown in the devices they originally come from.

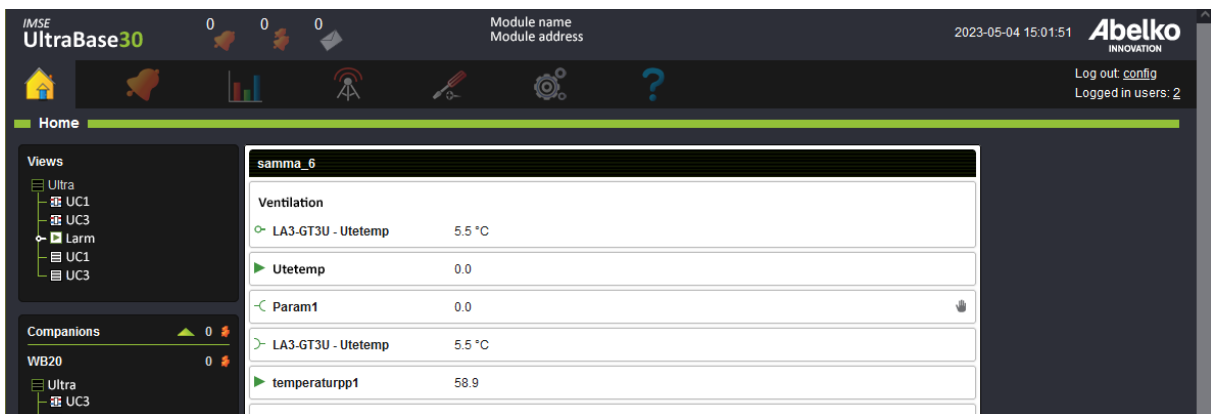

19.10.5 Safety

The pairing procedure described above involves the devices exchanging cryptographic keys. Both devices can thereafter verify that it is the correct device they are communicating with. The traffic between them is TSL-encrypted.

If something goes wrong with the pairing, it has to be done again manually. Do not initiate or accept pairing unless you are sure that it is the correct device you are pairing with.

A user in the main companion has access to all functions in companion devices at the same access level as logged in. A companion has an analogue left the keys to its house to the main companion, and trusts it not to do anything bad.

If the connection between companions is made through a router, the port used to access the main companion must be opened.

20 IMSE Ultra OP



IMSE Ultra OP is an operator panel that can be connected to your Ultra base unit. This allows you to quickly and easily on site access your summaries to get an overview of the system and edit settings.

20.1 Connection and function overview

The operator panel is connected to the Ultra's MOD connector and can be mounted as a handheld panel with magnets, or panel mounted on a cabinet door.

When the operator panel is connected, a menu system consisting of fixed menus and menus created from the summaries visible in the tree structure on the web page home menu are shown. The operator panel can not display images or graphics, so only those elements of the summary pages that can be represented with text menus appear.

When the operator panel is not being used, the display backlight turns off after a while and the operator panel goes into a sleep mode in which the name of the plant and number of alarms and manual controls are presented on the display. The display turns on as soon as a button is pressed.

The LEDs for status, A and B alarms mirrors the corresponding LEDs on the Ultra base unit.

20.2 Get started with your operator panel

In order to change values and settings in the operator panel, you need to enter a four-digit password. The default password is 1234 and can be changed from both the website and from the operator panel.

The panel begins to work as soon as it is plugged in, without any special settings.

A prerequisite is that the Ultra is updated to R1.35 or later. If necessary, it will load the correct version of the software into IMSE Ultra OP from Ultra base unit when it starts. This means that you can easily move an operator panel between different Ultra units.

In order to change settings for the panel, go to **System** and **Operator Panel** in your Ultra. Here you can set password and language for the user interface. You can also change these settings in operator panel menus **System** and **Language**.

20.3 Menu overview

The menus in the operator panel are structured as following:

Active alarms View and acknowledge active alarms

Alarm History View alarm history as a list

Summaries Under the menu Alarm History the Ultras summaries are listed. They have the same name that was specified when they were created. Which summaries you want to access can be set separately for the panel (see chapter Custom menus).

Manual override View available manual overrides, active manual overrides and activate/inactivate these.

Network Network Settings

Modbus slave settings Settings for Modbus slave functionality

System Settings Clock settings, NTP, passwords and system information

Language Change language for the operator panel

20.4 Custom menus

If you want to customize the menus that will appear on your operator panel, you can do this in your Ultra.

1. Go to menu **System** and **Operator Panel** in your Ultra.

2. Click **Edit** under **Operator menu**.
3. Drag and drop summaries you want to be able to access via the operator panel.
4. You can group summaries by adding a **Node** via the tool panel to the right. Name the node and click **OK**. Now you can place summaries under the node.
5. When you are happy with the design, click **Save**.

Now, these summaries will be visible on the operator panel. If you delete all the nodes in your custom menu, the operator panel goes back to display the same summaries visible on the ultras home page.

21 Technical Specification IMSE UltraBase20

21.1 Temperature Inputs

There are 6 resistance measurement inputs used to measure temperature. Measurement range and accuracy, see chapter [# Resistance measurement range]

Temperature inputs can also be used as digital status inputs for potential-free switches.

21.2 Analog inputs

There are two analog inputs that can be configured to measure either 0 to 10 V voltage, or 0 to 20 mA current.

Voltage measurement:

- Input impedance: 22 k Ω
- Accuracy: 100 mV
- Measurement range: 0-10 V
- Resolution: better than 0.4 mV

Current measurement:

- Input impedance: 235 Ω
- Accuracy: 0.2 mA
- Measurement range: 0-24 mA
- Resolution: better than 2 μ A
- Max continuous input current: 30 mA

21.3 Digital Inputs

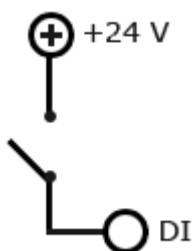

There are 5 digital inputs.

All digital inputs have the following specifications:

- Input resistance: 10 k Ω
- Digital input: Switch level from 4 V or 12 V configurable
- Pulse counter: Max 200 Hz, at least 2.5 ms pulse width
- Frequency input: 0-200 Hz, 2.5 ms pulse width
- An open input (not connected) is actively low

21.4 Analog outputs

There are 4 analog outputs. Their specifications are:

- Output signal: 0-10 V
- Resolution: 10 bits
- Max output current: 2 mA
- Accuracy: ± 100 mV

The outputs can be manually controlled using dials on the front panel.

21.5 Digital relay outputs

There are three relay outputs. Rating 250 VAC / 2 A, or 30 VDC / 2 A for resistive load. The relays can be manually controlled with switches on the front panel.

21.6 Communication

21.6.1 Ethernet

IEC 802.3 10/100 Mbit/s, RJ45 Connector

Cable: Category 5 shielded cable, max 100 m

21.6.2 Ethernet Local PC

IEC 802.3 10/100 Mbit/s, RJ45 Connector

Cable: Category 5 shielded cable, max 100 m

The IMSE UltraBase20 acts as a DHCP server on this port. Intended as a service port for direct connection to a PC. Server address 192.168.142.1.

21.6.3 RS485

The RS485 port is intended to be used for field bus communication.

- Connection: 5 mm screw terminals
- Communication speed: 300 to 115200 baud
- Max cable length: 1200 m (at 19200 baud and using twisted pair shielded cable)

21.6.4 Ex Out

RJ12 connector intended for connecting IMSE Ex expansion modules.

- Protocol: AeACom
- Max cable length: 10 m
- Max number of expansion modules: 10

21.6.5 MBus

There is one MBus mini master port.

- Standard: EN 13757-2, ch 4.4 mini-master
- Capacity: Max 10 unit loads
- Communication speed: 300 or 2400 baud

21.7 Processor unit

- Processor type: ARM Cortex A7
- Operating system: Linux
- RAM: 512 Mbyte
- Flash: 8 GByte
- Real time clock power backup time, min 1 day, typically 7 days.

21.8 Other

Power supply:

- 24 VDC +- 10%, 1.5 A
- 24 VAC, 50 Hz, 10 VA

Power consumption:

- Typ 2 W with DC-supply (excluding accessories)
- Typ 2.5 W with AC-supply (excluding accessories)

Ambient temperature range: 0 °C to +50 °C

Humidity: max 90 %, non condensing

Case: 9 modules DIN case, 156x85x60 mm, IP21

Weight: 0.3 kg

22 Technical Specification IMSE UltraBase30

22.1 Universal Inputs

There are 16 universal inputs. These can be used for:

- Analog voltage input: 0-10 V
- Analog current input: 0-24 mA
- Resistance input (for temperature measurement): Measurement range and accuracy, see chapter Resistance measurement range.
- Resistance input: 80-249 k Ω (for temperature measurement)
- Digital status: for potential-free sensors

The resistance input has four different areas that can either be selected automatically or selected manually.

The inputs are designed for up to 10 V.

Current measurement:

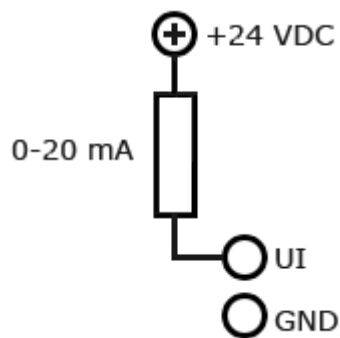

- Measuring range: 0-24 mA
- Resolution: better than 2 μ A
- Accuracy: $\pm 0,25$ %, of full scale
- Input impedance: 235 Ω for current
- Max input signal cont: 30 mA for current

Digital in:

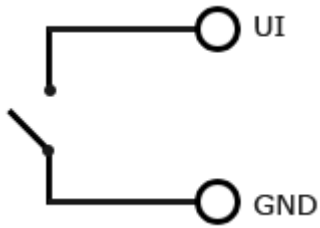

- For short-circuit sensors, on at 150 Ω , off at 200 Ω
- Applied voltage 2 V, short circuit current 1 mA
- Not frequency input
- Not pulse counter
- Min pulse width: 1 sec
- An open input (not connected) is actively low

Voltage measurement:

- Input impedance: 210 kohm
- Accuracy: 100 mV
- Measuring range: 0-10 V
- Resolution: Better than 0.4 mV

Resistance measurement:

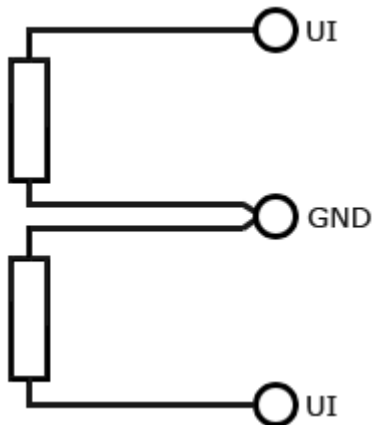

22.2 Digital Inputs

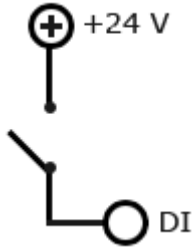

There are 4 digital inputs.

- All digital inputs have the following specifications:
- Input resistance: 10 k Ω
- Digital input: Switch level from below 3 V to over 4 V
- Pulse counter: Max 200 Hz, at least 2.5 ms pulse width
- Frequency input: 0-200 Hz, 2.5 ms pulse width
- An open input (not connected) is actively low

22.3 Analog outputs

There are 6 analog outputs. Their specifications are:

- Output signal: 0-10 V
- Resolution: 10 bits
- Max output current: 2 mA
- Accuracy: ± 100 mV

22.4 Digital outputs

There are 4 digital outputs. Their specifications are:

- Output: Open drain
- Max current: 0,4 A
- Max voltage: 36 V

22.5 Communication

22.5.1 Ethernet

IEC 802.3 10/100 Mbit/s, RJ45 Connector

Cable: Category 5, max 100 m

22.5.2 Ethernet Local PC

IEC 802.3 10 Mbit/s, RJ45 Connector

Cable: Category 5, max 100 m

The IMSE UltraBase30 acts as a DHCP server on this port. Intended as a service port for direct connection to a PC. Server address 192.168.142.1.

22.5.3 RS485

There are two RS485 ports intended to be used for field bus communication.

- Connection: 5 mm screw terminals
- Communication speed: 300 to 115200 baud
- Max cable length: 1200 m (at 19200 baud)

22.5.4 Ex Out

RJ12 connector intended for connecting IMSE Ex expansion modules.

- Protocol: AeACom
- Max cable length: 10 m
- Max number of expansion modules: 10

22.6 Processor unit

- Processor type: Arm9
- Operating system: Linux
- RAM: 128 Mbyte
- Flash: 512 MByte
- Real time clock power backup time, min 1 day, typically 7 days.

22.7 Other

- Power: 24 VDC +/- 10 %, typically 2 W
- Ambient temperature range: -20 °C to +50 °C
- Humidity: max 90 %, non condensing
- Case: 9 modules DIN case, 156x85x60 mm, IP21
- Weight: 0.3 kg

23 Technical Specification UltraBase30+

	UltraBase30+
Supply voltage	24 VDC
Power consumption, typical	2,4 W
Power consumption, max	7,2 W
Power consumption, max with external units	43 W
Ingress protection	IP20
Operating temperature range	-20 to +50 °C
Humidity	Max 90 % rel. humidity, non condensing
Pollution degree	1
Maximum altitude	2000 m
Module width	9
Mounting	DIN-rail
EMC approvals	EN 61326-1
Communication	
Ethernet	10/100/1000 Mbit/s
Local PC (USB-C)	Ethernet over USB
Ex-modules	Modular cable, RJ12 6/6
RS485 1, RS485 2	Plug in screw terminal
USB-A	USB-storage
Digital inputs (4)	
Switching level	To: < 3 From: > 4 V
Hysteresis	0,5 V
Pulse counter frequency	0-200 Hz
Minimum pulse width	2,5 ms
Frequency accuracy	±0,5 %
Universal inputs (16)	
Digital input function	Close to GND
Voltage range	0-10 V
Current range	0-20 mA
Resistance range	80-249 kΩ
Analog outputs (6)	
Range	0-10 V, 2 mA
Digital outputs (4)	
Digital output function	Open drain
Max current	0,4 A
Max voltage	36 V

24 Technical Specification IMSE UltraBase40

24.1 Temperature Inputs

There are 8 resistance measurement inputs used to measure temperature. They can measure resistive temperature sensors in the range 800 till 1600 Ω , which for a Pt1000 sensor corresponds to approximately -50 to +150 $^{\circ}\text{C}$.

The accuracy is better than 1 Ω between 800 Ω and 1000 Ω . Above it is limited by the line from 1 Ω at 1000 Ω and 2 Ω at 1600 Ω .

Temperature inputs can also be used as digital status inputs for potential-free switches.

24.2 Analog inputs

There are 8 analog inputs that can be configured to measure either 0 to 10 V voltage, or 0 to 20 mA current.

Voltage measurement:

- Input impedance: 110.4 k Ω
- Accuracy: 100 mV
- Measurement range: 0-10 V
- Resolution: better than 0.4 mV

Current measurement:

- Input impedance: 235 Ω
- Accuracy: 0.2 mA
- Measurement range: 0-24 mA
- Max continuous input current: 30 mA

24.3 Digital Inputs

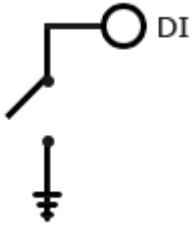

There are 8 digital inputs.

All digital inputs have the following specifications:

- Digital input: Switch level between 5-6 V.
- Pulse counter: Max 200 Hz, at least 2.5 ms pulse width
- Frequency input: 0-200 Hz, 2.5 ms pulse width

24.4 Analog outputs

There are 8 analog outputs. Their specifications are:

- Output signal: 0-10 V
- Resolution: 10 bits
- Max output current: 2 mA
- Accuracy: ± 100 mV

24.5 Digital outputs

There are 8 digital outputs.

- Open drain with breaking capacity 0.5 A and 24 VDC with resistive load

24.6 Communication

24.6.1 Ethernet

IEC 802.3 10/100 Mbit/s, RJ45 Connector

Cable: Category 5 shielded cable, max 100 m

24.6.2 Ethernet Local PC

IEC 802.3 10/100 Mbit/s, RJ45 Connector

Cable: Category 5 shielded cable, max 100 m

The IMSE UltraBase acts as a DHCP server on this port. Intended as a service port for direct connection to a PC. Server address 192.168.142.1.

24.6.3 RS485

There are 2 RS485 port intended field bus communication.

- Connection: 3.5 mm screw terminals
- Communication speed: 300 to 115200 baud
- Max cable length: 1200 m (at 19200 baud and using twisted pair shielded cable)

24.6.4 Ex Out

RJ12 connector intended for connecting IMSE Ex expansion modules.

- Protocol: AeACom
- Max cable length: 10 m
- Max number of expansion modules: 10

24.7 Processor unit

- Processor type: ARM Cortex A7
- Operating system: Linux
- RAM: 512 Mbyte
- Flash: 8 GByte
- Real time clock power backup time, min 1 day, typically 7 days.

24.8 Other

Power supply:

- 24 VDC +- 10%, 1.5 A
- 24 VAC, 50 Hz, 10 VA
- 12 VDC

Power consumption:

- Typ 1.5 W with DC-supply (excluding accessories)
- Typ 2.5 W with AC-supply (excluding accessories)

Ambient temperature range: 0 °C to +50 °C

Humidity: max 90 %, non condensing

Case: 9 modules DIN case, 156x85x60 mm, IP21

Weight: 0.3 kg

25 Resistance measurement range

For resistance inputs it is important to verify that the measurement range of the connected sensor matches the range of the device for the expected temperature range. The table below shows the resistance measurement range for the different UltraBase devices.

Measurement range for Ex- and Mx-expansion modules can be found in **Referensmanual IMSE Expansionsmoduler**

Device	Measurement range
UltraBase20	800-1600 Ω ¹
UltraBase30	80-240 Ω ² 200-2400 Ω 2000-24000 Ω 20000-200000 Ω
UltraBase30+	80-240 Ω ² 200-2400 Ω 2000-24000 Ω 20000-249000 Ω
UltraBase40	800-1580 Ω ¹

¹ For Pt1000 sensors this corresponds to approximately -50 to +150 °C.

² The resistive input has four measurement ranges that can be selected automatically or manually.

25.1 Measurement accuracy UltraBase20

The accuracy is better than 1 Ω between 800 Ω and 1000 Ω , and is limited by a line between 1 Ω at 1000 Ω and 2 Ω at 1600 Ω .

25.2 Measurement accuracy UltraBase30

Accuracy at ambient temperature

Measuring range 80 Ω – 240 Ω

Resistance	-20 till +50 °C	+10 till +30 °C	Comment
80 Ω	< ± 90 m Ω	< ± 70 m Ω	
100 Ω	< ± 125 m Ω	< ± 100 m Ω	~0.25 °C for Pt100
240 Ω	< ± 530 m Ω	< ± 370 m Ω	

Measuring range 200 Ω – 2.4 k Ω

Resistance	-20 till +50 °C	+10 till +30 °C	Comment
200 Ω	< ± 0.6 Ω	< ± 0.6 Ω	
1000 Ω	< ± 1 Ω	< ± 0.76 Ω	~0.25 °C for Pt100
2400 Ω	< ± 3 Ω	< ± 1.5 Ω	

Measuring range 2 k Ω – 24 k Ω

Resistance	-20 till +50 °C	+10 till +30 °C	Comment
2 k Ω	< ± 5 Ω	< ± 5 Ω	
10 k Ω	< ± 12 Ω	< ± 10 Ω	
24 k Ω	< ± 47 Ω	< ± 35 Ω	

Measuring range 20 k Ω – 200 k Ω

Resistance	-20 till +50 °C	+10 till +30 °C	Comment
20 k Ω	< ± 65 Ω	< ± 64 Ω	
100 k Ω	< ± 530 Ω	< ± 520 Ω	
198 k Ω	< ± 2000 Ω	< ± 1970 Ω	

25.3 Measurement accuracy UltraBase30+

Accuracy at ambient temperature

Measuring range 80 Ω – 240 Ω

Resistance	-20 to +50 °C	+10 to +30 °C	Comment
80 Ω	< ± 90 m Ω	< ± 70 m Ω	
100 Ω	< ± 125 m Ω	< ± 100 m Ω	~0.25 °C for Pt100
240 Ω	< ± 530 m Ω	< ± 370 m Ω	

Measuring range 200 Ω – 2.49 k Ω

Resistance	-20 to +50 °C	+10 to +30 °C	Comment
200 Ω	< ± 0.6 Ω	< ± 0.6 Ω	
1000 Ω	< ± 1 Ω	< ± 0.76 Ω	~0.2 °C for Pt100
2400 Ω	< ± 3 Ω	< ± 1.5 Ω	

Measuring range 2 k Ω – 24.9 k Ω

Resistance	-20 to +50 °C	+10 to +30 °C	Comment
2 k Ω	< ± 5 Ω	< ± 5 Ω	
10 k Ω	< ± 12 Ω	< ± 12 Ω	
24 k Ω	< ± 47 Ω	< ± 47 Ω	

Measuring range 20 k Ω – 249 k Ω

Resistance	-20 to +50 °C	+10 to +30 °C	Comment
20 k Ω	< ± 65 Ω	< ± 64 Ω	

Resistance	-20 to +50 °C	+10 to +30 °C	Comment
100 kΩ	< ±530 Ω	< ±520 Ω	
198 kΩ	< ±2000 Ω	< ±1970 Ω	
240 kΩ	< ±2424 Ω	< ±2387 Ω	

25.4 Measurement accuracy UltraBase40

The accuracy is better than 1 Ω between 800 Ω and 1000 Ω, and is limited by a line between 1 Ω at 1000 Ω and 2 Ω at 1580 Ω.

26 Term Definitions

Acknowledgment A confirmation that you have received and noticed an alarm.

Alarm An alarm is always created based on a channel and monitors the channel's value according to set conditions and limits. **A-alarm** has a red indicator and **B-alarm** has a yellow indicator. In addition to these, you can choose to give an alarm a priority from **C-Z** and they have a blue indication.

Alarm groups Manages alarm sendouts and makes it possible to create features for multiple alarms at the same time.

Application Builds the functions in the Ultra. An application contains graphical programming or script and resources such as channels, parameters, curves, all of which are visible in the graphical programming. Overviews and summaries are part of an application. An application can contain other applications, which are subapplications. In the graphical programming, an application is represented as a box with inputs and outputs. You can create an application template, which can be useful if you want to create similar applications.

Application backup A backup with application templates.

Change history A log that gives an overview of the changes made by users. Includes a selection of resources in the Ultra.

Channels Handles all the variable data in the unit. Channels are viewed in overviews and summaries and are logged and monitored by alarms.

Coils This is a type of a Modbus register. One coil is a 1 bit word.

Components Primitive function blocks in the graphical programming. Connect these with other resources in order to create programs. They exist only in the graphical programming and cannot be reached from other parts of the system.

Curves A table that is presented as a configurable curve. Curves are used by controllers to do things like converting an outdoor temperature into a flow temperature.

Events/Errors A type of alarm that is created by the system. It notifies you when something is wrong in the system that may prevent the unit from functioning.

Expansion modules Used to add more inputs and outputs with different features and communicates automatically with the Ultra. You can connect an expansion module and the system will recognize it and its features.

External units Different types of units that an Ultra can exchange information with, as a master. They can be used for more inputs/outputs, meters and more. For example, Modbus and M-bus units can be connected as external units.

File manager Tool that uploads files to the Ultra. There are predefined folders including sensor definitions, communication definitions and backups.

Graphical programming A tool that creates graphical programs. It enables you to build up an entire system with all of its functions based on the inputs and outputs of the unit.

Holiday catalog A file that can be used when working with time schedules with rules **Weekly** to change which day of the week specific dates should be counted as, for example Christmas Day should be counted as a Sunday regardless of which day of the week it falls on.

I/O-channels Software representations of real inputs and outputs, and allows you to set scale factors, offset and conversion functions for sensors and actuators.

Logs Store values from selected channels with set intervals. Logged data can be displayed as a plot or exported as a table.

Messages Created by script and is stored in the alarm history. An example of a message is that the system has changed into summer operation.

Modbus A protocol that is used to communicate between different units. Values are ordered in numbered registers, which can be read and written by a master.

Node tree Contains all the elements in the system arranged in a hierarchical order. If you open an application, you can view what's in it, and further, if you fold out a subapplication, you can view what's in the subapplication.

Overview Provides a quick overview of the plant. You can add present values, alarms and more to this picture. It also allows easy resource editing.

Parameters Store values that are named and set by the user.

Periodic log This is a log that measures with certain intervals (1 second, 2 seconds, 15 seconds, 1 minute, 5 minutes, 15 minutes, 1 hour or 12 hours). These can measure momentary values, mean value, max value, min value or a sum of a certain period.

Register A type of Modbus register; one register is a 16 bits word.

Sensors and actuators Physical units that are connected to inputs and outputs.

Smart log A log that compresses the data that comes in. Second values are converted to minute values and so on. This allows you to store data for a longer period.

Summary A view with selected channels, parameters, alarms, alarm groups, curves, time schedules and databases. Here you can see their values and change their settings.

System backup (full backup) A backup containing all of the system's settings and data logs, including network settings and users.

Time schedules Used to set when something should be active or inactive. You can add rules that can be repeated weekly, monthly, early or with a free adjustable interval. You can also select not to repeat the rule at all or only set for a specific date.

Universal input Inputs that measure different kind of quantities (resistance, current and voltage).