

IMSE **Ultra**

User manual

UltraBase20

UltraBase30

UltraBase40

Valid for release 1.95.X

2023-11-20

Contents

- 1 Introduction 5**
 - 1.1 Other Manuals 6
 - 1.2 Warranty 6

- 2 Overview of the device 8**
 - 2.1 Menus 9
 - 2.2 Menus limited view 11
 - 2.3 Connect a PC directly to IMSE UltraBase 12

- 3 Overviews 13**
 - 3.1 How To Use 13

- 4 Summaries 15**
 - 4.1 Channels 15
 - 4.2 Parameters 16
 - 4.3 Alarms 16
 - 4.4 Time schedules 17
 - 4.4.1 Date 18
 - 4.4.2 Weekly 19
 - 4.4.3 Monthly 20
 - 4.4.4 Yearly 20
 - 4.4.5 Periodically 22
 - 4.5 Curves 22

- 5 Alarms 24**
 - 5.1 Active Alarm 24
 - 5.2 Alarm History 25
 - 5.3 Alarm Types 25
 - 5.4 Alarm List 27
 - 5.5 Alarm Groups 27
 - 5.6 Alarm Sendouts 29

- 6 Logging data 32**
 - 6.1 Types of logs 32
 - 6.2 Create logs 34
 - 6.3 View logs 34
 - 6.3.1 Add a log to a plot 35

6.3.2	Selection of time period	36
6.3.3	Logs	36
6.4	Zoom and pan	37
6.4.1	Zoom with mouse wheel	37
6.4.2	Zoom with selection	37
6.4.3	Pinch zoom (only works with touch screen)	37
6.4.4	Reset zoom	37
6.4.5	Pan	37
6.5	Tooltip	37
6.6	Saved views	38
6.6.1	Create saved view	38
6.6.2	Delete saved view	38
6.6.3	Modify saved view	38
6.6.4	Export data	38
6.7	Log sendouts	38
7	Communication	42
7.1	Network	42
7.2	Mail Host	43
7.3	Recipients	44
7.4	Modbus Slave Register	44
7.5	Modbus Slave Settings	45
7.6	Modbus TCP Gateway	45
7.7	RS485 Ex settings	45
7.8	External devices sendouts	45
7.9	Portal Update	45
7.10	Companion	46
7.10.1	Showing alarms	47
7.10.2	Home, overviews and summary pages	47
8	System	49
8.1	Notes	49
8.2	File Manager	50
8.3	Users	51
8.4	Settings	53
8.5	Backups	54
8.5.1	Create a new application backup	56
8.5.2	Create a new system backup	56

8.5.3	Create an automatic system backup to SD card	56
8.5.4	Front panel buttons for SD-card on UltraBase30	57
8.6	Update	58
8.7	Operator panel	59
8.8	Information	59
8.9	Change history	59
9	Help	60
9.1	Manual	60
9.2	Support	60
10	The unit UltraBase20	61
10.1	Power supply	62
11	The unit UltraBase30	63
11.1	Power Supply	64
12	The unit UltraBase40	65
12.1	Power supply	66
13	Term Definitions	67

All information in this manual is based on information available at the time of printing. The manual is published to ease the use of an Ultra. Abelko Innovation cannot guarantee that there are no mistakes or errors in this documentation and cannot be held responsible for any consequences resulting from the use or misuse based on this information.

All information in this document can be changed without notice. It is likely that certain sections will be change at the release of new product versions. Be sure to have the latest version of this document and the corresponding version of Ultra.

© Abelko Innovation. All Rights Reserved.

1 Introduction

Welcome to IMSE Ultra. This series of products consists of the control units IMSE UltraBase20, IMSE UltraBase30 and IMSE UltraBase40, operator panel IMSE Ultra OP and expansion modules that can be connected to expand the number of inputs and outputs.

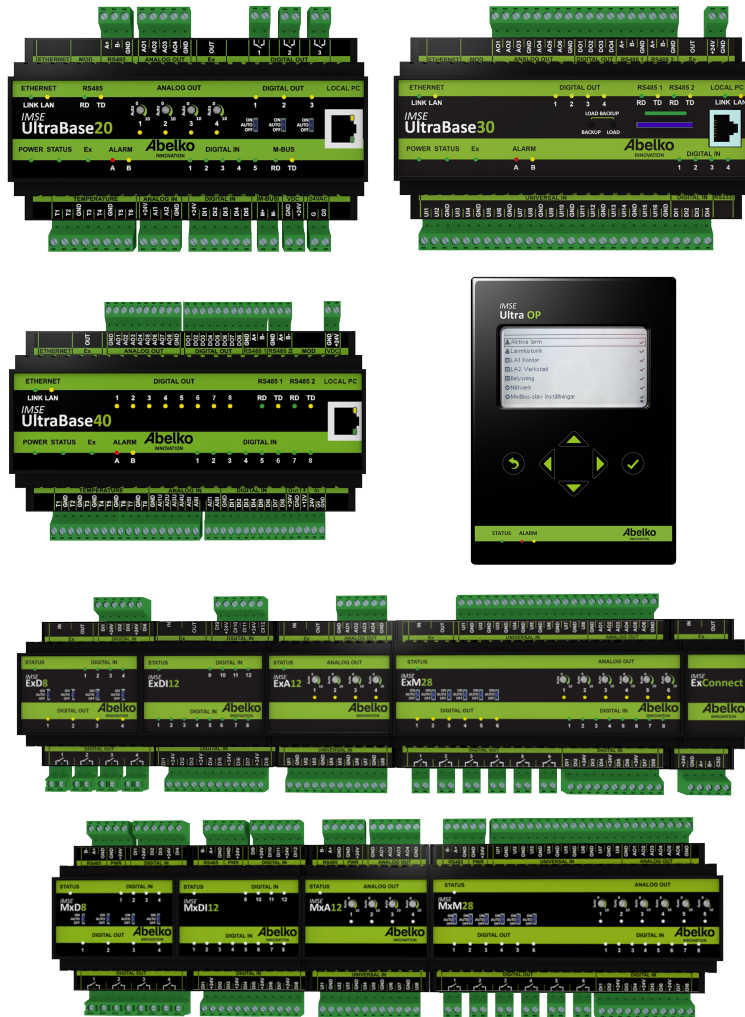

This user manual is mainly for the person using the pre-configured system. It aims to provide a guide on how to use the system in the easiest and most effective way.

1.1 Other Manuals

Configuration manual: information on how to configure the system.

Reference manual: more detailed technical information and script programming.

Quick start guide: information on how to quickly get the system up and running.

All manuals are available for download at www.abelko.se

1.2 Warranty

1. Abelko will repair any design, material and manufacturing defects at its own expense, provided they occur during normal use and the purchaser submits a claim within 60 months of the verified delivery date. The purchaser is responsible for removal, re-installation and for paying transport costs to Abelko, and Abelko will repair the defect and return the equipment free of charge to the purchaser.
2. The warranty only covers design, material and manufacturing defects. Abelko is not responsible for defects caused by a failure to follow the instructions, or defects resulting from normal wear and tear, poor maintenance, unauthorized work, noncompliant operating conditions, incorrect installation or repairs not carried out by Abelko or an authorized agent, voltage surges or other electrical faults.
3. Abelko's responsibility for defects is limited to the circumstances described above. Abelko is not responsible for any consequential damage that may occur as a result of design, material and manufacturing defects. The purchaser is therefore not entitled to use defects as grounds for compensation or any other claim, except in the circumstances described above, nor may such claim be made against any third parties responsible for fulfilling this warranty.
4. Abelko is not responsible for restoring any configurations, etc. added by the purchaser. The purchaser should create a backup of configurations and save them to a server.

The information in this document is the property of Abelko Innovation. The content is confidential and unless you have Abelko Innovation's written permission, you may not disclose it to anyone except Abelko Innovation personnel, resellers, agents or licensees. You may not copy parts of the document or save it to data media or other media, including photocopying or recording, unless you have the permission of the copyright holder, Abelko Innovation.

Abelko Innovation makes no guarantees in respect of the content of this document. Abelko Innovation also retains the right to alter, add or remove parts of the document at any time and without notice. Reasons for doing so include printing errors, incorrect information and software/product improvements. Any such changes will always be included in new editions of this document.

All rights reserved.

2 Overview of the device

IMSE UltraBase is a general device for controlling and monitoring buildings, systems or facilities. It is configured to do a certain task and connects to sensors, actuators and other devices. This manual requires that the device is configured and installed in a facility.

The device's user interface is web-based, which means that the device is available through a web browser. As a complement you have **IMSE Ultra OP**, a text-based operator panel that can be connected to a control unit locally.

When browsing the device's URL or IP number, you will see a login window. The person who configures the device sets up users and passwords and gives the user a user level. You can also select which language you want to use. The device has been tested to work with the latest versions of Firefox and Chrome.

Factory default the system has following users:

User name	Password	User level
view	ab12	View
operator	cd34	Operator
config	ef56	Configurator

They should be deleted or have changed passwords before connecting the device to the Internet.

For each user, there is the possibility to set automatic logout when the user has been inactive. This setting is found under **Users**

The user level **View** allows the user to view the user interface, but not to change anything. An **Operator** may change settings and is intended for those who will take care of the facility. A **Configurator** has full rights, can configure the whole device, upgrade the software, restore backups, and more.

Warnings when logging in!

The first time you log in to an Ultra, you will be warned that the connection is not private, or similar. This is because the **HTTPS** that is being used in the system is a secure and encrypted connection. The security is guaranteed by a certificate, which needs to be issued for a specific IP number. Since the IP address is adjustable, there is no certificate for the unit. **You need to add this exception.** The procedure differs depending on which browser you are currently using.

When you log in you will come to a homepage. The start page can consist of an overview or a summary created by the person who configured the system. The purpose is that you quickly can read values

of interest or make settings using these overviews and summaries. If there are no overviews or summaries, the list of active alarms will appear on the homepage. Under the menu **System** and **Settings** you can choose what you want to see at the homepage.

There are four buttons up in the interface:



The bell indicates if there are any active alarms in the system, the icon with multiple bells indicates if there are any active alarms for any companions and the letter shows if there are any new notes. The hand indicates that there are manually overridden channels, and is only shown if there are. By clicking on these, you will be directed to more detailed information.

On the left side there is (usually) a node tree with more overviews and summaries. Click in it in order to change overview or summary.

2.1 Menus



Home

- Home page with a list over summaries and overviews



Alarm

- Active alarms
- Alarm history

-
- Alarm list
 - Alarm groups
 - Alarm sendouts



Data

- Data logs
- Log sendouts



Communication

- Network

- **Email**
- **Recipients**

- **Modbus slave register**
- **Modbus slave settings**
- **Modbus TCP Gateway**

- **RS485 Ex settings**

- **External units sendouts**
- **Portal update**
- **Companion**



Configuration

- **Graphical programming**
- **Summaries**
- **Overviews**

- **In- & outputs**
- **External units**
- **Web shares**

- **Applications & resources**



System

- **Notes**
- **File manager**
- **Users**
- **Settings**
- **Backups**
- **Update**

- **Operator panel**

- **Information**

- **Change history**



Help

- **Manuals**
- **Support**

2.2 Menus limited view

A user can have limited view of the web pages, which means that not all menus are visible.

To temporarily leave this mode, go to the menu **Help** and **Support**. Under **Limited view**, you can enable/disable the limited view temporarily by using the check box, and then click **Set**. Now you will be able to see the menus until the pages are updated or until you log out.

The following menus are visible during **limited view**:



Home

- Home page with a list over summaries and overviews



Alarm

- **Active alarms**
- **Alarm history**



Data

- **Data logs**



System

- **Notes**
- **Information**



Help

- **Manuals**
- **Support**

2.3 Connect a PC directly to IMSE UltraBase

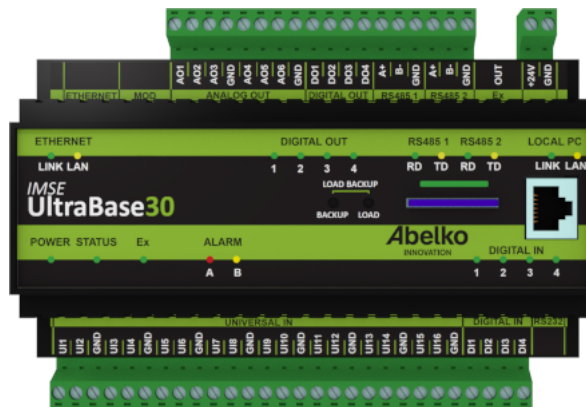

If your Ultra is not connected to a network you have access to, you can connect a computer directly to the Ultra. On the front, to the right, there is an Ethernet port labelled **LOCAL PC**. It can be used to connect a network cable directly to your computer. You can then go to the address **https:\192.168.142.1**.

The **LOCAL PC** port has a DHCP server. It automatically provides a connected PC network setting so that you can access the web pages directly without manually changing settings. **This means that you should never connect this port to a network.**

The port is slower than the one labelled **ETHERNET** and should only be used to configure the regular network connection.

The Ethernet port for regular network connection is on the top left. There are two LEDs for the port. **LINK** shines yellow when the Ultra is connected to a network and **LAN** flashes green when there is communication on the network.

On the front of an UltraBase30 there is place for a SD card. See chapters **Updates** and **Backup on SD-card** for more information on how to use this.

3 Overviews

Overviews are pictures created of an installation with important values so you can quickly and easily see the status of the installation.

This chapter will explain how overviews work and how they can be used.

3.1 How To Use

An overview provides a schematic image of a system since it can be customized to how your installation looks like.

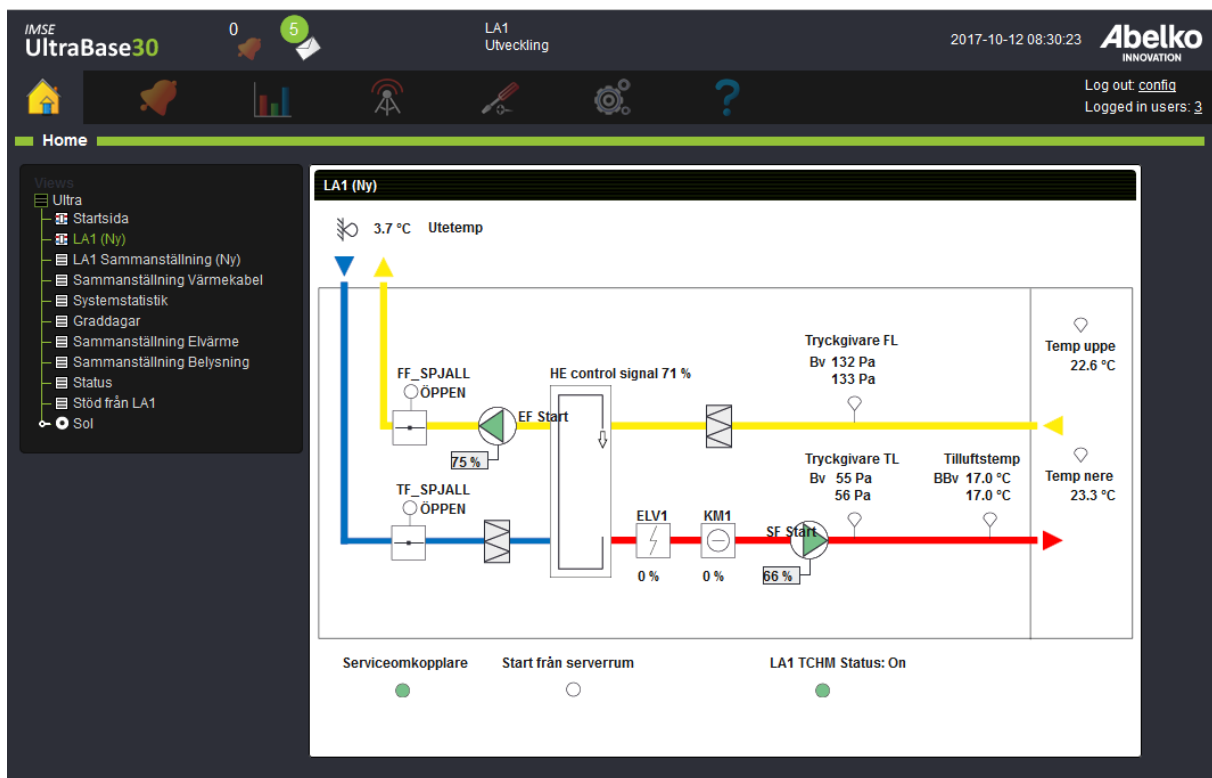

An overview is created with the overview tool (located under the menu **Configuration, Overviews**). The overview consists of values, symbols and graphs which show current values (updated every 3rd second).

Values have different view alternatives. They can be viewed as an animated image or as an image who change it appearance when a resource reaches a certain value. For example, an active alarm can change the color of a channel value.

Click on a resource to change settings, see alarm limits and more depending on resource type.

If you want to change the **start page** go to the menu **System, Settings**.

The screenshot displays the configuration interface for the IMSE UltraBase30 system. The top navigation bar includes the system name, status indicators (0), the current date and time (2018-12-06 12:29:56), and the Abelko logo. A secondary bar contains icons for home, notifications, charts, antenna, tools, settings, and help. The main content area is titled 'Settings' and contains several panels:

- Settings**: Fields for 'Module name' and 'Module address', with a 'Save' button.
- Choose start page**: Radio buttons for 'Overview', 'Summary' (selected), and 'Active alarms'. A 'Name' dropdown is set to 'LA71'. Below, there are checkboxes for 'Show on startpage:' (with an 'Edit' button) and 'Expand companion trees.', along with a 'Save' button.
- Set time**: Fields for 'Date' (2018-12-06) and 'Time' (12:29:37). A checked 'Activate NTP' checkbox is followed by an 'NTP server' field containing 'ntp1.sptime.se' and a 'Save' button.
- Other settings**: A 'Tag separator' field containing a hyphen '-' and a 'Save' button.
- Reboot**: A text box stating 'The system will be rebooted and you will be able to login again after the reboot has been completed.' and a 'Reboot' button.

4 Summaries

Summaries are menu pages with added resources to see and edit, such as channels, parameters, alarms and more. Summaries are created by the person who configured the system.

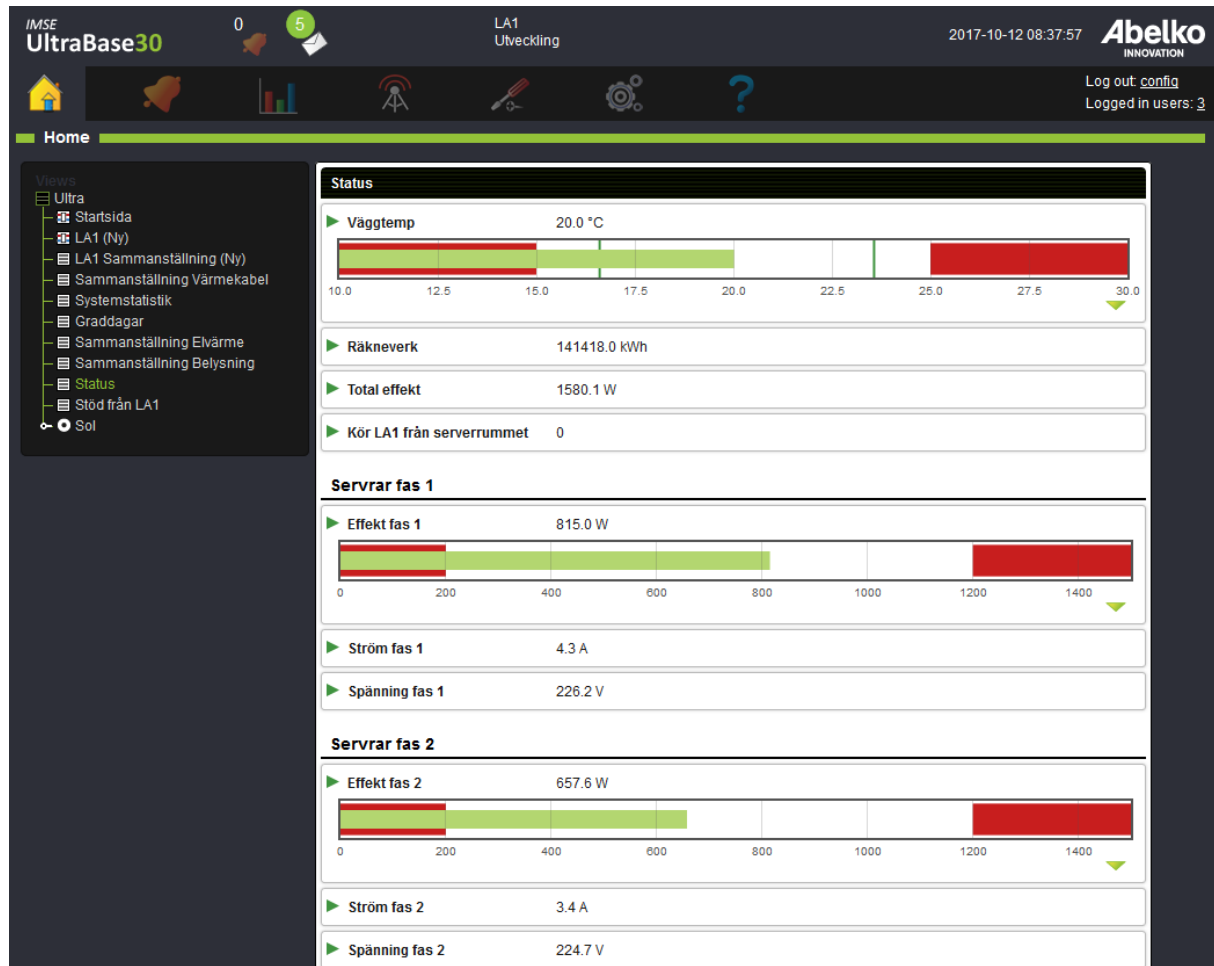

This chapter will explain how the different resources look like in a summary and how they work.

4.1 Channels

Channels handle all the variable data in the unit and have different view alternatives. They can be viewed as a row with name and value, as a graph or as a table. Channels are used for logs and alarm.

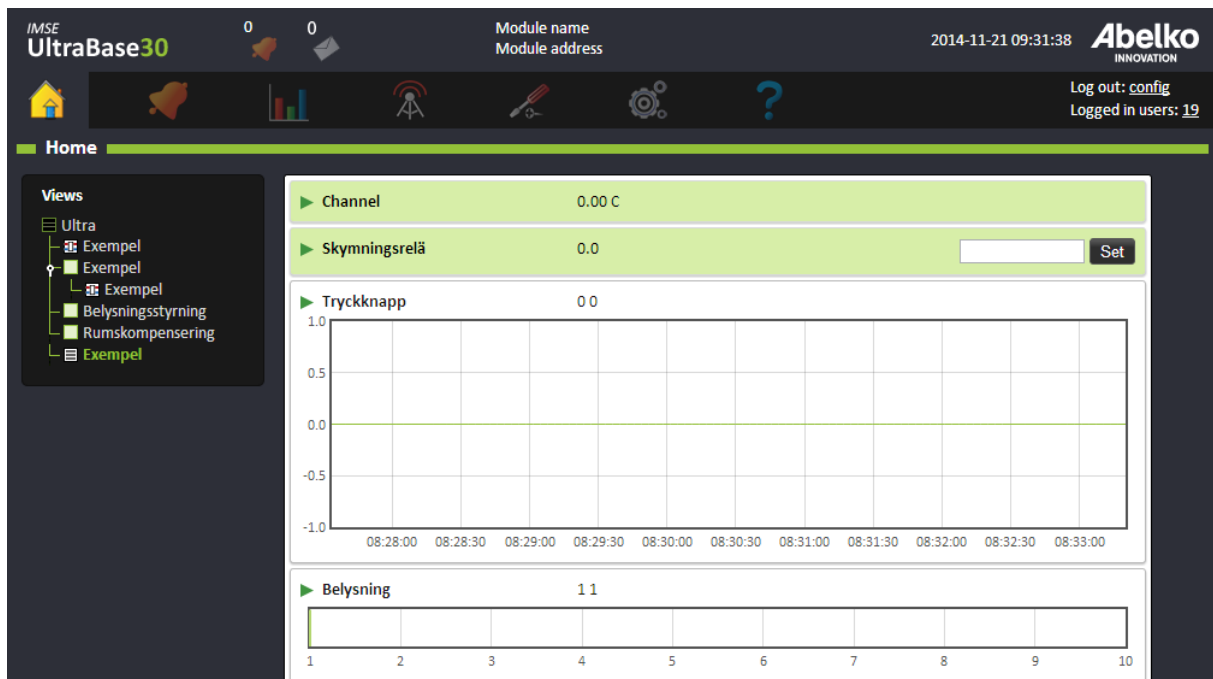

4.2 Parameters

Parameters are used to store settings and can be both editable and non-editable. If they are editable you can set their values.

<input checked="" type="radio"/> Funktionsval	Manuellt till	Avstä ▾	Set
<input checked="" type="radio"/> Tryckknappstid	10.0 Minuter	<input type="text"/>	Set

4.3 Alarms

Alarms will help you monitor channel values. You can see its name and current status. If the alarm is active, click on it to go to the active alarm list where you can acknowledge it if needed.

 Exempel 0

4.4 Time schedules

A **time schedule** is used to set times when things should be active or inactive.



Edit will take you to the timeschedule's settings.

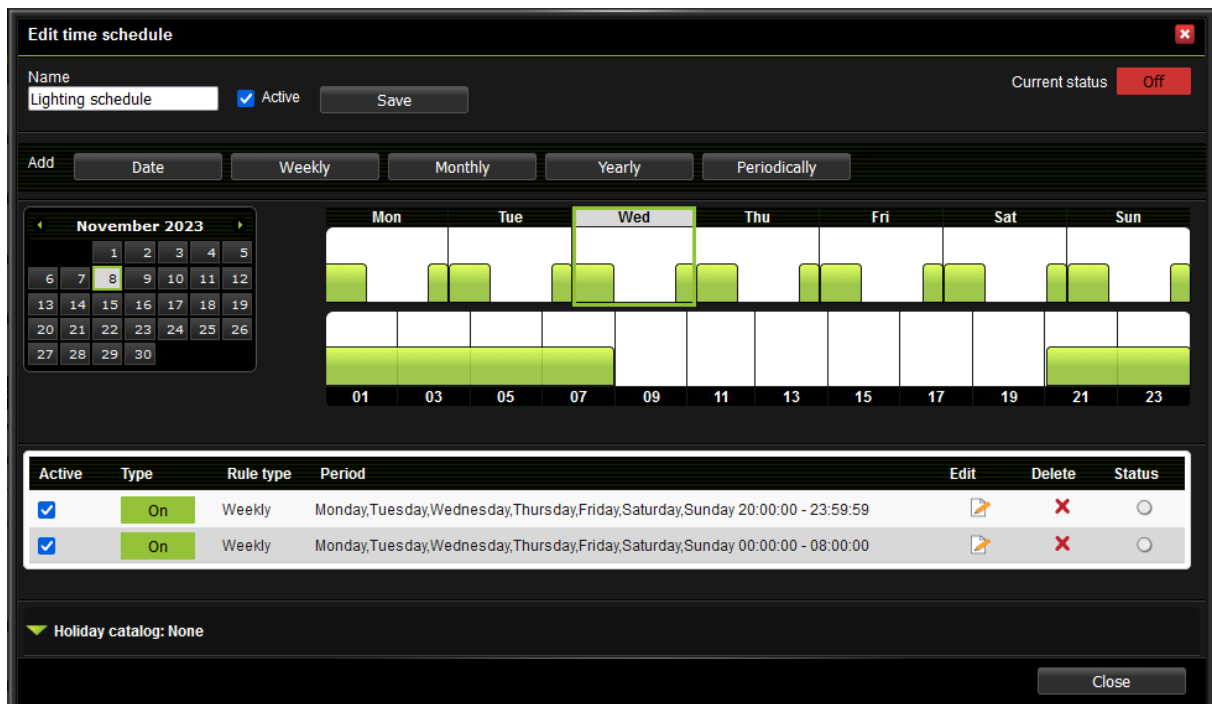

The 'Edit time schedule' window shows the following details:

- Name: Lighting schedule
- Active:
- Current status: Off
- Frequency: Weekly
- Calendar: November 2023
- Weekly view: Shows green blocks for Monday, Tuesday, Wednesday, Thursday, Friday, Saturday, and Sunday.
- Rules table:

Active	Type	Rule type	Period	Edit	Delete	Status
<input checked="" type="checkbox"/>	On	Weekly	Monday,Tuesday,Wednesday,Thursday,Friday,Saturday,Sunday 20:00:00 - 23:59:59			<input type="radio"/>
<input checked="" type="checkbox"/>	On	Weekly	Monday,Tuesday,Wednesday,Thursday,Friday,Saturday,Sunday 00:00:00 - 08:00:00			<input type="radio"/>

Holiday catalog: None

Close

You can see the time schedule's **current status** on the top of the page. To **disable** a schedule uncheck the box to the left of its name. The time schedule will not become active until you select the box again.

The calendar to the left has current date highlighted. Click on a date to see that day's details and also details for that week. You can also click on the week view to change which day you will see details for. Green blocks enables (activates) the resource and red blocks disables (inactivates) the resource. **The red blocks always rule over the green blocks.**

The list at the bottom is an overview for all added rules in the timeschedule. The rule's current **status** is located to the right.

- If the rule **enables** objects and is currently **active**, the light shines **green**.
- If the rule **disables** objects and is currently **active**, the light shines **red**.
- If the rule is **not active**, it will be **grey** regardless if it enables or disables objects.

You can delete a rule or disable it with the box under **Type**.

Under **Holiday catalog** you can choose to activate a holiday catalog which is uploaded via the **System > File Manager** page under the folder **Holiday catalogs**. You can see which dates the file contains along with a description and which day of the week the date will be counted as. This can be used if, for example, you have a regulation that the heat should be lowered on Sundays since the premises are not being used at that time, but that this should also apply to public holidays such as Christmas Eve that occurs on a weekday.

Add a new rule by clicking on a rule type: **Date, Weekly, Monthly, Yearly** or **Periodically**.

4.4.1 Date

This is used when you want to do something on a specific date.

The screenshot shows a configuration window titled "Date". At the top left, there are two buttons: "On" (highlighted in green) and "Off". At the top right, there is an "Active" checkbox which is checked. Below this, there are two main sections: "Start" and "Stop". Each section contains a text input for "YYYY-MM-DD" and "TT:MM:SS" with a dropdown arrow. The "Start" section has "2014-11-20" and "07:42:00". The "Stop" section has "2014-11-21" and "07:42:00". Below each text input is a calendar for "November 2014". The "Start" calendar has the 20th highlighted in green. The "Stop" calendar has the 20th and 21st highlighted in green. At the bottom right, there are "Cancel" and "Save" buttons.

1. Select if you want the rule to enable (**On**) or disable (**Off**) objects.
2. Set start and stop time in the boxes **YYYY-MM-DD** and **TT:MM:SS**.
3. Mark the date in the calendar.

The rule will automatically be set to **Active**. You can **Inactivate** it by using the checkbox up in the corner. If you click **Cancel**, you will leave you the page without saving the changes you have made.

4. Click **Save**. The rule will now be included in the list on the overview page.

4.4.2 Weekly

This is used when you want something to be repeated every week.

1. Select if you want the rule to enable (**On**) or disable (**Off**) objects.

The screenshot shows a configuration window titled "Weekly". At the top left, there are two buttons: "On" (highlighted in green) and "Off" (grey). In the top right corner, there is a checkbox labeled "Active" which is checked. Below this is a "Start - Stop" section with two time input fields, both containing "00:00:00". Underneath the time fields is a horizontal bar chart representing a 24-hour cycle, with the first hour (00) highlighted in green. Below the bar chart is a "Weekdays" section with seven checkboxes for Monday through Sunday, all currently unchecked. At the bottom right, there are two buttons: "Cancel" and "Save".

2. Set start and stop time by moving the bar in the time axis or type the time in the boxes.
3. Select the days the rule should apply to by clicking on the weekdays.

The rule will automatically be set to **Active**. You can **Inactivate** it by using the checkbox up in the corner. If you click **Cancel**, you will leave you the page without saving the changes you have made.

4. Click **Save**. The rule will now be included in the list on the overview page.

4.4.3 Monthly

This is used when you want something to be repeated every month.

1. Select if you want the rule to enable (**On**) or disable (**Off**) objects.

The screenshot shows a configuration window titled "Monthly". At the top left, there are two buttons: "On" (highlighted in green) and "Off". At the top right, there is a checkbox labeled "Active" which is checked. Below these are two sections for time configuration. The first section is labeled "Start" and has a text input field containing "00:00:00" and a time axis bar with labels from 00 to 24. A green slider is positioned at the 24 mark. The second section is labeled "Stop" and has a text input field containing "00:00:00" and a similar time axis bar with a green slider at the 00 mark. To the left of the time axes is a calendar grid labeled "Days" with numbers 1 through 31. At the bottom of the window are two buttons: "Cancel" and "Save".

2. Set start and stop time by moving the bar in the time axis or type the time in the boxes.
3. Mark the date in the calendar.

The rule will automatically be set to **Active**. You can **Inactivate** it by using the checkbox up in the corner. If you click **Cancel**, you will leave you the page without saving the changes you have made.

4. Click **Save**. The rule will now be included in the list on the overview page.

4.4.4 Yearly

This is used when you want something to be repeated yearly.

Yearly

Active

Start

00:00:00

00 01 02 03 04 05 06 07 08 09 10 11 12 13 14 15 16 17 18 19 20 21 22 23

January							February							March							April						
1	2	3	4	5	6	7	1	2	3	4	5	6	7	1	2	3	4	5	6	7	1	2	3	4	5	6	7
8	9	10	11	12	13	14	8	9	10	11	12	13	14	8	9	10	11	12	13	14	8	9	10	11	12	13	14
15	16	17	18	19	20	21	15	16	17	18	19	20	21	15	16	17	18	19	20	21	15	16	17	18	19	20	21
22	23	24	25	26	27	28	22	23	24	25	26	27	28	22	23	24	25	26	27	28	22	23	24	25	26	27	28
29	30	31					29							29	30	31					29	30					

May							June							July							August						
1	2	3	4	5	6	7	1	2	3	4	5	6	7	1	2	3	4	5	6	7	1	2	3	4	5	6	7
8	9	10	11	12	13	14	8	9	10	11	12	13	14	8	9	10	11	12	13	14	8	9	10	11	12	13	14
15	16	17	18	19	20	21	15	16	17	18	19	20	21	15	16	17	18	19	20	21	15	16	17	18	19	20	21
22	23	24	25	26	27	28	22	23	24	25	26	27	28	22	23	24	25	26	27	28	22	23	24	25	26	27	28
29	30	31					29	30						29	30	31					29	30	31				

September							October							November							December						
1	2	3	4	5	6	7	1	2	3	4	5	6	7	1	2	3	4	5	6	7	1	2	3	4	5	6	7
8	9	10	11	12	13	14	8	9	10	11	12	13	14	8	9	10	11	12	13	14	8	9	10	11	12	13	14
15	16	17	18	19	20	21	15	16	17	18	19	20	21	15	16	17	18	19	20	21	15	16	17	18	19	20	21
22	23	24	25	26	27	28	22	23	24	25	26	27	28	22	23	24	25	26	27	28	22	23	24	25	26	27	28
29	30						29	30	31					29	30						29	30	31				

Stop

00:00:00

00 01 02 03 04 05 06 07 08 09 10 11 12 13 14 15 16 17 18 19 20 21 22 23

1. Select if you want the rule to enable (**On**) or disable (**Off**) object.
2. Set start and stop time by moving the bar in the time axis or type the time in the boxes.
3. Mark the date in the calendar.

The rule will automatically be set to **Active**. You can **Inactivate** it by using the checkbox up in the corner. If you click **Cancel**, you will leave you the page without saving the changes you have made.

4. Click **Save**. The rule will now be included in the list on the overview page.

4.4.5 Periodically

This is used when you want something to be repeated a certain period.

Periodically

On Off Active

Period time *Every each* Duration

Day Hour Minute Second Day Hour Minute Second

Delay

Day Hour Minute Second

0 0 0 0

Cancel Save

1. Select if you want the rule to enable (**On**) or disable (**Off**) objects.
2. Set **Period time**, this will decide how often the period should be repeated. For example, if you want something to be repeated every third day, type **3** under Day.
3. Set for how long you want it to be active under **Duration**. For example, two hours by typing 2 under **Hours**.
4. You can also add a **Delay**. This gives a delay into the period when the duration will be active. For example, five hours by typing 5 under **Hours**.

This means that it will be active every third day during 05:00 and 07:00.

The rule will automatically be set to **Active**. You can **Inactivate** it by using the checkbox up in the corner. If you click **Cancel**, you will leave you the page without saving the changes you have made.

5. Click **Save**. The rule will now be included in the list on the overview page.

4.5 Curves

A **curve** is a interpolation table presented as an configurable curve. Curves are used to do things like converting an outdoor temperature into a flow temperature and can be monitored by the user both graphically and numerically.

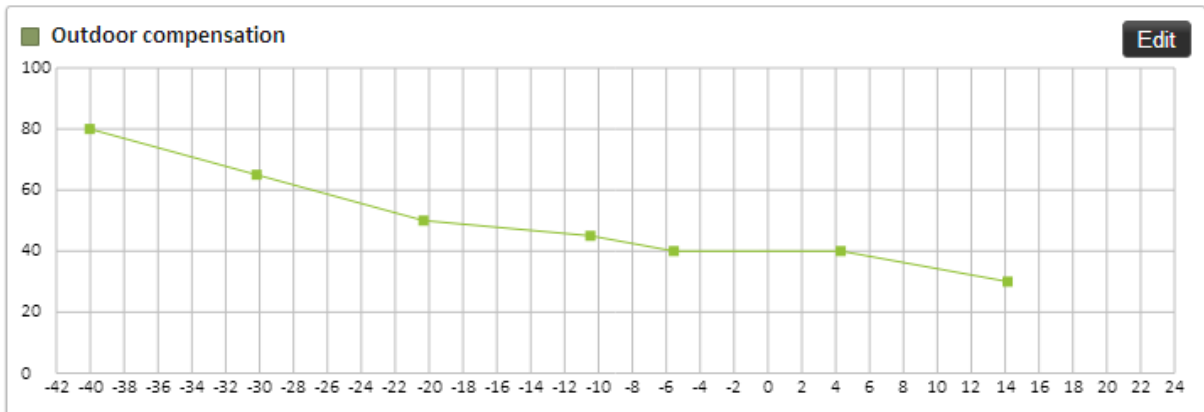

In this example you can see how the outdoor temperature (x-axis) affects the set value for the flow temperature (y-axis). For example, you can see that when the outdoor temperature reaches 0 °C, the flow temperature should be 40 °C.

Click **Edit** to change settings. You can edit the curve directly in the graph or use the table under the graph. Add a new data point by double-clicking in the graph. A double-click on a data point will erase it.

5 Alarms

This chapter will explain how alarms and alarm history are viewed. It will also explain the different types of alarms, how to acknowledge alarms and how to change the settings for alarm sendouts.

5.1 Active Alarm

All active alarms in the system are listed on **Active alarms**.

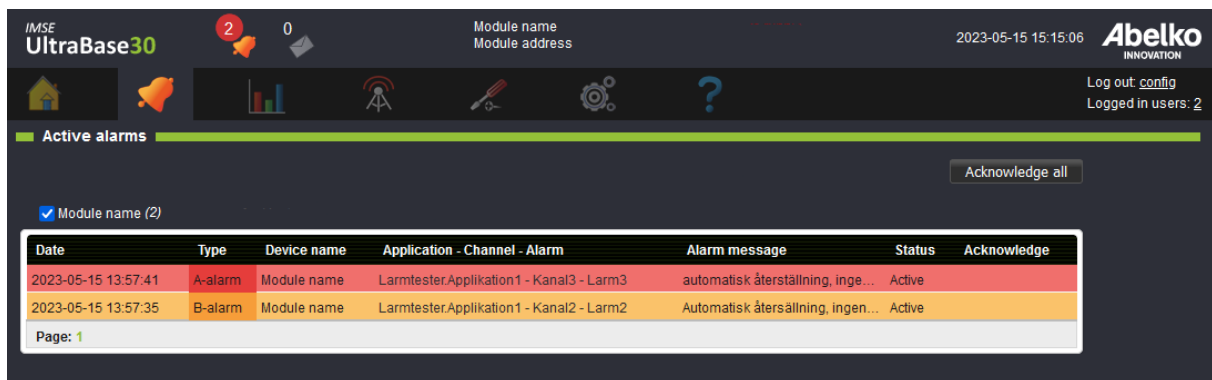

The screenshot shows the IMSE UltraBase30 web interface. At the top, there is a navigation bar with the logo, a notification bell icon with a red '2', and a mail icon with a '0'. The date and time are 2023-05-15 15:15:06. The user is logged in as 'config' with 2 other users. Below the navigation bar, there is a section titled 'Active alarms' with a green bar. A table lists the active alarms:

Date	Type	Device name	Application - Channel - Alarm	Alarm message	Status	Acknowledge
2023-05-15 13:57:41	A-alarm	Module name	Larmtester.Applikation1 - Kanal3 - Larm3	automatisk återställning, inge...	Active	
2023-05-15 13:57:35	B-alarm	Module name	Larmtester.Applikation1 - Kanal2 - Larm2	Automatisk återsällning, ingen...	Active	

Below the table, there is a 'Page: 1' indicator and an 'Acknowledge all' button.

Click **Acknowledge** to acknowledge an alarm with your name. You can also **Acknowledge all** the alarms. Click on an alarm to get more detailed information about the alarm.

An alarm stops being active when it has been inactivated and/or acknowledged, depending on the alarms settings. You can see the alarm event on the page **Alarm history**.

The number of active alarms will also be indicated on the top of the web interface.



When it has a red symbol, it means that at least one of the active alarms is an **A-alarm**. When it has a yellow symbol, at least one of the active alarms is an **B-alarm**, and a blue symbol is when the alarms are **C-Z alarms**. If the symbol is blinking, it means that there are alarms that need to be acknowledged.

If the device has one or more companions, the table is extended with another column stating which device the alarm belongs to.

5.2 Alarm History

Here, all the alarm events are listed. You can see when they were activated, inactivated and acknowledged.

A-alarms are red, B-alarms are yellow and C-Z alarms are blue. When an alarm is inactivated, it will turn green.

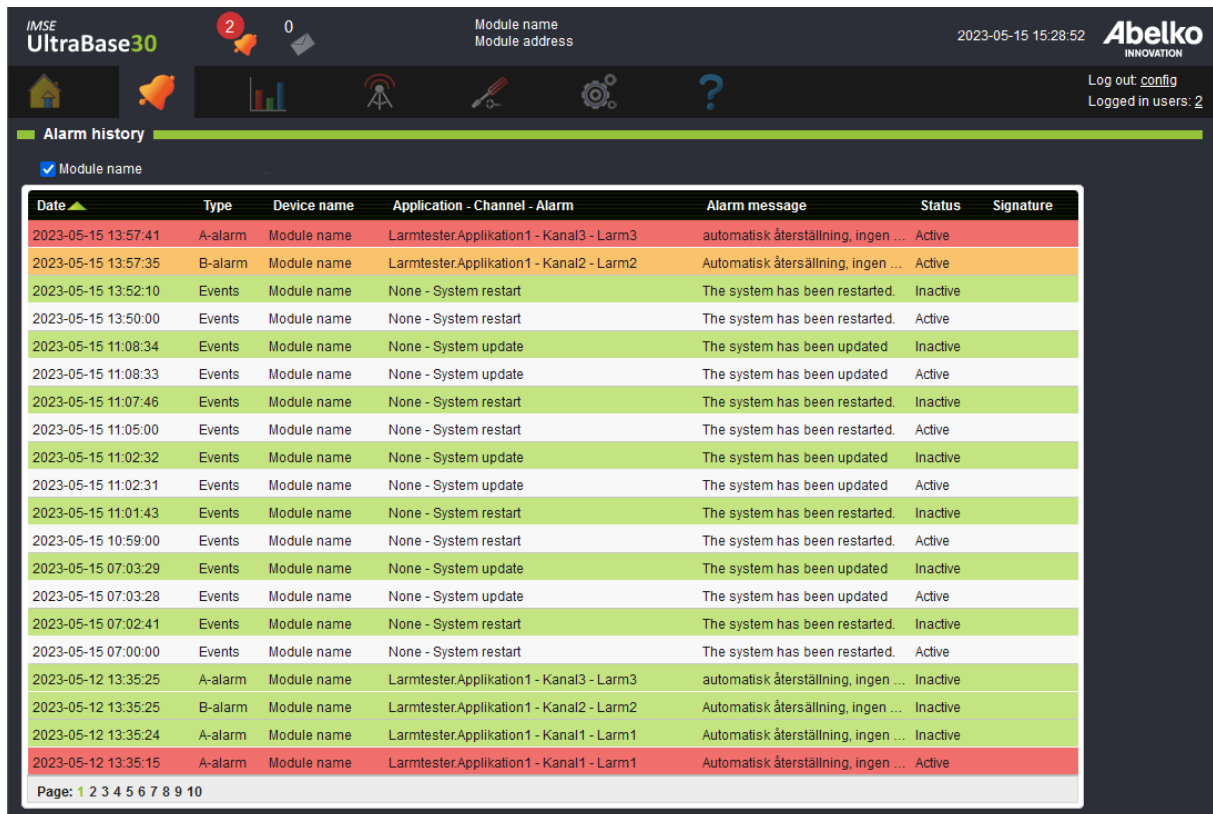

The screenshot displays the 'Alarm history' section of the IMSE UltraBase30 interface. The top navigation bar includes the logo, a notification bell with '2' alerts, a mail icon with '0' messages, and the current date and time '2023-05-15 15:28:52'. Below the navigation bar, there are icons for home, alarm, status, settings, and help. The main content area shows a table of alarm events with the following columns: Date, Type, Device name, Application - Channel - Alarm, Alarm message, Status, and Signature. The table lists various events including A-alarms, B-alarms, and Events, with their respective dates, times, and statuses. The page number 'Page: 1 2 3 4 5 6 7 8 9 10' is visible at the bottom of the table.

Date	Type	Device name	Application - Channel - Alarm	Alarm message	Status	Signature
2023-05-15 13:57:41	A-alarm	Module name	LarmtesterApplikation1 - Kanal3 - Larm3	automatisk återställning, ingen ...	Active	
2023-05-15 13:57:35	B-alarm	Module name	LarmtesterApplikation1 - Kanal2 - Larm2	Automatisk återställning, ingen ...	Active	
2023-05-15 13:52:10	Events	Module name	None - System restart	The system has been restarted.	Inactive	
2023-05-15 13:50:00	Events	Module name	None - System restart	The system has been restarted.	Active	
2023-05-15 11:08:34	Events	Module name	None - System update	The system has been updated.	Inactive	
2023-05-15 11:08:33	Events	Module name	None - System update	The system has been updated.	Active	
2023-05-15 11:07:46	Events	Module name	None - System restart	The system has been restarted.	Inactive	
2023-05-15 11:05:00	Events	Module name	None - System restart	The system has been restarted.	Active	
2023-05-15 11:02:32	Events	Module name	None - System update	The system has been updated.	Inactive	
2023-05-15 11:02:31	Events	Module name	None - System update	The system has been updated.	Active	
2023-05-15 11:01:43	Events	Module name	None - System restart	The system has been restarted.	Inactive	
2023-05-15 10:59:00	Events	Module name	None - System restart	The system has been restarted.	Active	
2023-05-15 07:03:29	Events	Module name	None - System update	The system has been updated.	Inactive	
2023-05-15 07:03:28	Events	Module name	None - System update	The system has been updated.	Active	
2023-05-15 07:02:41	Events	Module name	None - System restart	The system has been restarted.	Inactive	
2023-05-15 07:00:00	Events	Module name	None - System restart	The system has been restarted.	Active	
2023-05-12 13:35:25	A-alarm	Module name	LarmtesterApplikation1 - Kanal3 - Larm3	automatisk återställning, ingen ...	Inactive	
2023-05-12 13:35:25	B-alarm	Module name	LarmtesterApplikation1 - Kanal2 - Larm2	Automatisk återställning, ingen ...	Inactive	
2023-05-12 13:35:24	A-alarm	Module name	LarmtesterApplikation1 - Kanal1 - Larm1	Automatisk återställning, ingen ...	Inactive	
2023-05-12 13:35:15	A-alarm	Module name	LarmtesterApplikation1 - Kanal1 - Larm1	Automatisk återställning, ingen ...	Active	

Click on an alarm to get more detailed information about the alarm.

5.3 Alarm Types

An **alarm** is created based on a channel in the graphical programming and can have different types of priorities.

The different **priorities** are:

- **A-alarm** (red indication)

- **B-alarm** (yellow indication)
- In addition to these, an alarm can have the priority **C-Z** (blue indicator)

In addition to these types, there are **events/errors** and **messages**. **Events/errors** are created by the system and provide information when there is an error in the system, preventing from working properly.

Messages are created by script and provide information concerning system changes, such as the system being switched over to summer mode

The different **conditions** are:

- **Equals (value = limit 1)**: the alarm is activated when the value is exactly the same as the value entered under Limit 1.
- **Greater than (value > limit 1)**: the alarm is activated when the value is greater than the value entered under Limit 1.
- **Less than (value < limit 1)**: the alarm is activated when the value is less than the value entered under Limit 1.
- **Greater (abs (value) > limit 1)**: the alarm is activated when the value is greater than the value entered under Limit 1 without taking into account whether the value is positive or negative.
- **Smaller (abs (value) < limit 1)**: the alarm is activated when the value is smaller than the value entered under Limit 1 without taking into account whether the value is positive or negative.
- **Between (limit 1 < value < limit 2)**: the alarm is activated when the value is between the values entered under Limit 1 and Limit 2.
- **Outside (limit 1 > value > limit 2)**: the alarm is activated when the value is below the value entered under limit 1 or above the value under Limit 2.

The **Hysteresis** settings prevent the alarm from repeatedly switching between active and inactive when the value is equal to the limit. It specifies the number of degrees by which the value must fall back below the limit or limits before the alarm can be cleared.

The **On-filter** specifies the number of consecutive seconds the alarm condition must be true before the alarm is triggered. The **Off-filter** specifies the number of consecutive seconds the alarm condition must be false before the alarm is cleared.

The different **acknowledgments** are:

- **Reset when acknowledged**: the alarm remains active until a user acknowledges it. If the error remains after the alarm is acknowledged, it will remain active until the error is cleared, including the delay and hysteresis.
- **Automatic reset, with acknowledgment**: the alarm reset itself when the error is cleared, but it still has to be acknowledged. In this case, the acknowledgment is a kind of confirmation that

someone has noticed the alarm. Details of the reset and the acknowledgment are both recorded in the alarm history.

- **Automatic reset, without acknowledgment:** there is no need for a user to acknowledge the alarm. The alarm is cleared when the error is no longer active as defined in the alarm conditions. You can specify delay and hysteresis values in the condition.

5.4 Alarm List

Here all the alarms in the system are listed.

Application - Channel - Alarm	Priority	Alarm message	Acknowledgement type	Edit
Larmtester.Applikation1 - Kanal1 - Larm1	A-alarm	Automatisk återställning, ingen kvittering	Automatic reset, no acknowledgement	
Larmtester.Applikation1 - Kanal2 - Larm2	B-alarm	Automatisk återställning, ingen kvittering	Automatic reset, no acknowledgement	
Larmtester.Applikation1 - Kanal3 - Larm3	A-alarm	automatisk återställning, ingen kvittering	Automatic reset, no acknowledgement	
Larmtester.Applikation1 - Kanal4 - Larm4	A-alarm	Återställning vid kvittering	Reset when acknowledged	
Larmtester.Applikation1 - Kanal5 - Larm5	A-alarm	Automatisk återställning med kvittering	Automatic reset, with acknowledgement	
Larmtester.Applikation2 - Kanal1 - Larm1	A-alarm	Automatisk återställning, ingen kvittering	Automatic reset, no acknowledgement	
Larmtester.Applikation2 - Kanal2 - Larm2	A-alarm	Automatisk återställning, ingen kvittering	Automatic reset, no acknowledgement	
Larmtester.Applikation2 - Kanal3 - Larm3	A-alarm	automatisk återställning, ingen kvittering	Automatic reset, no acknowledgement	
Larmtester.Applikation2 - Kanal4 - Larm4	A-alarm	Återställning vid kvittering	Reset when acknowledged	
Larmtester.Applikation2 - Kanal5 - Larm5	A-alarm	Automatisk återställning med kvittering	Automatic reset, with acknowledgement	
Larmtester.Applikation2 - Kanal6 - Larm6	A-alarm	Automatisk återställning, ingen kvittering	Automatic reset, no acknowledgement	

5.5 Alarm Groups

Here you create **alarm groups**. An alarm group defines which alarms are included, either by priority or a selection of individual alarms. Alarm groups are used for managing alarm sendouts for both email and texts (if this unit can handle texts).

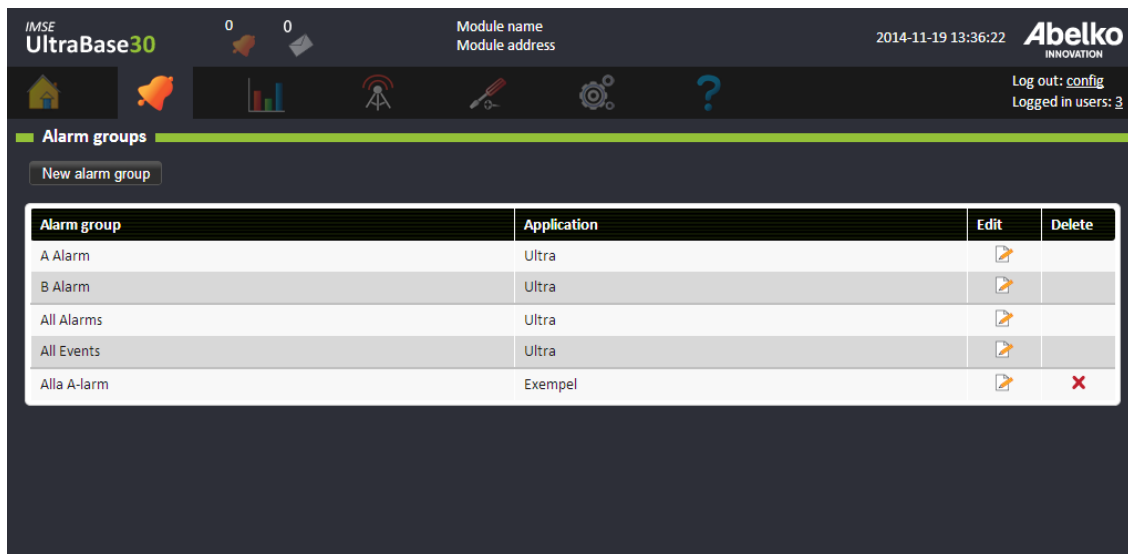

Create a new alarm group

1. Click **New alarm group**.
2. **Name** the alarm group.
3. Then choose **Language** for the mail sendouts and under **Type** you can choose which format the mails should have. You can also create your own format.
4. Select which alarms you want in the alarm group by clicking the box next to the alarms.
5. For example, if you would like to add all **A-alarms**, click the box next to the **A**. By doing this, all future **A-alarms** created in the application will be included in the alarm group.

New alarm group ✕

Name Application Ultra

Language
Swedish ▾

Type
Standard mail format for Comprobo ▾

Alarm priorities

A B
 C D E F G H I J K L M N
 O P Q R S T U V W X Y Z

Application	Channel - Alarm	Priority
<input type="checkbox"/> Regulator	Framledning 1 - Framledning Larm	A
<input type="checkbox"/> Regulator	VV Reglerfel - LARM_VVC_REGLERFEL	B
<input type="checkbox"/> Regulator	Reglerfel - LARM_REGLERFEL	A

6. Click Save.

Email settings for sendouts are configured under the menu **Alarm, Alarm sendouts**.

5.6 Alarm Sendouts

Here you create and edit alarm sendouts. Alarm groups must be created before editing alarm sendouts (see previous chapter).

IMSE UltraBase30 0 0 Module name Module address 2015-06-18 13:33:22 Abelko INNOVATION Log out: config Logged in users: 1

Alarm sendouts

Alarm group	Information	Recipients	Contact information	Edit	Delete
A Alarm					
B Alarm					
All Alarms					
All Events					

Add a recipient

1. Click on the icon under **Recipients** on the alarm group you want to add to.
2. Select an already existing recipient (these are created under the menu **Communication, Send-outs**) in the drop down menu or create a new by entering name and contact information. **Mail host** is mandatory since all email recipients need to be tied to an email server. If you don't have any mail hosts here you need to fill the settings under the menu **Communication, Mail host**.

New alarm recipient ✕

Recipients
 Jessica ▾

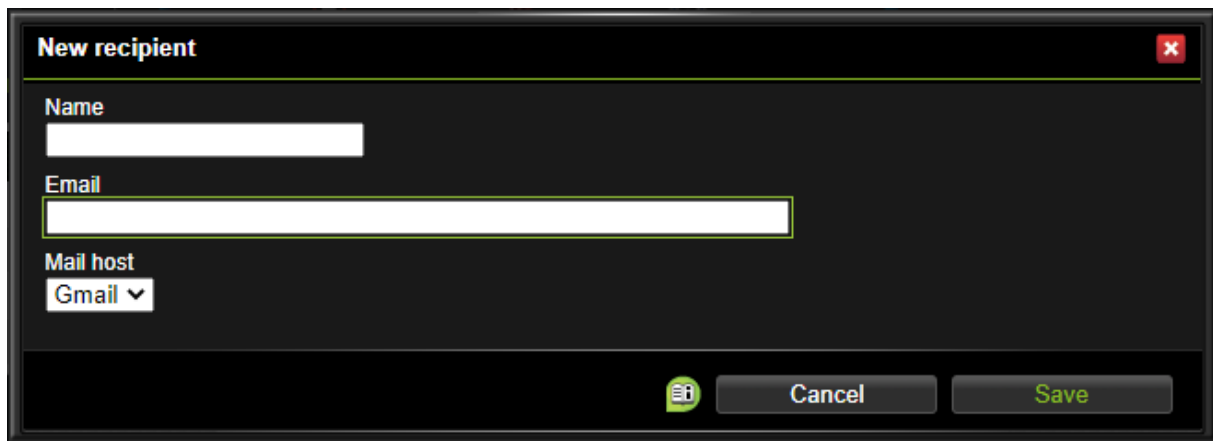
A dark-themed dialog box titled "New recipient" with a red close button in the top right corner. It contains three input fields: "Name" (a short text box), "Email" (a long text box), and "Mail host" (a dropdown menu currently showing "Gmail"). At the bottom, there is a green "Add" button with a plus icon, a grey "Cancel" button, and a grey "Save" button with green text.

New recipient ✕

Name

Email

Mail host
Gmail ▾

 Cancel Save

3. Click **Add**.

The system will send an email to all recipients each time an alarm in the alarm group turns active or inactive. The mail contains information about the alarm event. The mail can either be sent to people or to an alarm server.

6 Logging data

Logs are history of what has happened in the system, and are used to create statistics. This chapter will explain how to create and edit logs.

Logs are created under channel settings both in the **graphical programming** and under the menu **Configuration, Applications & resources**.

6.1 Types of logs

Type	Description	Interval
Instantaneous	Each log point contains the instantaneous value at that time.	1s, 2s, 15s, 1min, 5min, 15min, 1h, 24h, 1 month
Smart	The smart log has per second resolution closest in time, but compresses (spreads out) older log values by calculating averages. This allows long history (from the commissioning of the installation) with lower memory usage. The smart log is for example useful when logging temperatures where a long history is required.	Variable
When changed	A log point is created every time the value changes. Used when logging changes that happen occasionally, for example a light switch.	Variabel
Change	This type of log shows the difference in value since the previous log point. For example used when logging daily or monthly consumptions.	1s, 2s, 15s, 1min, 5min, 15min, 1h, 24h, 1 month

Type	Description	Interval
Max/Min	Each log point consists of the max or min value since the previous log point. The min- and max values are calculated as a rolling average with per second resolution.	1s, 2s, 15s, 1min, 5min, 15min, 1h, 24h, 1 month
Mean	Each log point consists of the mean (average) value since the previous log point. The mean is calculated with per second resolution.	1s, 2s, 15s, 1min, 5min, 15min, 1h, 24h, 1 month
Sum	The log sums the values since the previous log point. This is done with per second resolution. The sum log can be used for example when calculating operating time.	1s, 2s, 15s, 1min, 5min, 15min, 1h, 24h, 1 month

Note that all logs except for smart log are implemented as circular buffers. This means that older log values will be rotated out of memory when the buffer is full. There is a reserved memory for each log area, which is not affected by the other logs. For example; the contents of the long term log are not affected by the short term log filling up and rotating out old log values. The exception is the smart log where older values are not deleted, they are instead converted to longer intervals.

These are the log areas:

Log area	Contents
Smart	Smart logs
Short term	Periodic logs with interval < 1h
Medium term	Periodic logs with 1h < interval <= 24h
Long term	Periodic logs with interval >= 1h
Change	Change logs

Log area	Contents
When changed	When changed logs

6.2 Create logs

1. Go to a channels settings (in the **graphical programming** or under the menu **Configuration, Applications & resources**).
2. Click on **Add** to add a log. You can have different types of logs for the same channel.
3. Choose **type** of log, set **range** and **offset**.
4. Click **Save**.

6.3 View logs

Data logs are used for viewing plots of historical data for log points (for example channels or parameters). A view can be saved to be opened later. It is also possible to configure sendouts for saved views.

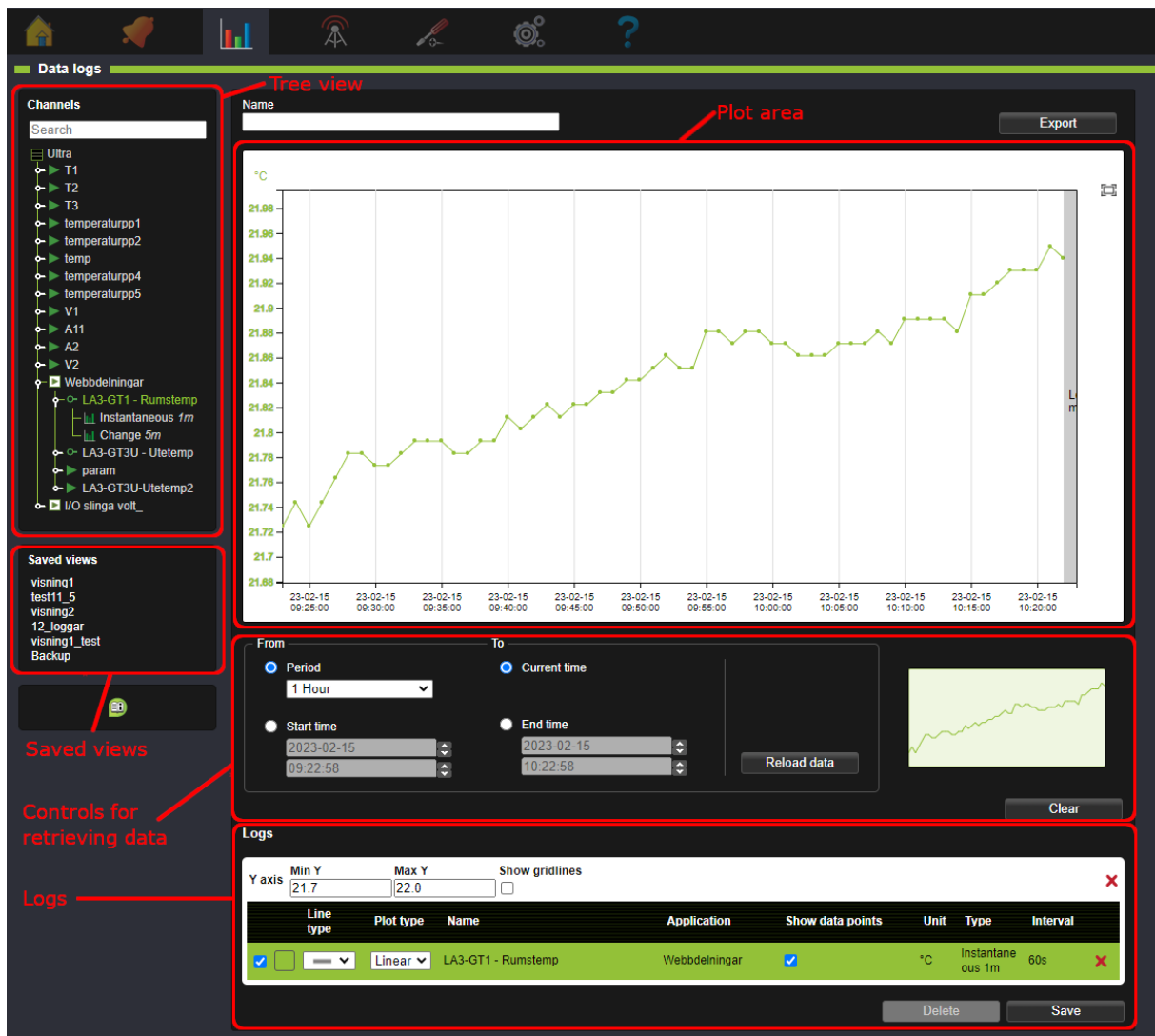

Treeview: Displays log points that can be added as logs. Only channels and parameters that have logging enabled can be displayed in data logs. This is done in the settings for each channel.

Plot area: The area where plots for the logs are displayed.

Controls for retrieving data: Settings that control the time period for which data is displayed.

Logs: List over the log points that are added as logs in the plot.

Saved views: List of saved views.

6.3.1 Add a log to a plot

A log point is added by drag-and-dropping it from the tree view to the plot area. The log will be added with its own Y-axis. Maximum 10 Y-axis can be added. Note that logs with short log intervals (for

example per second logs) can take a long time to load for long time periods.

To add a log to an existing Y-axis, drop it directly on that axis in the plot area. When a log is added to a plot it is also listed under **Logs** below the plot area.

The Y-axis may use SI-prefixes when displaying very large and small values. For example:

μ micro (0.000 001)

m milli (0.001)

k kilo (1 000)

M mega (1 000 000)

6.3.2 Selection of time period

Controls for retrieving data below the plot area controls which time period the plot displays. To change the time period, select the desired settings and click **Reload data**. If period is set to **Auto** and a log is added, the x-axis will automatically be scaled to suit the type of log. If the selected time period contains a large amount of measurement points the loading can take a long time. To abort, click **Stop loading**. New settings can then be selected with a shorter time period, or fewer measurement points.

The miniature image shows an overview of the selected time period. Current zoom level is displayed as a shadowed area in the miniature image.

The button **Clear** removes all logs that are currently displayed in the plot area.

6.3.3 Logs

Logs displays a list of all the Y-axis and which logs are under each Y-axis.

Min Y and **Max Y** controls the min and max values for the Y-axis in the plot area.

Show gridlines controls whether gridlines are displayed or not.

Show data points controls whether data points are displayed or not. Data points cannot be displayed for logs with a large number of data points.

The checkbox next to each log controls whether the log shall be visible or not.

A Y-axis with more than one logs will have the same unit and colour as the currently selected log. Click on a log to select it.

Line type and **Plot type** controls the appearance of a log in the plot.

Clicking the red crosses  removes a Y-axis (with all its logs) or an individual log from the view.

6.4 Zoom and pan

6.4.1 Zoom with mouse wheel

The mouse wheel can be used to zoom in or out in the plot. If the mouse cursor is over the plot area and the mousewheel is scrolled both the X- and Y-axis will be zoomed. If the cursor is over a specific X- or Y-axis, only that axis will be zoomed.

6.4.2 Zoom with selection

Right click and drag in the plot area to select an area to zoom in on.

6.4.3 Pinch zoom (only works with touch screen)

If a touch screen is used pinch zoom can be used to zoom in the plot. Pinch with two fingers to zoom in or out in the plot.

6.4.4 Reset zoom

Use the button reset zoom  to reset the zoom to display the whole plot in the selected time period.

6.4.5 Pan

Click and drag in the plot area to pan. Click and drag an individual axis to pan only that axis.

6.5 Tooltip

When the mouse pointer is hovered over the plot a tooltip is displayed.

- If the pointer is over a data point the value and timestamp of the data point is displayed. The data point is marked in the color of the log.
- If the pointer is between data points an interpolated value and its timestamp is displayed. The interpolated point is marked in black.

6.6 Saved views

A saved view saves the current view of one or more logs so that the same view can be opened later.

Saved views are also used for log sendouts, see chapter Log Sendouts

6.6.1 Create saved view

To save the current view, enter a name for it and click Save. The saved view will then be displayed in the section Saved views. Saved views with sendouts are indicated with a letter symbol .

A saved view stores:

- Which logs are included in the view, and which Y-axis they are connected to.
- Line colour, Line type och Plot type.
- Selected log (determines unit and colour of the Y-axis).
- Which logs are selected to be visible (determined by the check box)
- Time period settings in **Controls for retrieving data**

6.6.2 Delete saved view

To delete a saved view, first open it by selecting it in the list. Then press the button **Delete**. A saved view with sendouts cannot be deleted. In that case the sendout must first be removed. See chapter Log Sendouts.

6.6.3 Modify saved view

To modify a saved view, first open it by clicking it in the list. It can then be modified, for example by adding or removing logs. Then click **Save**. Note that modifying a saved view with sendouts also affects the sendouts.

6.6.4 Export data

The button **Export** above the plot area allows exporting the currently viewed logs in CSV-format.

6.7 Log sendouts

Here you can export a log based on your saved log views.

IMSE UltraBase30 0 0 Module name Module address 2015-06-18 13:47:34 Abelko INNOVATION Log out: config Logged in users: 1

Log sendouts

Data logs	Recipients	Contact information	Edit	Delete
Undercentral A				
	Jessica	jessica.rohdin@abelko.se		
Framledning Undercentral A				
Manuell växling 1 + drift				
Framledning 1				
VV reglerfel				

1. Add a new recipient next to the log you want to export.

New log recipient

Recipients
 Jessica ▾

▲ Create new recipient

Name

Email

Mail host
 Abelko intern ▾

Create new

Cancel Add

2. Select an already existing recipient (these are created under the menu **Communication, Send-outs**) in the drop down menu or create a new by entering name and contact information. **Mail host** is mandatory since all email recipients need to be tied to an email server. If you don't have any mail hosts here you need to fill the settings under the menu **Communication, Mail host**.
3. Click **Add**.

4. When you have the recipients click **Edit** for a **Data log**.
5. Set **Period time** (how often you want it to be sent) and an **Offset** if needed (how far into the period time you want the transfer to take place).
6. Click **Save**.

The first time, it will send all the data. After this, it will remember what it has sent and only send new data (all data collected after the last transfer).

Below is an example of a log sendout.

```
DUC Apartment 4, Abelko house, Luleå
00-30-5E-0B-01-8C
1, Database log
Index      1          2          3          4
Channel number 77      10      11      12
Channel name  GT20 [mean]  GT21 [mean]  GT22 [mean]  GT23 [mean]
Channel unit   °C      °C      °C      °C
2015-07-04 14:54:00      20.881987      20.620169      20.076967      18.460488
2015-07-04 14:55:00      20.881661      20.620006      20.081535      18.458369
2015-07-04 14:56:00      20.881008      20.622453      20.079088      18.459184
2015-07-04 14:57:00      20.883946      20.620658      20.077946      18.458695
2015-07-04 14:58:00      20.882803      20.622779      20.078761      18.459347
2015-07-04 14:59:00      20.885578      20.623106      20.078598      18.460488
2015-07-04 15:00:00      20.885741      20.623758      20.07974      18.459347
2015-07-04 15:01:00      20.887047      20.626043      20.082025      18.460162
2015-07-04 15:02:00      20.887863      20.624574      20.081698      18.460162
2015-07-04 15:03:00      20.889822      20.626859      20.083167      18.460488
2015-07-04 15:04:00      20.891127      20.626206      20.080882      18.45951
2015-07-04 15:05:00      20.890801      20.627185      20.081698      18.461139
2015-07-04 15:06:00      20.890474      20.627185      20.079577      18.459347
2015-07-04 15:07:00      20.891454      20.627185      20.078761      18.458858
2015-07-04 15:08:00      20.890474      20.627185      20.079903      18.459999
2015-07-04 15:09:00      20.890801      20.62849      20.080719      18.459184
2015-07-04 15:10:00      20.89178      20.628164      20.079251      18.456088
2015-07-04 15:11:00      20.891454      20.628817      20.080393      18.457555
2015-07-04 15:12:00      20.893412      20.629796      20.081698      18.457555
2015-07-04 15:13:00      20.895371      20.630612      20.082514      18.458369
2015-07-04 15:14:00      20.895371      20.630938      20.083983      18.458858
```

At the top you can see from which device the mail comes from, with name and MAC address. You can see what type of log it is (1, database log) and below that, all channel numbers and channel names

with units are listed. Under these you can see a timestamp and which value the channel had at that time. There is not always data for each time point for each channel.

7 Communication

The **Communication** menu allows access to the systems network configuration, overview of alarm- and log sendouts, settings for outgoing mail and modbus settings.

7.1 Network

Network allows you to handle network settings for **Ethernet** and see information about **Local PC**.

The screenshot shows the 'Network' configuration page for the IMSE UltraBase30. The page is divided into two main sections: 'Ethernet settings' and 'Local PC information'. The 'Ethernet settings' section includes a checkbox for 'Using DHCP', which is currently unchecked. Below this are input fields for 'IP address' (10.2.3.20), 'Netmask' (255.255.254.0), and 'Gateway' (10.2.2.1). There are also three input fields for 'DNS server 1' (10.1.0.18), 'DNS server 2', and 'DNS server 3'. The 'MAC address' is displayed as 00:30:5e:0b:01:4e. At the bottom of this section is a dropdown menu for 'Allow unencrypted connection' set to 'Yes'. A 'Save' button is located at the bottom right of the 'Ethernet settings' section. The 'Local PC information' section displays the following details:

Local PC information	
IP address	192.168.142.1
Netmask	255.255.255.0
MAC address	16:20:e5:83:85:25

Allow unencrypted connection controls whether or not it is possible to connect to the Ultra with unencrypted communication (with HTTP on port 80). If the connection is done with HTTP all communication, including login credentials, will be sent unencrypted over the network. Unencrypted communication is generally not recommended. To connect to the Ultra with encrypted communication the URL shall start with `https://`, and to connect with unencrypted connection it starts with `http://`.

If you change the IP address and click **Save**, you will be logged out from the system. Enter your new

IP address up in the address bar in order to log in again.

Note: IP-addresses on the 192.168.142.XXX network are reserved for the **Local PC** port*, and not possible to set for the **Ethernet** port.

You can always connect with a PC with a cable directly to the **Local PC** port to change network settings if you cannot access the device on the **Ethernet** port. The **Local PC** port has the fixed address **https://192.168.142.1** and uses DHCP to automatically assign your PC a IP address on the Local PC network.

Note: If the Ultra is on a network behind a router or firewall it needs to be ported out before it can be accessed from the outside. Contact the person responsible for your network environment to configure this in the network.

7.2 Mail Host

Here you can edit the settings for the unit's mail host. This setting is required in order to send emails for both alarm and log sendouts.

The screenshot shows the 'Mail host' configuration page in the Abelko UltraBase30 web interface. The page header includes the device name 'IMSE UltraBase30', status indicators (0), and the Abelko logo. The main content area is titled 'Mail host' and contains a form for configuring an email server. The form fields include: Host name (filled with 'Abelko intern'), Host, Port, and From (all empty), Authenticate (set to 'Off'), Username, and Password (all empty). There is also an 'Optional settings' dropdown menu. At the bottom of the form are buttons for 'Send test mail', 'Delete', and 'Save'.

1. Enter **Host**, **Port** and a valid **email** for the mail host.
2. **Host name** is used to distinguish the different servers in the system.
3. Many email servers require **authentication**. Select **Auto** and enter **Username** and **Password** for the email server (this is something you receive from your Internet service provider).
4. Click **Save**.

All email recipients are tied to an email server defined in the settings. You can define more than one email server.

7.3 Recipients

View and edit all the people registered in the system. You can also add new recipients. This section gives you an overview over which alarm and log sendouts the different recipients will receive.

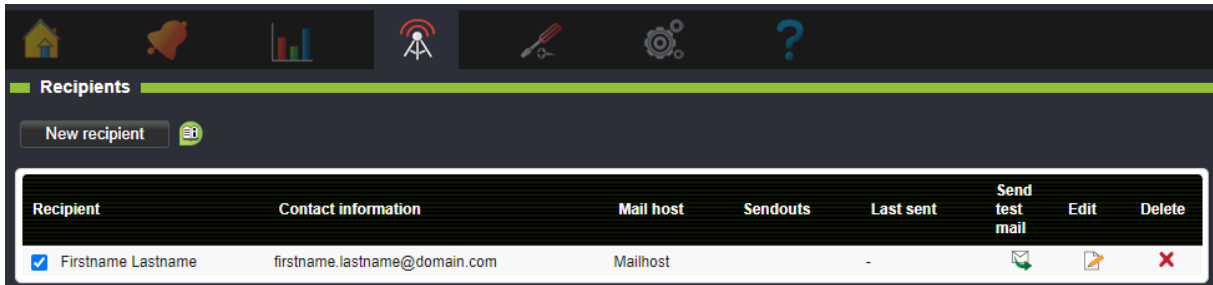

You can inactivate a recipient with the box next to the recipient's name. You can also send a test mail.

7.4 Modbus Slave Register

Modbus is a protocol used to communicate between devices. Here you create and edit register lists for Modbus-slave-communication.

Export lists

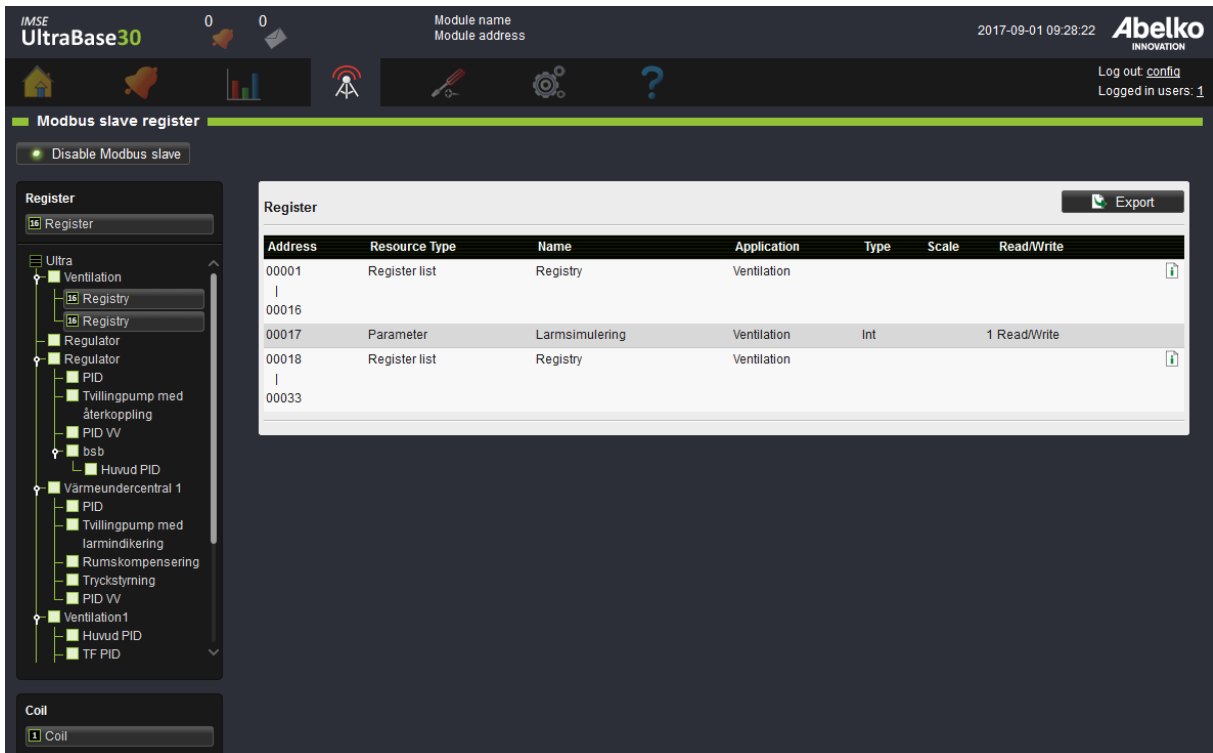

You can export two lists, one for Register and one for Coil.

1. Click on the top list for each type.
2. Click on **Export**.
3. Choose format, **CSV** or **Print**.

7.5 Modbus Slave Settings

Here you activate and edit the Modbus slave function.

7.6 Modbus TCP Gateway

Here you create rules for the external units placed under **Modbus TCP Gateway** on the page **External units**.

7.7 RS485 Ex settings

On this page, the EX-port is configured. The EX-port can either be used for expansion modules, under **In- & Outputs**, or as an RS485-port for **External units**. If it is used for External units, it is recommended to use an ExConnect module for conversion from modular cable to screw terminal.

7.8 External devices sendouts

On this page, you create sendouts for external devices. This is a function that periodically sends email with all values for all external devices of a particular type. The function is primarily intended to be used to send meter indications to automatic collection systems, such as invoicing. You can collect information from many meters without having to connect them to channels or logs. What's included in the sendout is the external device name, when it was last updated, status and value.

7.9 Portal Update

This is a function that, together with a portal server, such as portal.abelko.se, helps keep track of the unit's IP address.

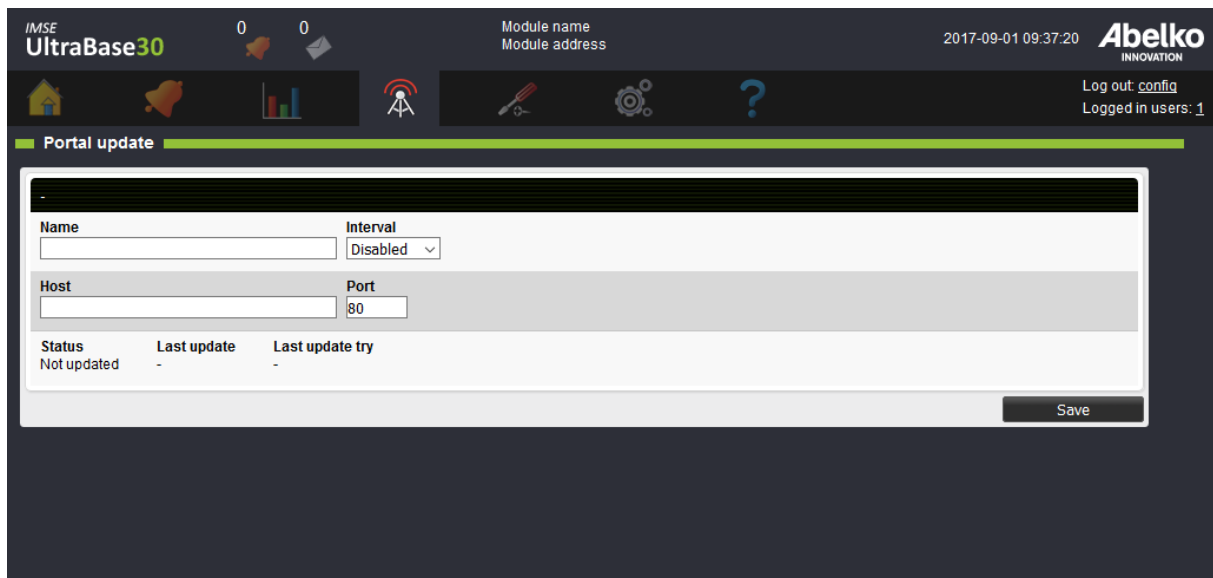

1. Enter a **name**.
2. Set how often (**interval**) you want the unit to update its address with the server. If you use a mobile subscription or have a connection that changes the IP address frequently, set a short interval. If you have a connection that does not change the address very often, such as fiber or DSL, set a high interval.

On our portal **portal.abelko.se**, you can use the units MAC address, view its current IP address and view when the unit was last connected to the server and updated it.

3. When you found your unit (using the units MAC address) save the result page as a bookmark. This gives you a link that is updated with the most recent address as long as the unit is connected to the Internet.

Please note that the portal service only gives you a link to the product, you do not surf through the portal.

7.10 Companion

You can use the companion function to see active alarms, alarm history, overviews and summary pages from many IMSE Ultra devices in the user interface of one Ultra. This enables a good overview of a plant without the user needing to log in to several devices and switching between tabs. To achieve this you configure all devices as companions to one main companion device that can show all information.

A main companion can display information from up to ten other devices. These are configured to connect to the main companion, and give it information access. A user that logs in at the main companion

automatically has access to settings in all companions with the same access level.

When companions are configured they exchange cryptographic keys in a pairing procedure. After that, both sides can be sure of the identity of the other side when they henceforth connect automatically. The communication is encrypted and is safe to use over public networks.

An IMSE Ultra device can be simultaneously be a main companion for ten devices, and share information as a companion to ten other devices.

7.10.1 Showing alarms

Alarms in active companions will be displayed in a separate alarm icon at the top of the interface. The icon works in the same way as the other icon for active alarms.

With active companions, the appearance of the Active alarms and Alarm history pages will change. There will be check boxes for each companion device, including the main device you are logged in to, above the alarm lists. You can use them to filter which devices you want to see alarms from.

There is also a new column in the list, **Device Name**, to show which device an alarm belongs to. The names used in the table and for the check boxes are the devices settings for Module name. It is set in the menu **System / Settings**, and is the name showed in top row of the web page.

The tables work as usual, for the companion, and you can also receive alarms from the companions.

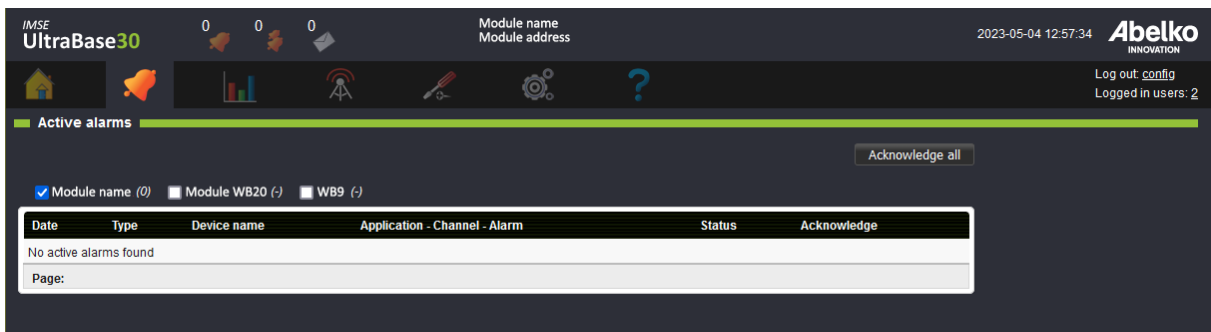

7.10.2 Home, overviews and summary pages

On the home page there is normally a tree view that enables access to overviews and summary pages. When companions are active, there is an additional tree for each companion device. For each companion there is also a counter for active alarms in that device. These tree menus works just as normal, and are shown as they are shown in the devices they originally come from.

IMSE UltraBase30 0 0 0 Module name Module address 2023-05-04 15:01:51 **Abelko** INNOVATION

Log out: [config](#)
Logged in users: 2

Home

Views

- Ultra
 - UC1
 - UC3
 - Larm
 - UC1
 - UC3

Companions 0 0

WB20 0 0

- Ultra
- UC3

samma_6

Ventilation

LA3-GT3U - Utetemp	5.5 °C
Utetemp	0.0
Param1	0.0
LA3-GT3U - Utetemp	5.5 °C
temperaturpp1	58.9

8 System

This chapter will explain the note tool and the file manager. You will also learn how to create backups and update the system.

8.1 Notes

In **Notes**, you can create notes and see changes made in the system. If you have made changes in the system that you want the other users to know of, you can create a note about it here. A new note is indicated by the mail icon on top of the interface for the other users. Click on the icon to view the note or open the menus **System** and **Notes**.

Note	User	Time	Edit	Delete
! Be sure to check the door when you enter!	config	2014-10-23 13:46:36		
I changed the sensor in room 2. /SH	config	2014-11-21 11:18:44		

1. Click **Create new**.

Create note

Note

High priority

Cancel Save

2. Add a note and your name. You can mark the note as **High priority**. This means that it will be placed at the top of the list with an exclamation mark.

3. When you click **save**, all users will have a new note to read.

Click on a note in order to read the whole note.

By clicking **Mark all as read** the letter symbol for new messages will be turned off for the user who is logged on.

8.2 File Manager

All system files are available in the **File manager**. You can copy a file to the PC from the system by clicking on the **Download**-icon.

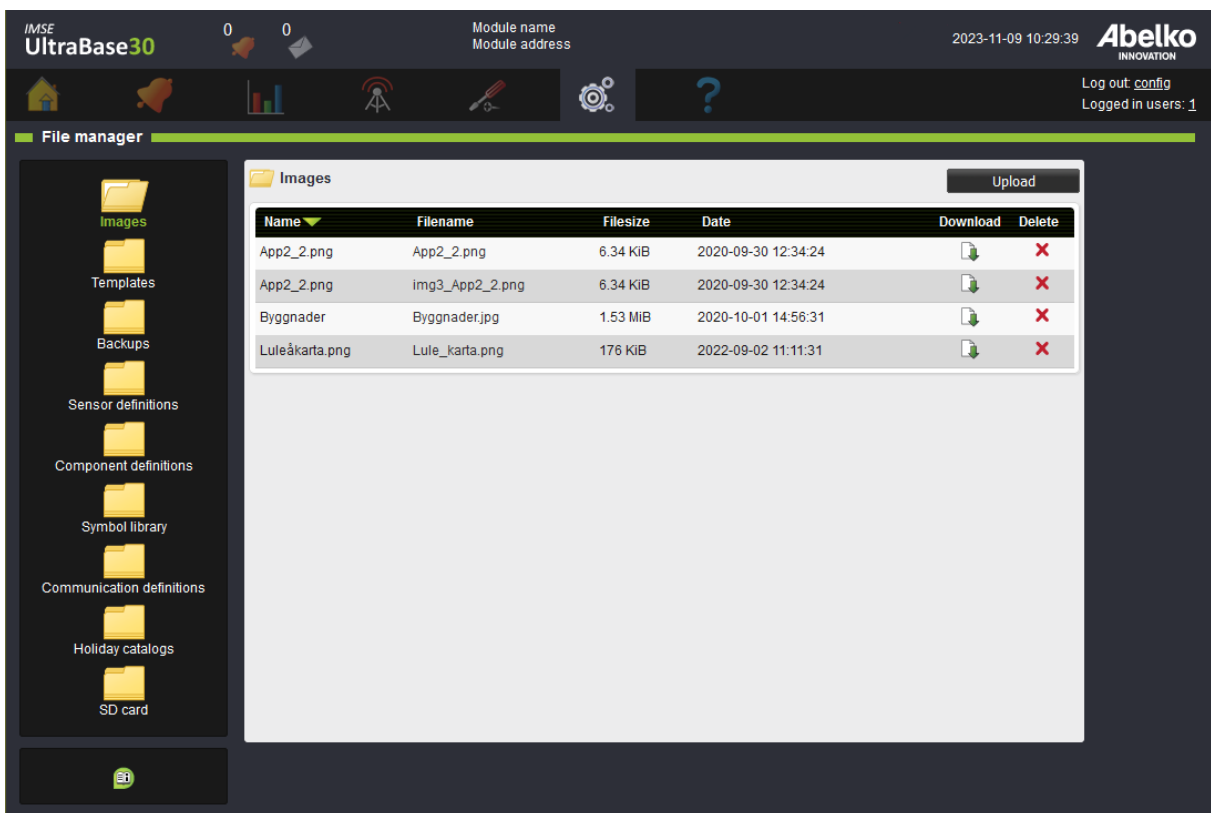

Upload files to the system through the predefined folders.

Images: upload images for overviews and other pages. The recommended formats are jpeg, png and gif. It is also possible to upload pdf-files or other files that you want to create links to from the summary pages.

Templates: upload application templates that were created in an Ultra. All templates that were created in the device can be found here. You can download the files to your computer by clicking on the file name.

Backups: upload application backups containing parameter banks (no user settings, IP address or network settings) from an Ultra. All backups that were created in the device can be found here. You can download the files to your computer by clicking on the file name.

Sensor definitions: upload definitions for sensors and actuators.

Component definitions: upload components to use in the graphical programming.

Symbols: upload symbols to use when you create overviews.

Communication definitions: upload definitions for external units and expansion modules. Usable definitions are available at script.abelko.se.

Holiday catalogs Upload holiday catalog files with format json to use when creating time schedules. When creating your own files, use following format:

```
{ "Items": [ { "Name": "New Year's Day", "Date": "2023-01-01", "Weekday": 7 }, { "Name": "Epiphany", "Date": "2023-01-06", "Weekday": 7 }, { "Name": "Good Friday", "Date": "2023-04-07", "Weekday": 7 } ] }
```

Name: is the name of the day. **Date:** is the date of the day, YYYY-MM-DD. **Weekday:** is the weekday you want the date to be counted as, where 1 = Monday, 2 = Tuesday and so on.

SD card: If there is an SD card in the front of the UltraBase30, you can see its content here.

8.3 Users

Create and edit users.

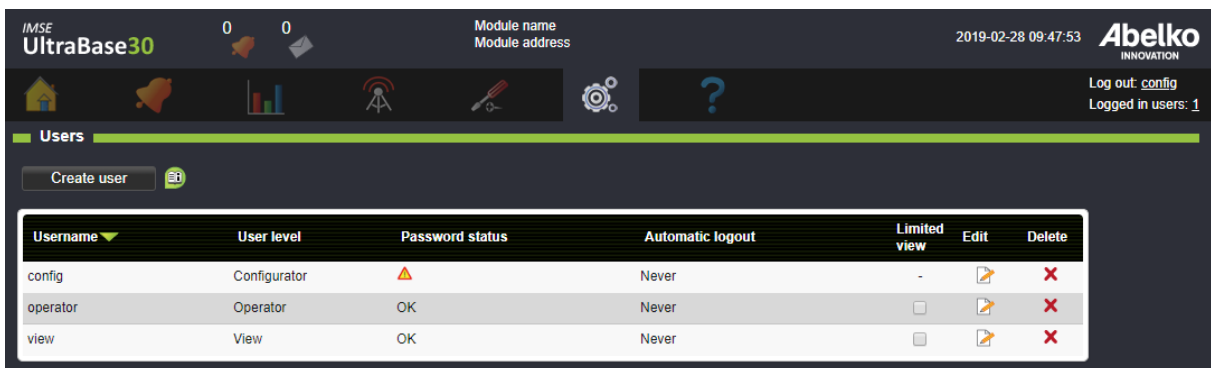

Username	User level	Password status	Automatic logout	Limited view	Edit	Delete
config	Configurator	⚠	Never	-		
operator	Operator	OK	Never	<input type="checkbox"/>		
view	View	OK	Never	<input type="checkbox"/>		

Change password

1. Click **Edit**.
2. Enter your new password and click **Save**. If you click **Cancel**, your old password will still be valid.

Create new user

1. Click **New user**. Only a configurator can create new users.

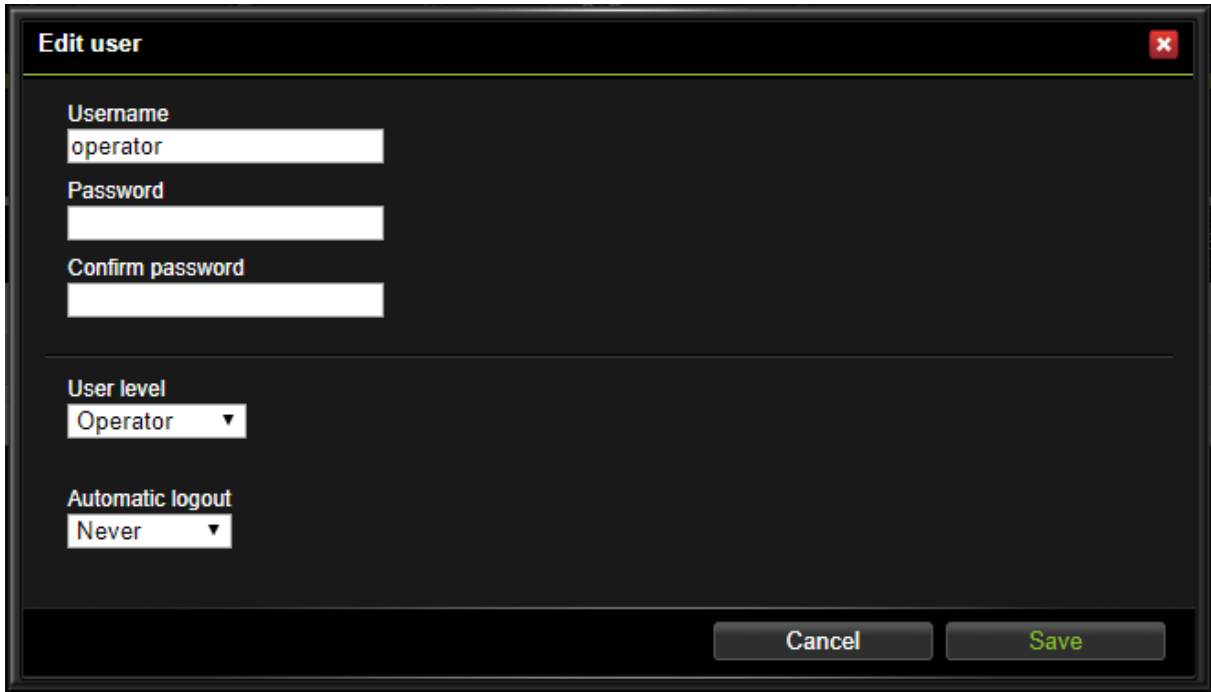

The screenshot shows a dark-themed dialog box titled "Edit user". It features three text input fields for "Username" (containing "operator"), "Password", and "Confirm password". Below the inputs are two dropdown menus: "User level" (set to "Operator") and "Automatic logout" (set to "Never"). At the bottom right, there are "Cancel" and "Save" buttons.

2. Add a **username** and a **password**.
3. Select a **user level**.
4. Select if **Automatic logout** shall be active by selecting a timeout.
5. Click **Save**.

User levels

User level	Description
Configurator	Has full rights, can configure the whole device, upgrade the software, restore backups, and more.
Operator	May change settings and is intended for those who will take care of the facility.
View	Allows the user to view the user interface, but not to change anything.

Password status indicates that the standard password has not been changed. If it has not been

changed, a warning triangle is shown, otherwise, the text OK is shown.

Automatic logout shows the interval in which the user must be active before automatically being logged out.

Limited view means that the user can only see the following menus:

- Home: Overviews and summaries
- Alarm: **Active alarms** and **Alarm history**
- Data: **Data logs**
- System: **Notes** and **Information**
- Help: **Manuals** and **Support**

8.4 Settings

Enter the name and the address of the module under the menus **System** and **Settings**. Here you can **choose start page**, choose between overviews and summaries. Settings for date and time are also located on this page. NTP is recommended to automatically synchronize date and time. You can also **clear history** and **reboot** the system if needed.

Log out: [config](#)
Logged in users: 1

Settings

Settings

Module name Module address

Choose start page

Type Overview Name
 Summary
 Active alarms

Custom tree view

Show on startpage:

Expand companion trees.

Set time

Date Time

Activate NTP
NTP server:

Other settings

Tag separator Suffix separator

Clear history

Clear all alarm history and/or data logs in this unit. The change history will not be cleared.
The system will be rebooted and you will be able to login again after the reboot has been completed.

Alarm history
 Data logs

Reboot

The system will be rebooted and you will be able to login again after the reboot has been completed.

8.5 Backups

Here you can upload, create, export and restore **application backups** and **system backups**.

The screenshot shows the 'Backups' section of the UltraBase30 web interface. It is divided into two main panels: 'Application backups' and 'System backups'.

Application backups: This panel includes an 'Upload' and 'Create new' button. Below is a table with columns for Name, Description, Date, Delete, Export, and Restore. Two entries are visible: '2016-12-19' and 'FactoryDefaults'.

Name	Description	Date	Delete	Export	Restore
2016-12-19		2016-12-19 10:15:23	X	📄	🔄
FactoryDefaults		2015-11-12 10:10:23	X	📄	🔄

Page: 1

System backups: This panel includes a 'Create new' button and a section for 'Automatic backup to SD-card'. It features dropdown menus for 'Periodically' (set to 'Never'), 'Time' (set to '00:00'), and 'Day' (set to 'Monday'), along with a 'Save' button. A message states 'Automatic backups are disabled'. Below is a table with columns for Name, Date, Delete, Export, and Restore. Three entries are visible, all with names starting with 'ultraBaseBackup_...'.

Name	Date	Delete	Export	Restore
ultraBaseBackup_00000186_20150409_090054.tar.gz	2015-04-09 09:45:24	X	📄	🔄
ultraBaseBackup_00000186_20150415_130010.tar.gz	2015-04-15 13:15:26	X	📄	🔄
ultraBaseBackup_00000186_20150415_131557.tar.gz	2015-04-15 13:23:54	X	📄	🔄

Application backups: an application backup contains all files and settings that determine what the device does. This means all applications in graphical programming, application settings, summaries and overviews, configuration of inputs and outputs, and more.

An application backup does **not** include network settings, logged data, alarm history, and notes. You can use an application backup to reset settings before changes were made or to create a new device with the same function.

System backups: a system backup is a complete backup of all data and settings in the device. It also includes network settings, logged data, alarm logs and notes. The system backup is intended to be used to restore a replaced or broken device. It requires considerably more space than an application backup. On a UltraBase30 an external SD-card is used to store system backups. On a UltraBase20 one gigabyte of internal flash is used for a partition to store backups.

When you restore a system backup, the network settings are overwritten. If the backup contains settings that do not match the location of the device, you may lose contact with the device. User settings will be overwritten so user names and passwords may be changed. Logged data, alarm history and notes will also be overwritten. This means that, all information that was generated after the backup was created, will be lost.

NOTE! When using an SD card, it is important that it is formatted with the FAT32 file system. It is recommended to use an SD card that is 16Gb.

8.5.1 Create a new application backup

1. Click Create new.
2. Name the backup and add a short description.
3. Click Create new.

The backup is saved in the system and is added in the list of existing backups that you can delete, export and restore.

All backups are also available under the menu **System** and **File manager** in the **Backups** folder. There you can download an application backup to your computer or upload a previously saved backup to make a copy of an application.

8.5.2 Create a new system backup

To create a system backup on a UltraBase30, you need an SD card in the SD card holder on the front of your.

1. Click **Create New**. Here you can see how much free space is left on the SD card. Keep in mind that it may take a while to create a system backup. In a hard working device it may take more than an hour.
2. Click **Create New**.

The backup is saved on the SD card and is added in the list of existing backups that you can delete, export and restore.

8.5.3 Create an automatic system backup to SD card

An Ultra can be set up to periodically create a system backup. On a UltraBase30 this requires an SD-card.

1. Specify how often the backup should be created. Keep in mind that it may take a while to create a system backup. In a hard working device it may take more than an hour.
2. Click **Save**.

To make space for new backups the oldest automatically created backups will be deleted when necessary. If not enough space can be generated, or there is no SDcard, no backup will be generated.

8.5.4 Front panel buttons for SD-card on UltraBase30

At the front of an UltraBase30, there are two buttons to interact with the SDcard without using a PC. You can create and restore system backups, and update firmware from a SD.card using these buttons.

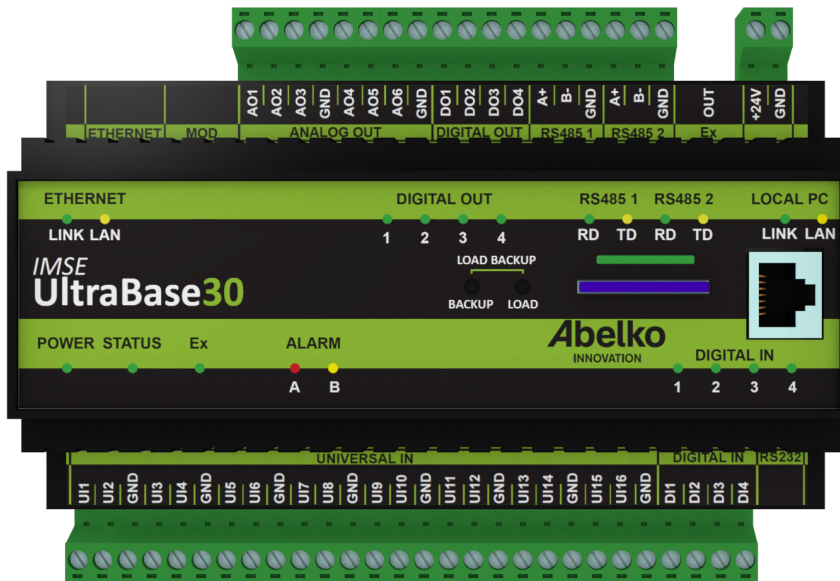

Note! If someone else is working on the device through the interface, the light above the SD card will flash green. Do not touch the SD card or the backup buttons during this process since it may interrupt their work.

Create a system backup with the buttons on the front

1. To create a system backup of the systems data to the SD card, hold the **BACKUP** button until the light above the SD-card starts to flash green.
2. The light above the SD-card will flash green during the whole process.
3. When the process is complete, the light will shine green for **5 seconds**. Now the backup is finished.

If an error should occur, the light will flash red for 15 minutes. A file will be transferred to the SD card with information concerning the error (as long as the card is not write-protected).

Note! SD-cards are not recommended for long term data storage. It is safer to transfer the backup file to a computer or similar.

Load a system backup with the buttons on the front

You can load a system backup into the system. The backup is usable when you, for example, want to replace an unit and need an exact copy.

1. To load a system backup, hold the buttons **LOAD + BACKUP** until the light above the SD-card starts to flash green.
2. When the process is completed, the light will shine green for **5 seconds**. Now the full backup is done.

If an error should occur, the light will flash red for 15 minutes. A file will be transferred to the SD card with information about the error (as long as the card is not write-protected).

If there is only one backup file on SD-card (in the file system root) it will be restored. If there are automatically generated backups the latest backup will be restored.

Execution of a load-file from SD-card (for example an update)

The file must be of type .load and may contain a software upgrades, parameter bank scripts and more. A .load file is created by Abelko on request.

1. To run a .load file, hold the **LOAD** button until the LED flashes green.
2. Depending on execution, the unit can be restarted. The LEDs will then go out for a few minutes.
3. When the process is complete, the light will shine green for 5 seconds. Now it's finished.

If an error should occur, the light will flash red for **15 minutes**. A file will be transferred to the SD card with information about the error (as long as the card is not write-protected).

8.6 Update

To update using the interface, go to the **Update** menu under the **System** menu.

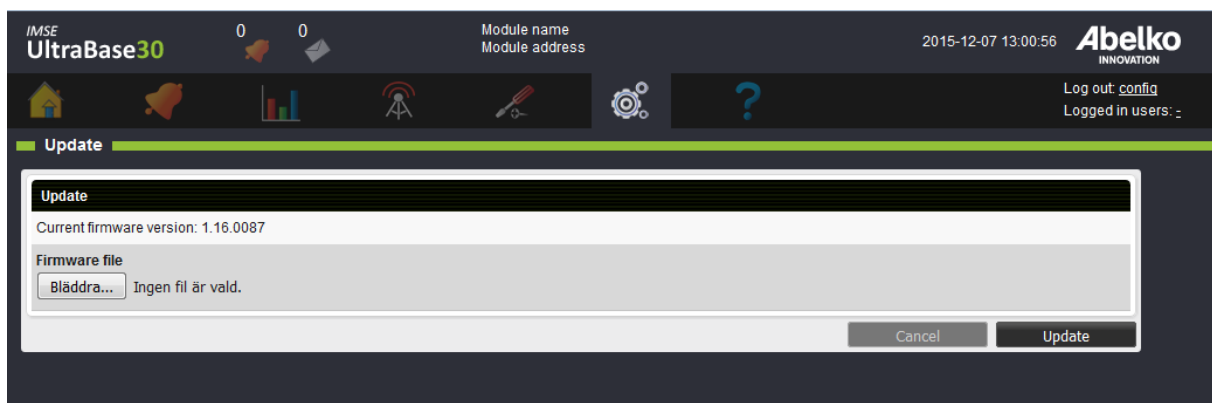

1. Select a firmware file.
2. Click **Update**. (**Note:** you can also update an UltraBase30 using an SD-card.)

3. You will soon see a new window with update information.
4. When the system has updated everything, you will be able to **log in** again.

8.7 Operator panel

Under the menu **System** and **Operator panel**, you can see status of the operator panel (if anyone is installed), edit password and language, and also customize the menus of the operator panel.

8.8 Information

Under the menu **System, Information**, you can view information about the system and its operation.

8.9 Change history

Under **System** and **Change history**, you can see history of which changes have been made in the system and by which user for selected resources.

9 Help

9.1 Manual

The manuals are available at <https://www.abelko.se>.

9.2 Support

Here you can find contact information for support.

10 The unit UltraBase20

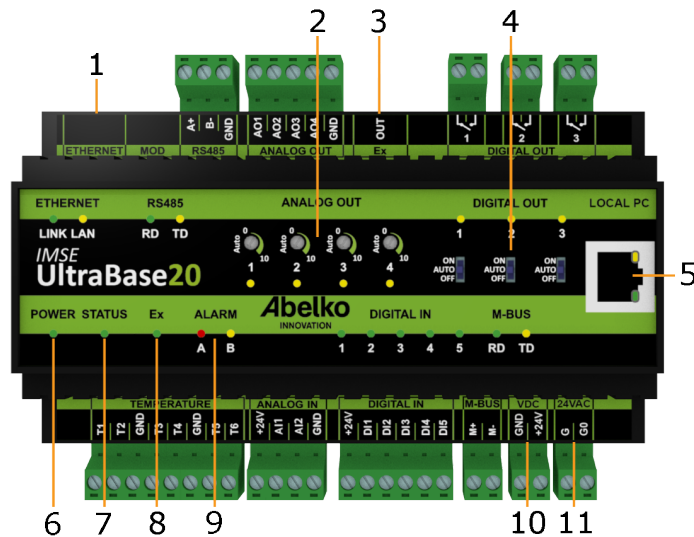

1. **ETHERNET** is used to connect to the network.
2. **ANALOG OUT** manual override. Turn right to activate manual override and increase the output voltage. When the corresponding yellow LED is lit manual override is active. Turn fully left to deactivate.
3. **Ex OUT** is used to connect to expansions modules. This port can also be configured as an RS485-port
4. **DIGITAL OUT** switch for manual override. Set to AUTO for normal operation. A yellow LED indicates a closed relay output.
5. **LOCAL PC** is used only for direct connection to a PC with address **https:\192.168.142.1**.
6. **POWER** shines green when the unit is powered.
7. **STATUS** shines green when the unit is running. It may take a little while before STATUS lights up when the unit is powered. If it does not light up, inputs and outputs are not working. If the status LED blinks, there is something wrong, go to menu Active Alarm for more information about the error.
8. **Ex** shines green when all the expansion modules that should be connected are running. If it blinks, a module is missing. Ex does not shine if the port is configured as RS485
9. **ALARM** has one red LED for A-alarms and one yellow LED for B-alarms. The LEDs blink if there are alarms that need to be acknowledged.
10. **VDC** is used to power the Ultra with 24 V stabilized DC.

11. **24VAC** is used to power the Ultra with 24 V AC power. Ex OUT is not powered on AC power.

10.1 Power supply

UltraBase20 can be powered i several ways. Requirements and characteristics of the unit's inputs and outputs can be found in the table below.

Port	Supply	Supply expansion module (port Ex)
VDC	24 VDC* (>300 mA)	24 VDC, 1A
24VAC	24 VAC (>300 mA)	No
	24 VDC* (>300 mA)	No

* Stabilized DC voltage.

11 The unit UltraBase30

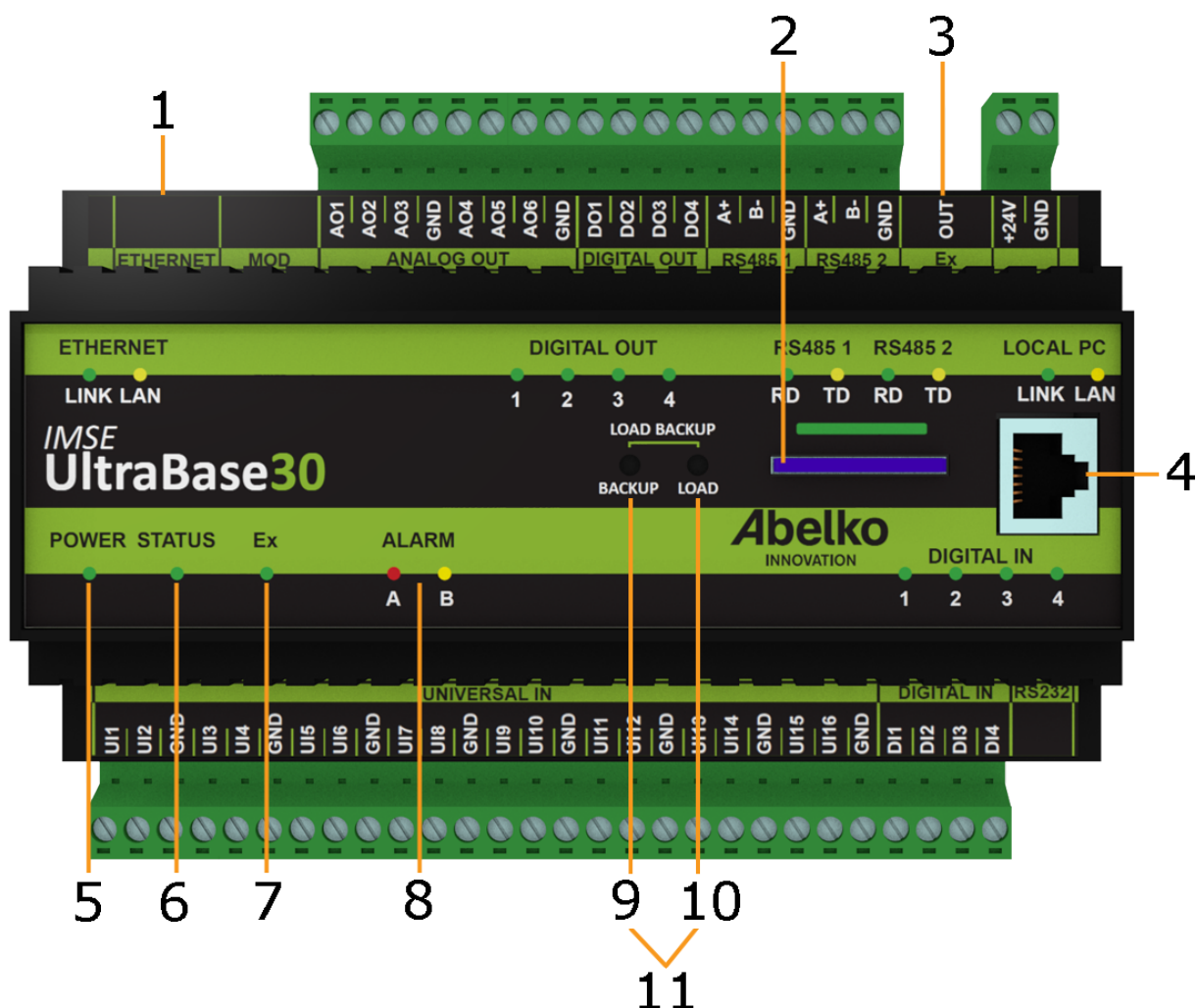

1. **ETHERNET** is used to connect to the network.
2. Place for SD card.
3. **Ex Out** is used to connect to expansions modules. This port can also be configured as an RS485-port
4. **LOCAL PC** is used only for direct connection to a PC with the address **https:\192.168.142.1**.
5. **POWER** shines green when the unit is powered.
6. **STATUS** shines green when the unit is running. It may take a little while before STATUS lights up when the unit is powered. If it does not light up, inputs and outputs are not working.
7. **Ex** shines green when all the expansion modules that should be connected are running. If it blinks, a module is missing. Ex does not shine if the port is configured as RS485
8. **ALARM** has one red LED for **A-alarms** and one yellow LED for **B-alarms**.
9. **BACKUP** is used to create a full backup of the system to the SD card.

10. LOAD is used to execute a .load file stored on the SD card. There may only be one .load file on the card. A .load file can contain a software upgrade or other commands that will be executed.
11. **LOAD + BACKUP** is pressed simultaneously to restore the latest backup stored on the SD-card.

11.1 Power Supply

UltraBase30 is powered by 24 V DC, through the terminal marked **+24V** and **GND**.

Requirements and characteristics of the unit's inputs and outputs can be found in the table below.

Port	Supply	Supply Expansion module (port Ex)
+24V/GND	24 VDC* (>300 mA)	24 VDC, 1A

* Stabilized DC voltage.

12 The unit UltraBase40

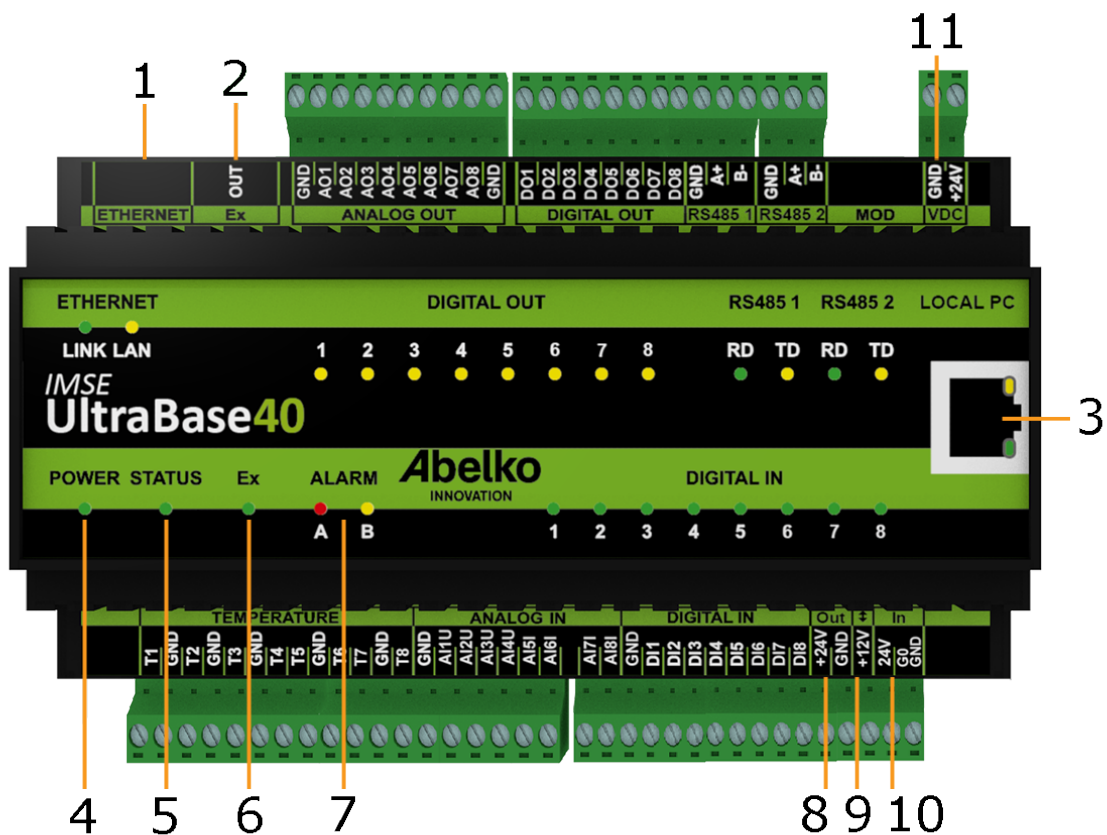



1. **ETHERNET** is used to connect to the network.
2. **Ex OUT** is used to connect to expansions modules. This port can also be configured as an RS485-port.
3. **LOCAL PC** is used only for direct connection to a PC with address **https://192.168.142.1**.
4. **POWER** shines green when the unit is powered.
5. **STATUS** shines green when the unit is running. It may take a little while before STATUS lights up when the unit is powered. If it does not light up, inputs and outputs are not working. If the status LED blinks, there is something wrong, go to menu Active Alarm for more information about the error.
6. **Ex** shines green when all the expansion modules that should be connected are running. If it blinks, a module is missing. Ex does not shine if the port is configured as RS485
7. **ALARM** has one red LED for A-alarms and one yellow LED for B-alarms. The LEDs blink if there are alarms that need to be acknowledged.
8. **Out** +24 V output

9.  **(+12V)** is used to power the Ultra with 12 V stabilized DC, or as a +12 V output when the Ultra is powered from another port. Ex OUT is not powered on +12V power.
10. **In** is used to power the Ultra with 24 V AC power. Ex OUT is not powered on AC power.
11. **VDC** is used to power the Ultra with 24 V stabilized DC.

12.1 Power supply

UltraBase40 can be powered in several ways. Requirements and characteristics of the unit's inputs and outputs can be found in the table below.

Port	Supply	Supply expansion module (port Ex)	24 V out (port Out)	 (out +12V)
 (in +12V**)	12 VDC* (>300 mA)	No	No	Not available
VDC	24 VDC* (>300 mA)	24 VDC, 1A	24 VDC, 100 mA	12 VDC, 100 mA
24VAC	24 VAC (>300 mA)	No	No	12 VDC, 100 mA
24VAC	24 VDC* (>300 mA)	No	No	12 VDC, 100 mA

* Stabilized DC voltage.

** Use GND from the port Out. The Power LED lights up when the device is energized and the Status LED lights up when the device has started up and is working.

13 Term Definitions

Acknowledgment: a confirmation that you have received and noticed an alarm.

Alarm: an alarm is always created based on a channel and monitors the channel's value according to set conditions and limits. A-alarm has a red indicator and B-alarm has a yellow indicator. In addition to these, you can choose to give an alarm a priority from C-Z and they have a blue indication.

Alarm groups: manages alarm sendouts and makes it possible to create features for multiple alarms at the same time.

Application: builds the functions in the Ultra. An application contains graphical programming or script and resources such as channels, parameters, curves, all of which are visible in the graphical programming. Overviews and summaries are part of an application. An application can contain other applications, which are subapplications. In the graphical programming, an application is represented as a box with inputs and outputs. You can create an application template, which can be useful if you want to create similar applications.

Application backup: a backup with application templates.

Change history: a log that gives an overview of the changes made by users. Includes a selection of resources in the Ultra.

Channels: handles all the variable data in the unit. Channels are viewed in overviews and summaries and are logged and monitored by alarms. Channels are used for logs and alarm.

Coils: this is a type of a Modbus register. One coil is a 1 bit word.

Components: primitive function blocks in the graphical programming. Connect these with other resources in order to create programs. They exist only in the graphical programming and cannot be reached from other parts of the system.

Curves: a table that is presented as a configurable curve. Curves are used by controllers to do things like converting an outdoor temperature into a flow temperature.

Events/Errors: a type of alarm that is created by the system. It notifies you when something is wrong in the system that may prevent the unit from functioning.

Expansion modules: used to add more inputs and outputs with different features and communicates automatically with the Ultra. You can connect an expansion module and the system will recognize it and its features.

External units: different types of units that an Ultra can exchange information with, as a master. They can be used for more inputs/outputs, meters and more. For example, Modbus and M-bus units can be connected as external units.

File manager: tool that uploads files to the Ultra. There are predefined folders including sensor definitions, communication definitions and backups.

Graphical programming: a tool that creates graphical programs. It enables you to build up an entire system with all of its functions based on the inputs and outputs of the unit.

Holiday catalog: a file that can be used when working with time schedules with rules **Weekly** to change which day of the week specific dates should be counted as, for example Christmas Day should be counted as a Sunday regardless of which day of the week it falls on.

I/O-channels: software representations of real inputs and outputs, and allows you to set scale factors, offset and conversion functions for sensors and actuators.

Logs: store values from selected channels with set intervals. Logged data can be displayed as a plot or exported as a table.

Messages: created by script and is stored in the alarm history. An example of a message is that the system has changed into summer operation.

Modbus: a protocol that is used to communicate between different units. Values are ordered in numbered registers, which can be read and written by a master.

Node tree: contains all the elements in the system arranged in a hierarchical order. If you open an application, you can view what's in it, and further, if you fold out a subapplication, you can view what's in the subapplication.

Overview: provides a quick overview of the plant. You can add present values, alarms and more to this picture. It also allows easy resource editing.

Parameters: store values that are named and set by the user.

Periodic log: this is a log that measures with certain intervals (1 second, 2 seconds, 15 seconds, 1 minute, 5 minutes, 15 minutes, 1 hour or 12 hours). These can measure momentary values, mean value, max value, min value or a sum of a certain period.

Register: a type of Modbus register; one register is a 16 bits word.

Sensors and actuators: physical units that are connected to inputs and outputs.

Smart log: a log that compresses the data that comes in. Second values are converted to minute values and so on. This allows you to store data for a longer period.

Summary: a view with selected channels, parameters, alarms, alarm groups, curves, time schedules and databases. Here you can see their values and change their settings.

System backup (a full backup): a backup containing all of the system's settings and databases, including network settings and users.

Time schedules: used to set when something should be active or inactive. You can add rules that can be repeated weekly, monthly, early or with a free adjustable interval. You can also select not to repeat the rule at all or only set for a specific date.

Universal input: inputs that measure different kind of quantities (resistance, current and voltage).